

РАСКРАСКИ ПЛЮС!

РАСКРАСКИ - ПРОПИСИ

Скажи, герой какой сказки
изображён на этой картинке.

1

б б

6 6



Проведи карандашом точно по линиям,
постарайся не отрывать карандаш от бумаги.
Раскрась картинку.

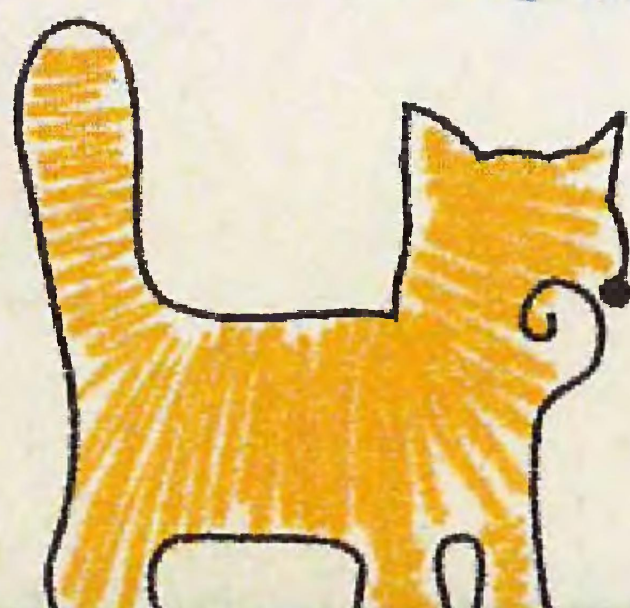

Л
ЛЕВ



Перед тобой все буквы нашего алфавита. Обведи в кружочек те из них, которые составляют твоё имя. Раскрась картинку.



A

Антилопа

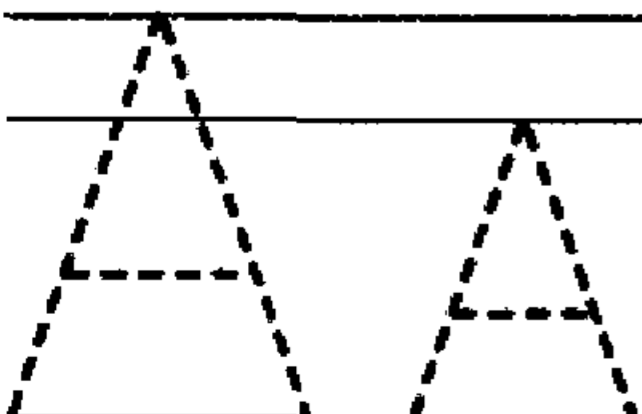
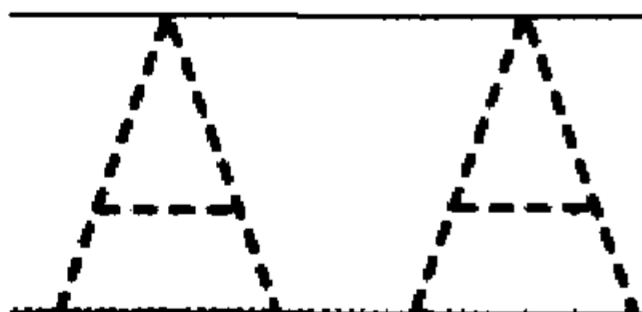
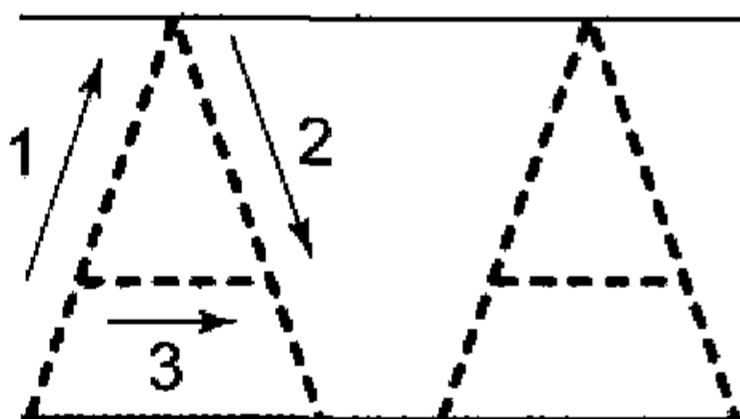
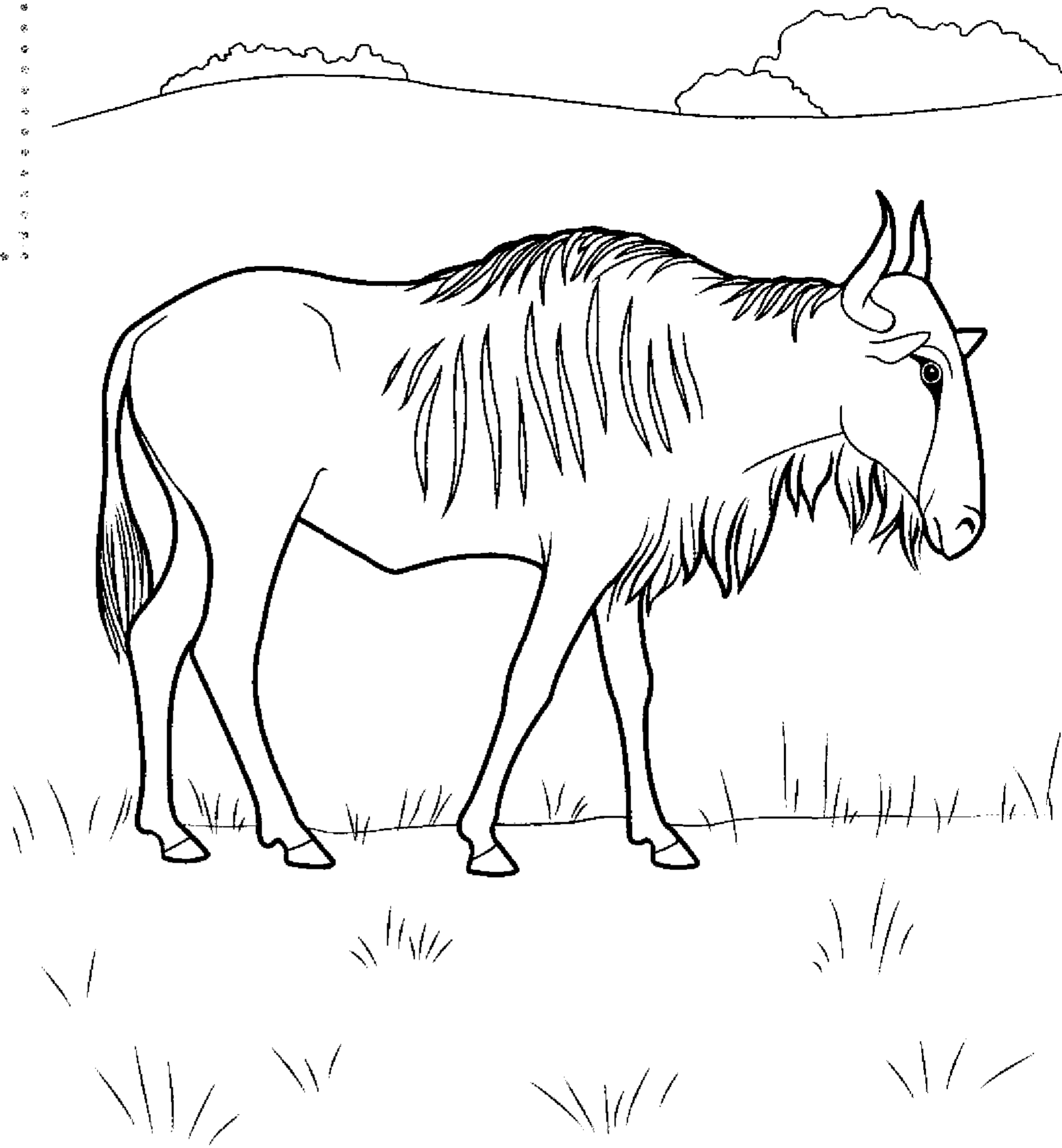

Дорисуй фигуры до конца строки и раскрась их.

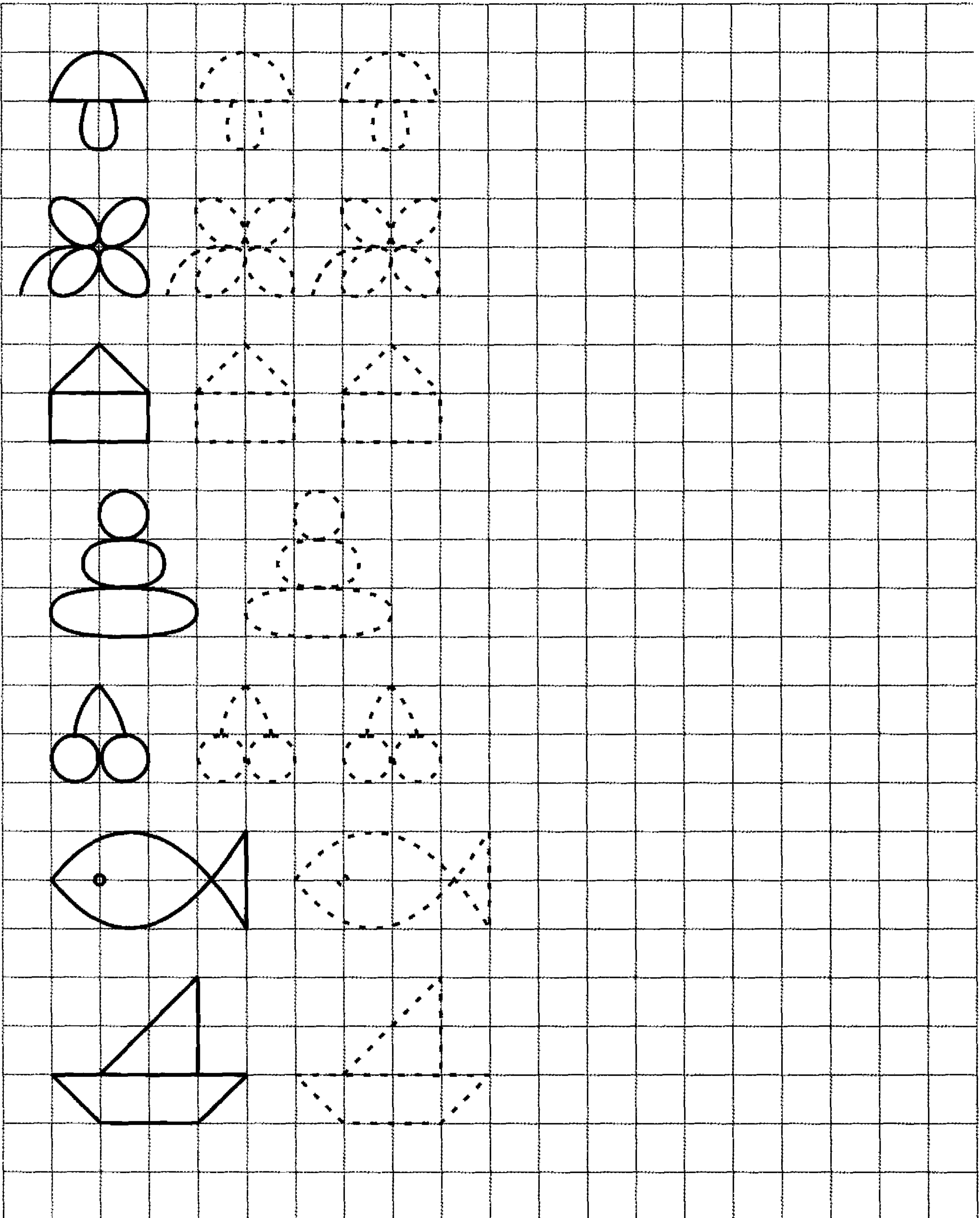

Б

Белка

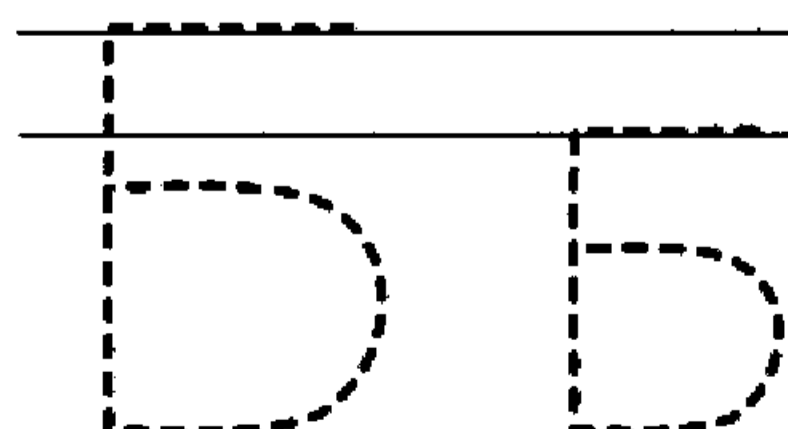
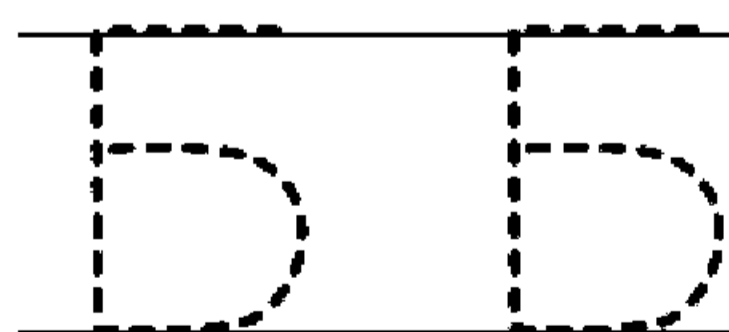
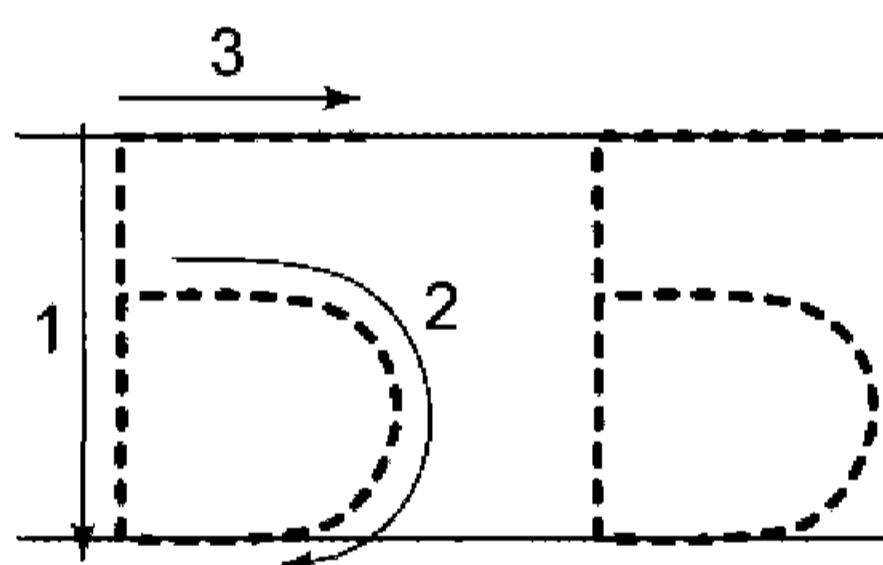

Проведи карандашом точно по линиям, постарайся не отрывать карандаш от бумаги. Раскрась картинки.

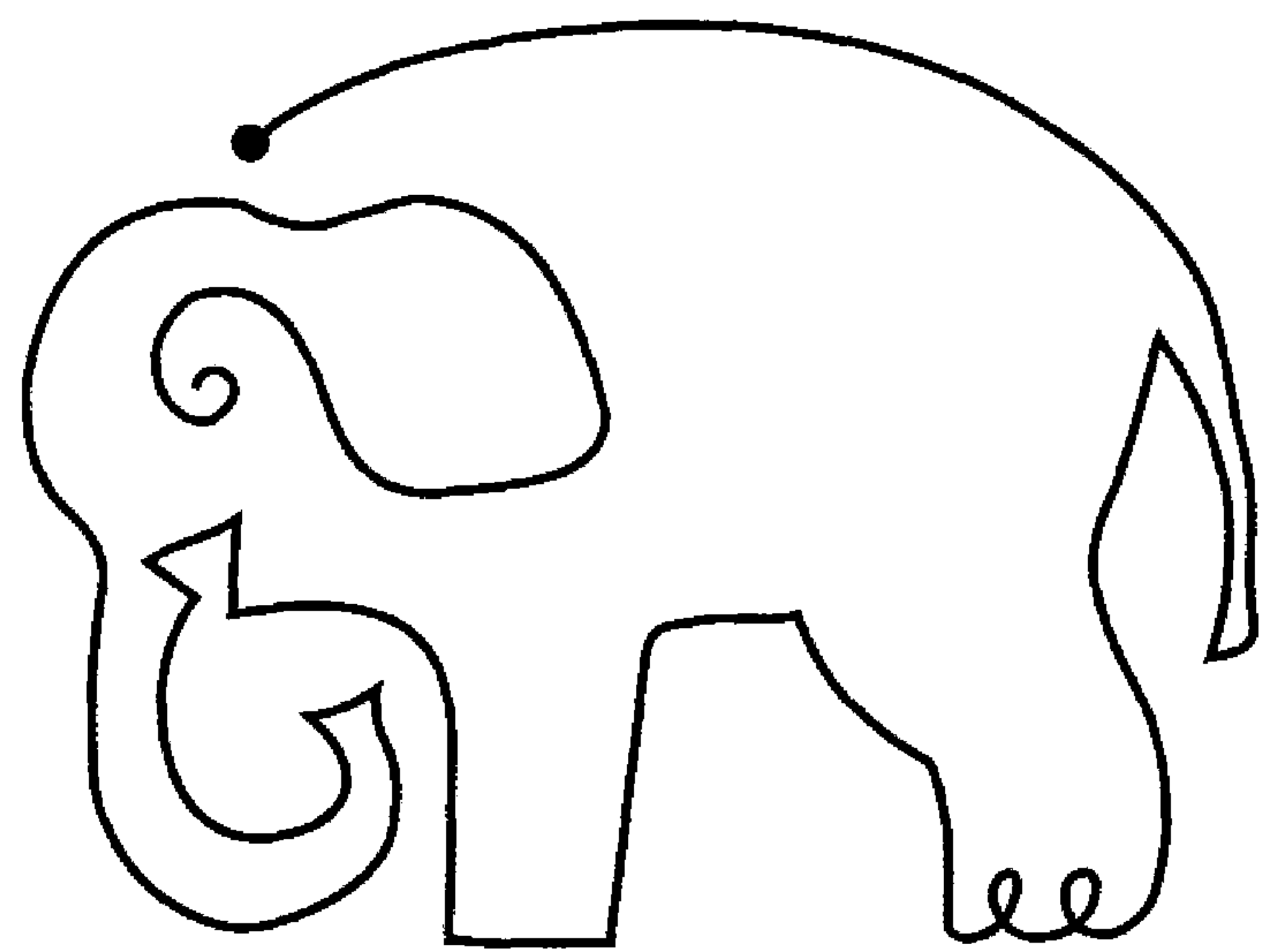
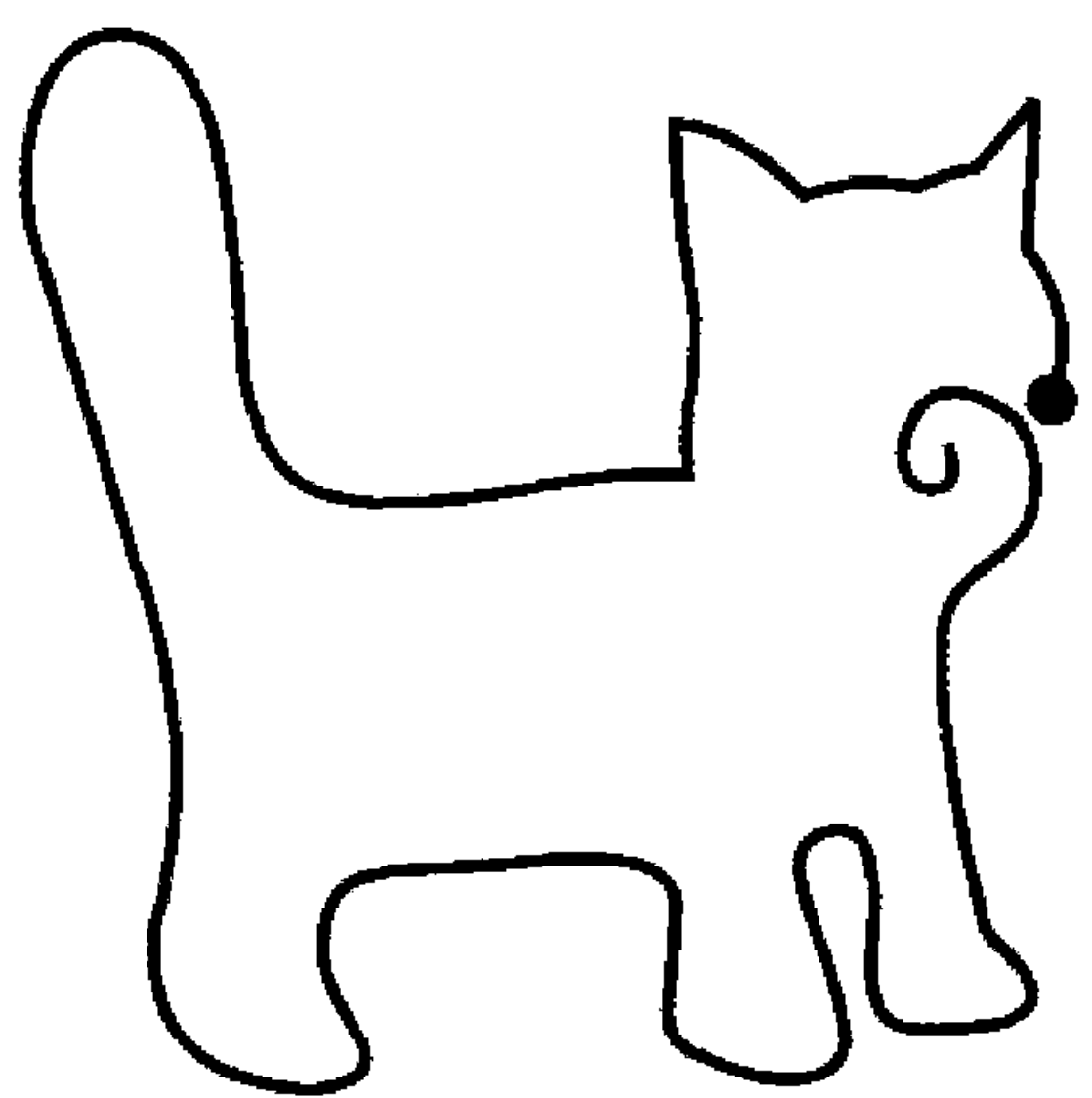
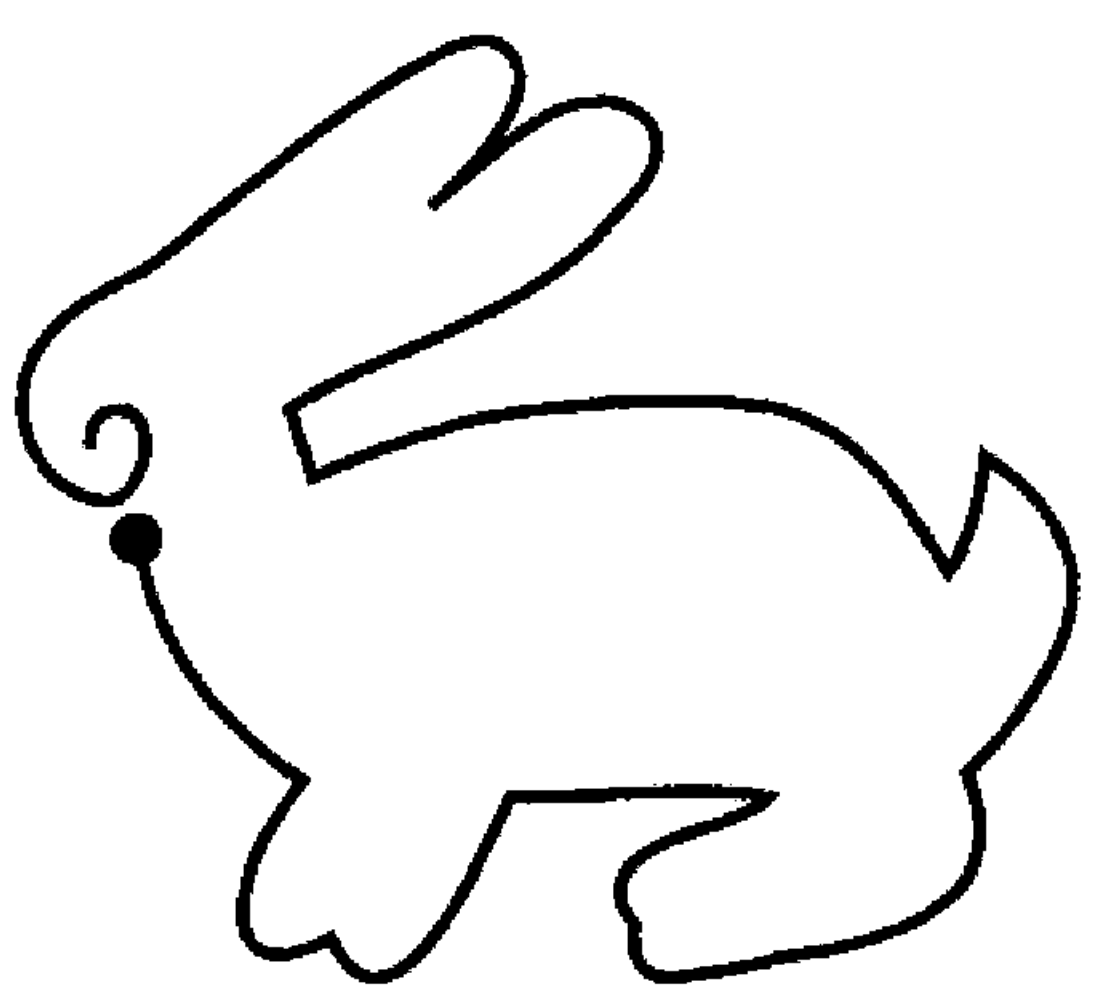
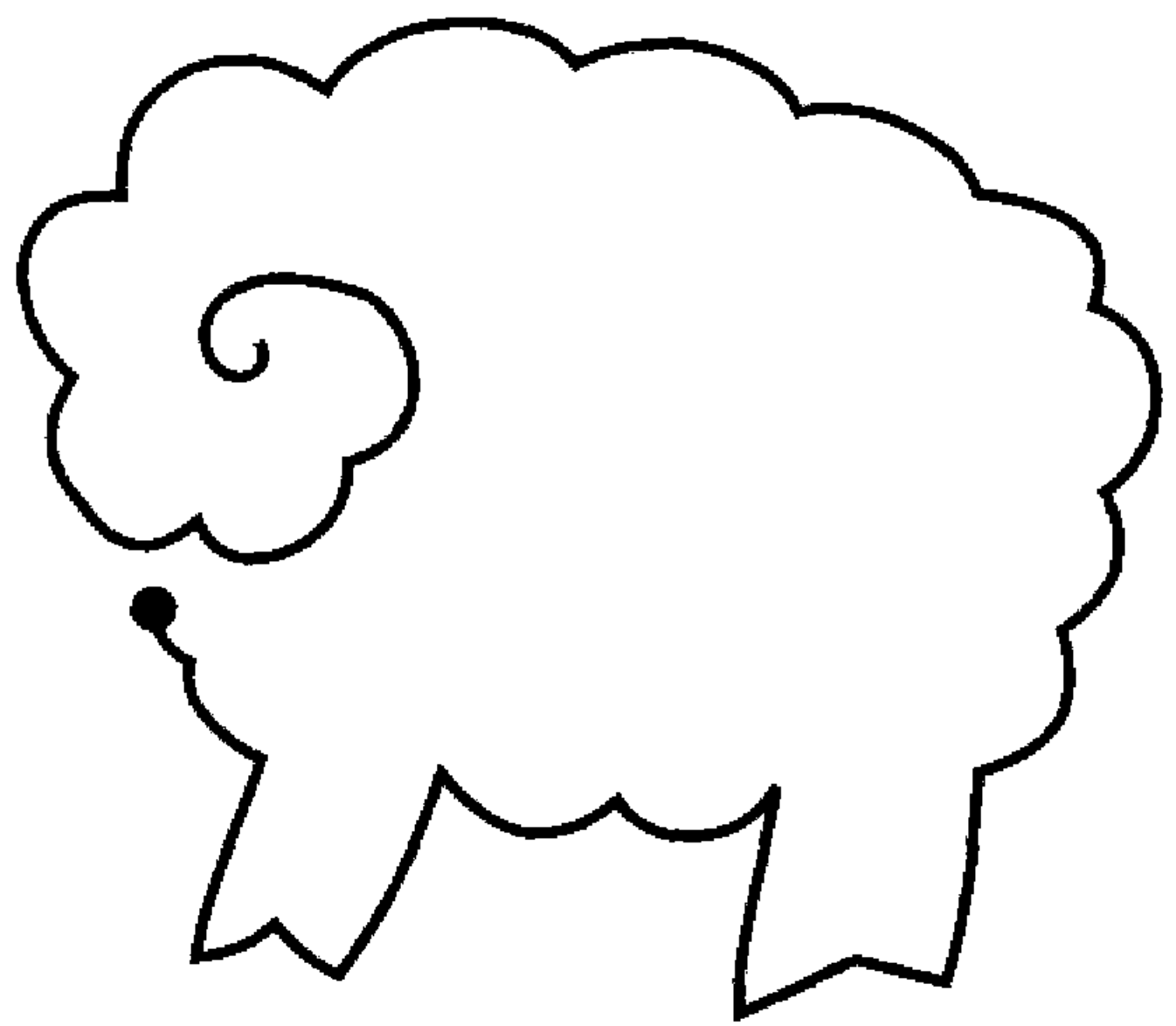
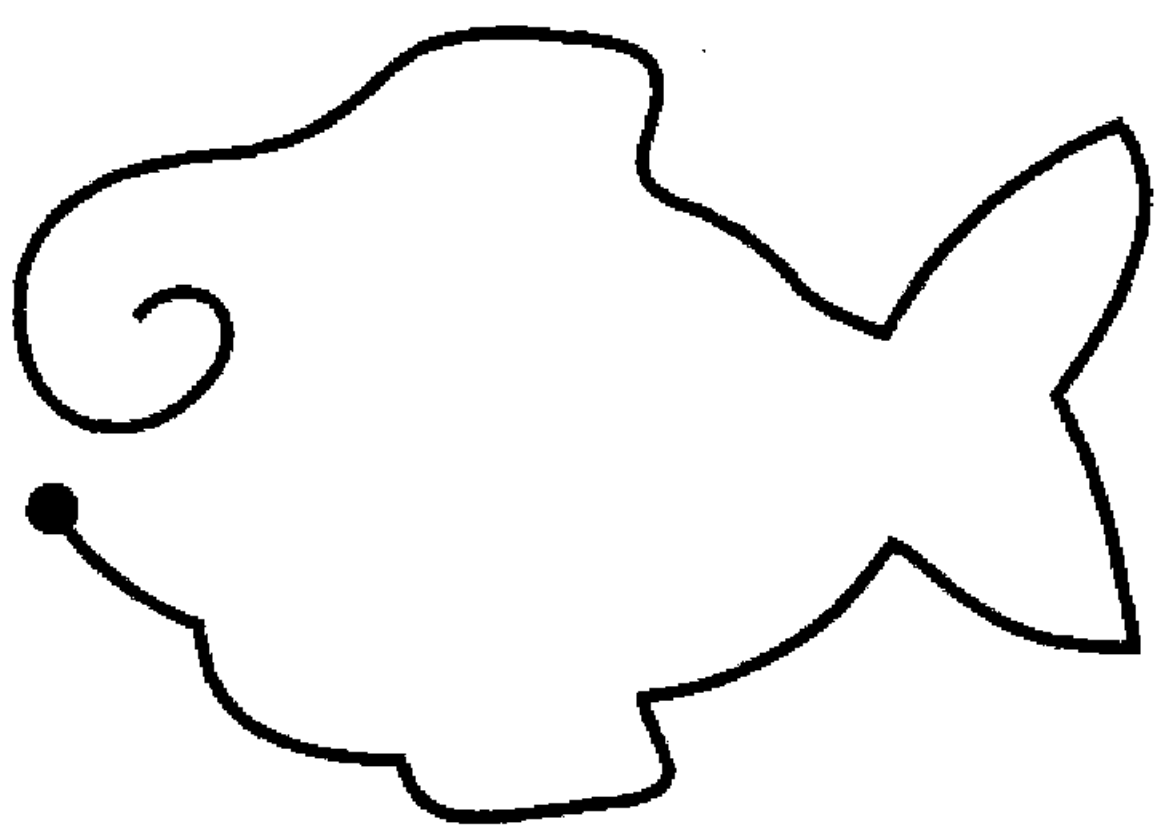

В

Верблюд

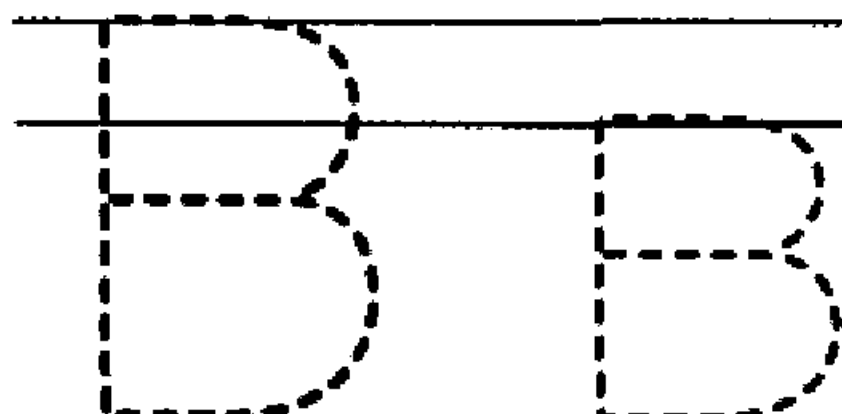
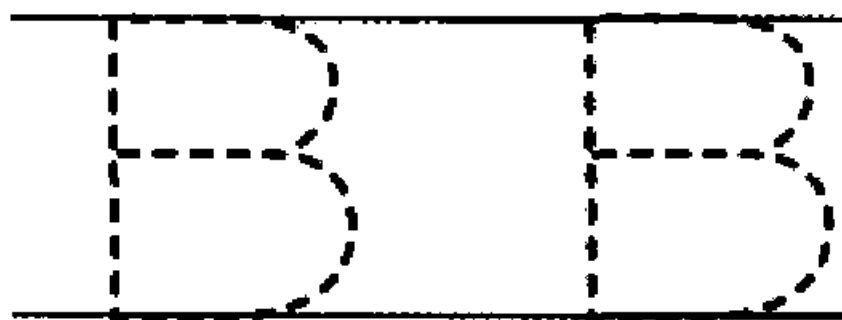
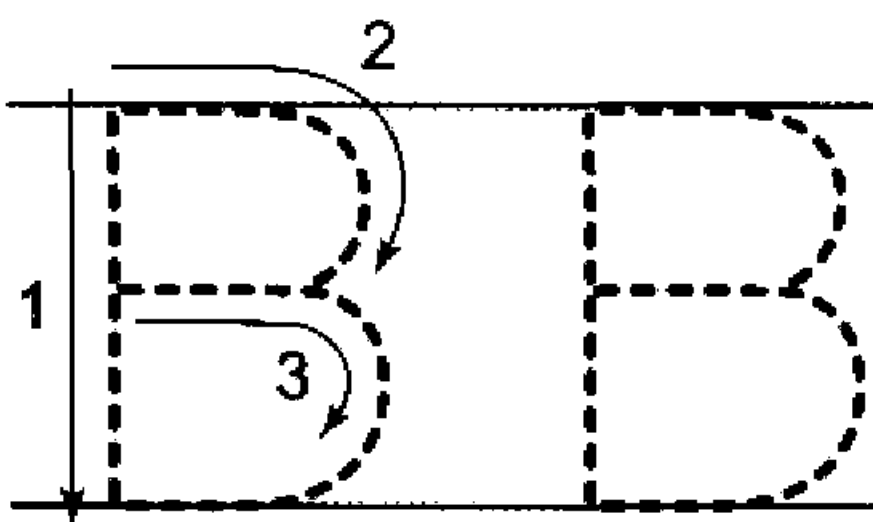
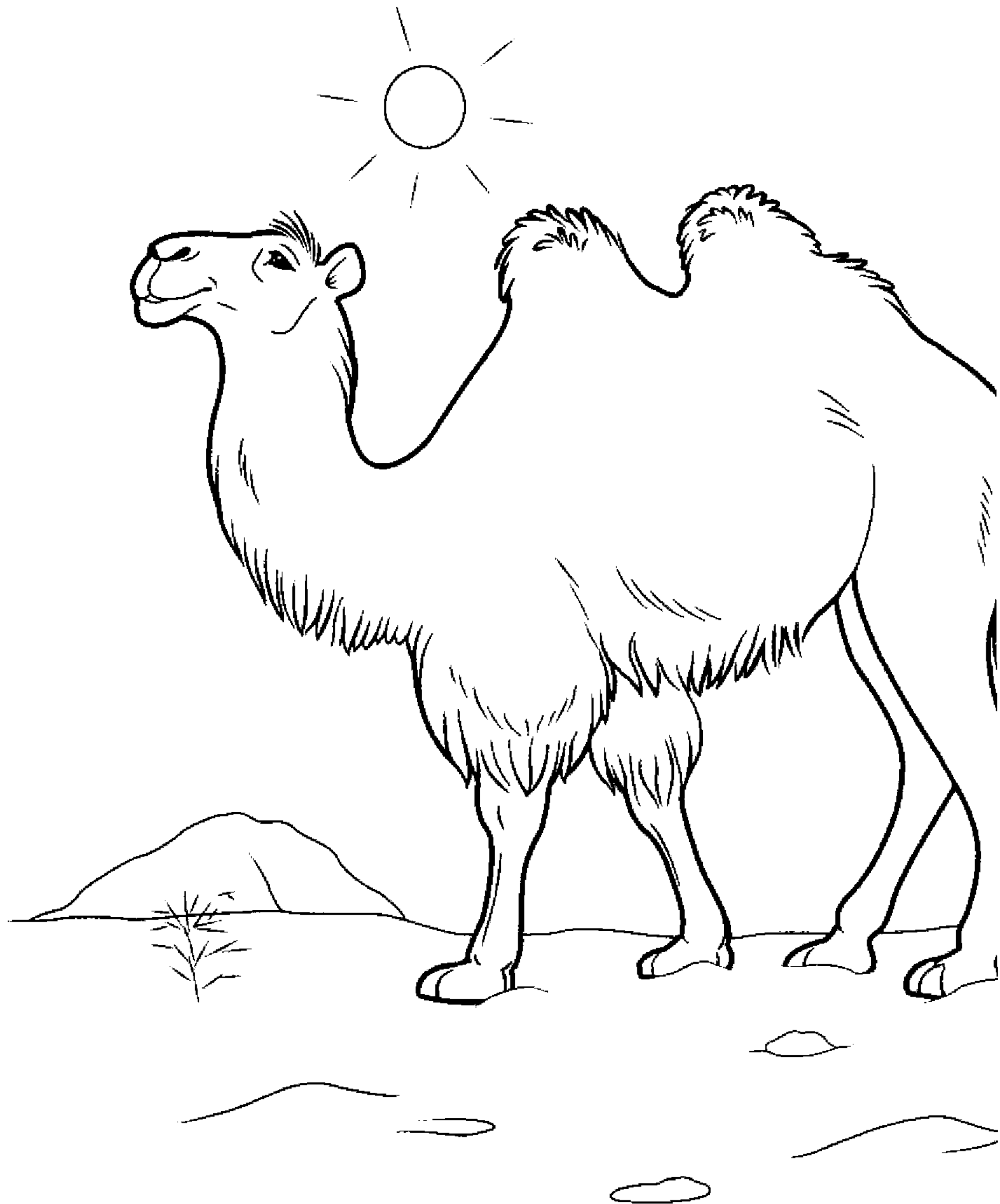

Дорисуй вторые половинки предметов и раскрась картинки.

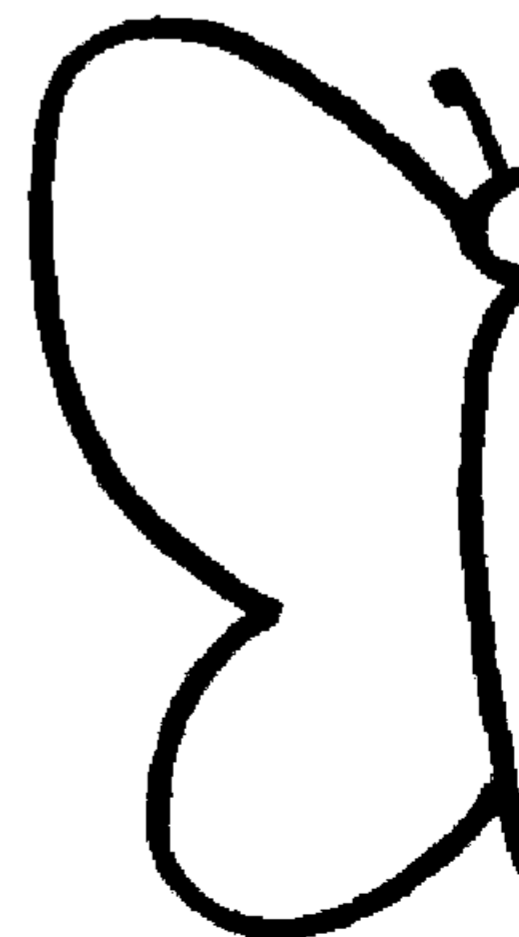
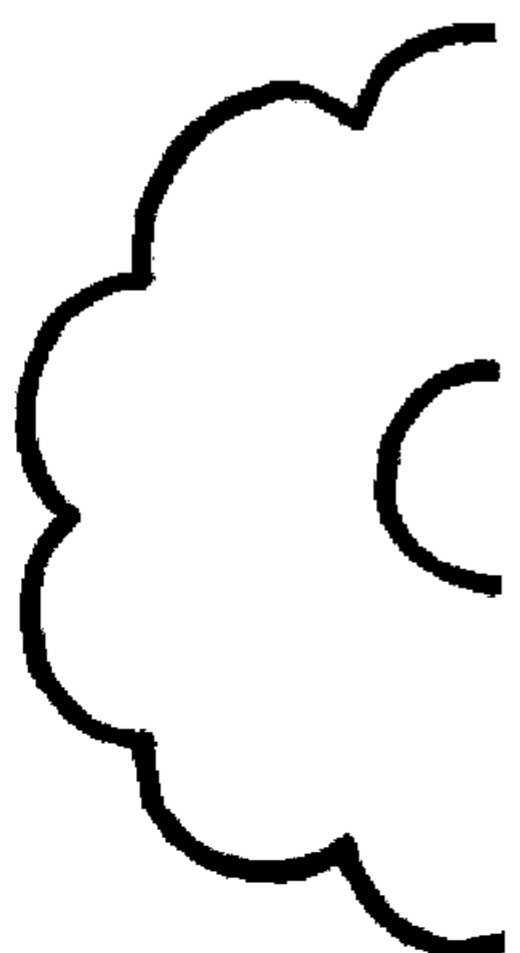
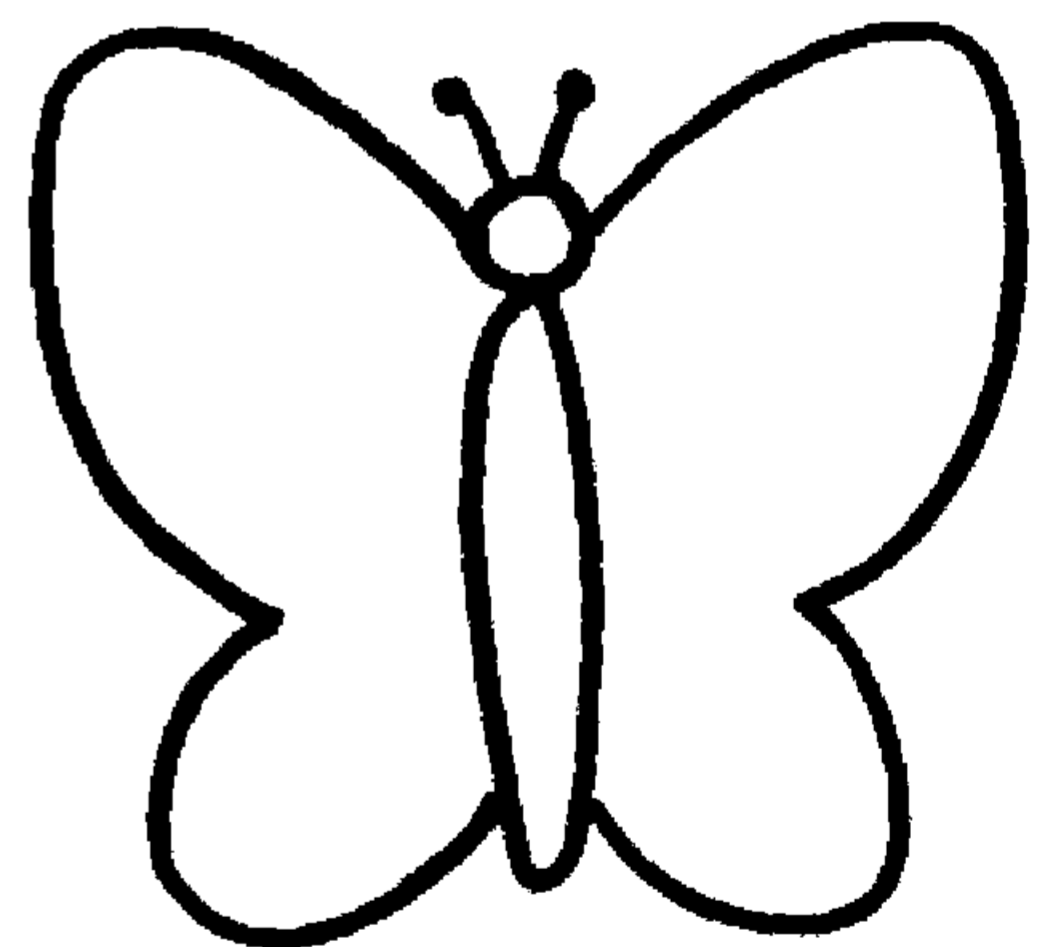
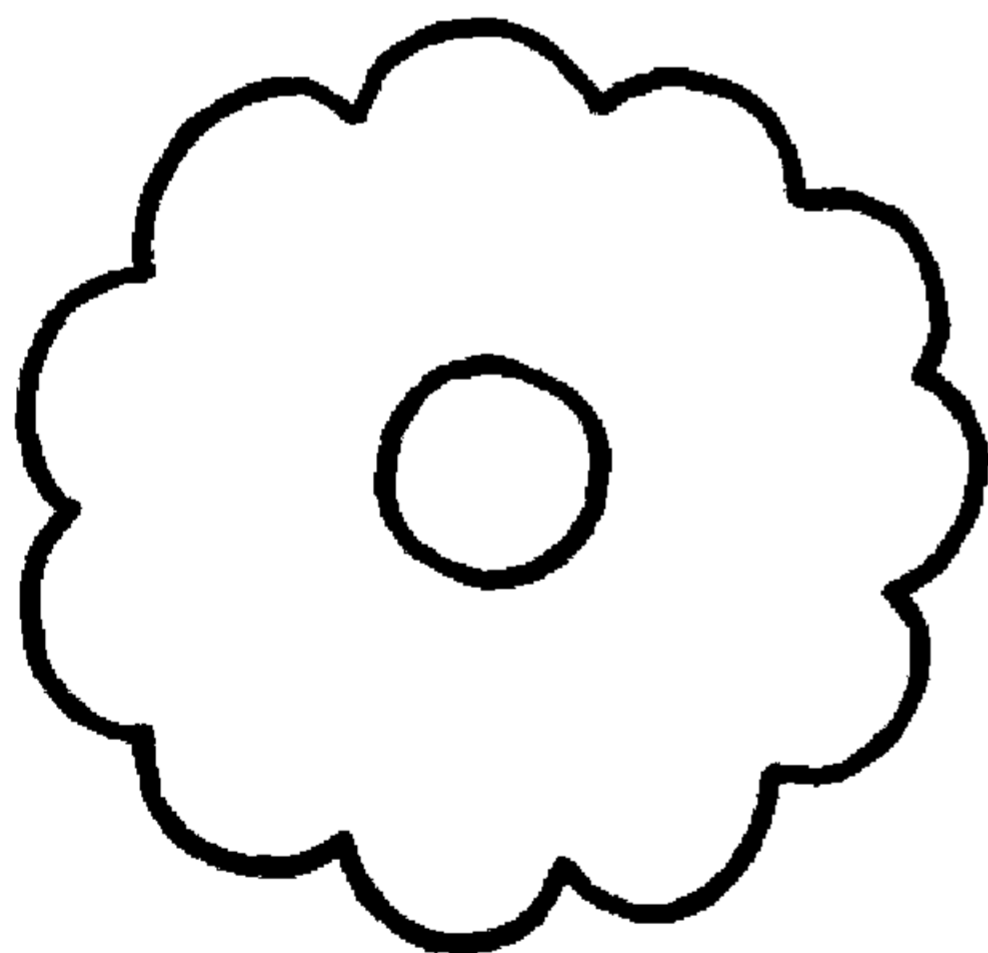
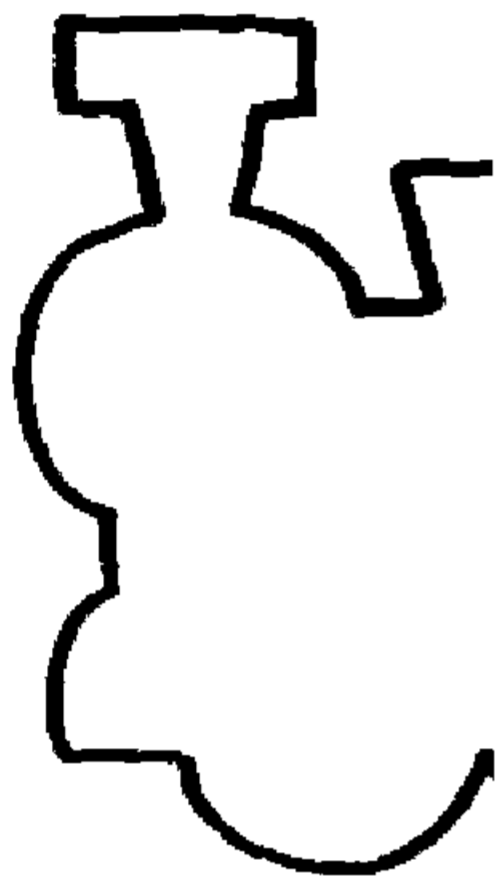
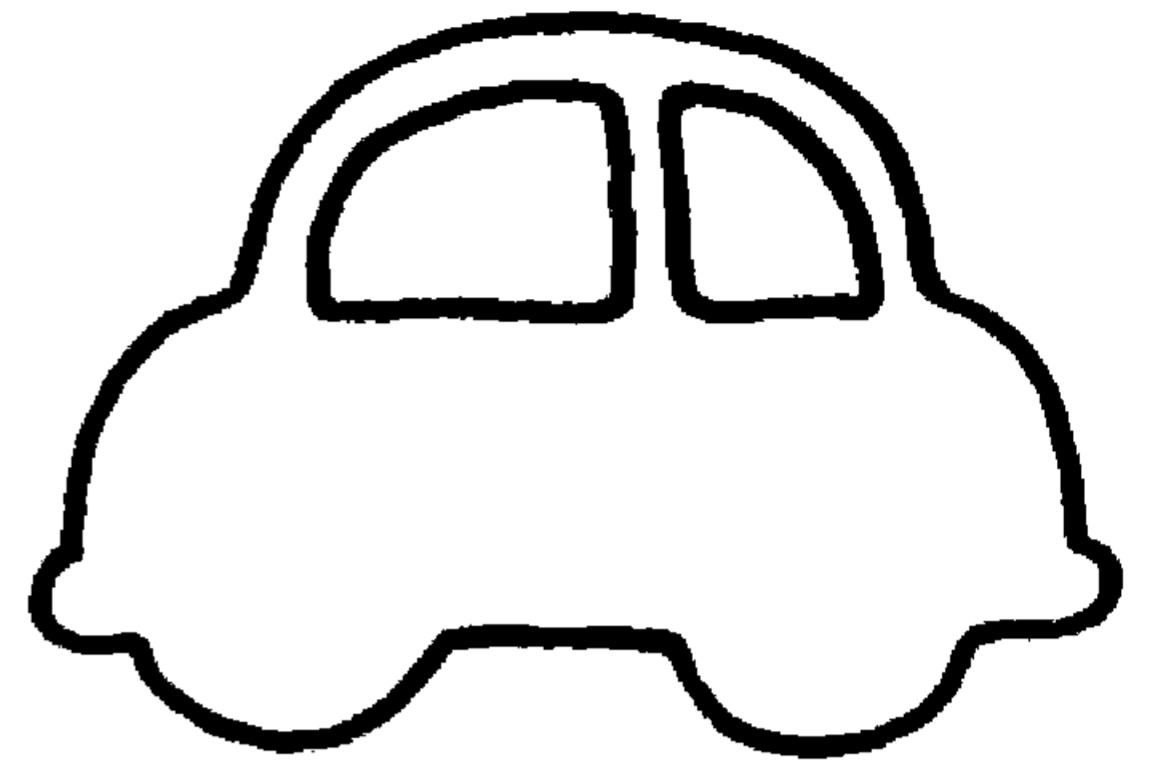
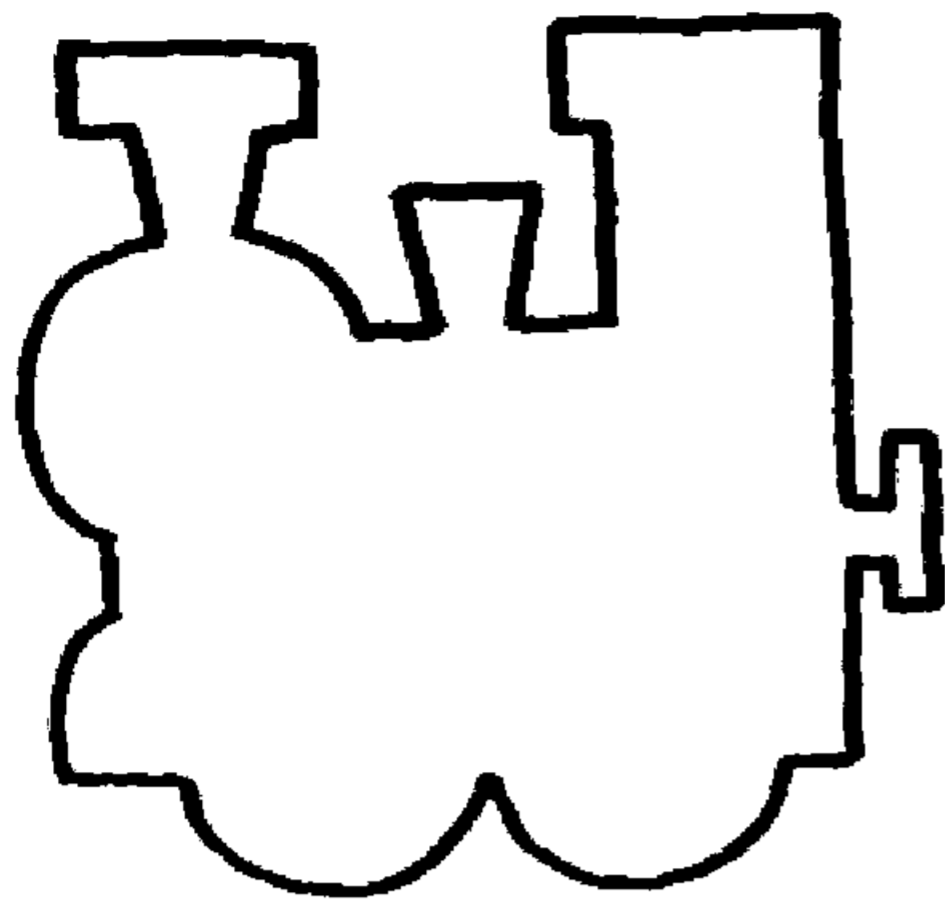

Г

Глухарь

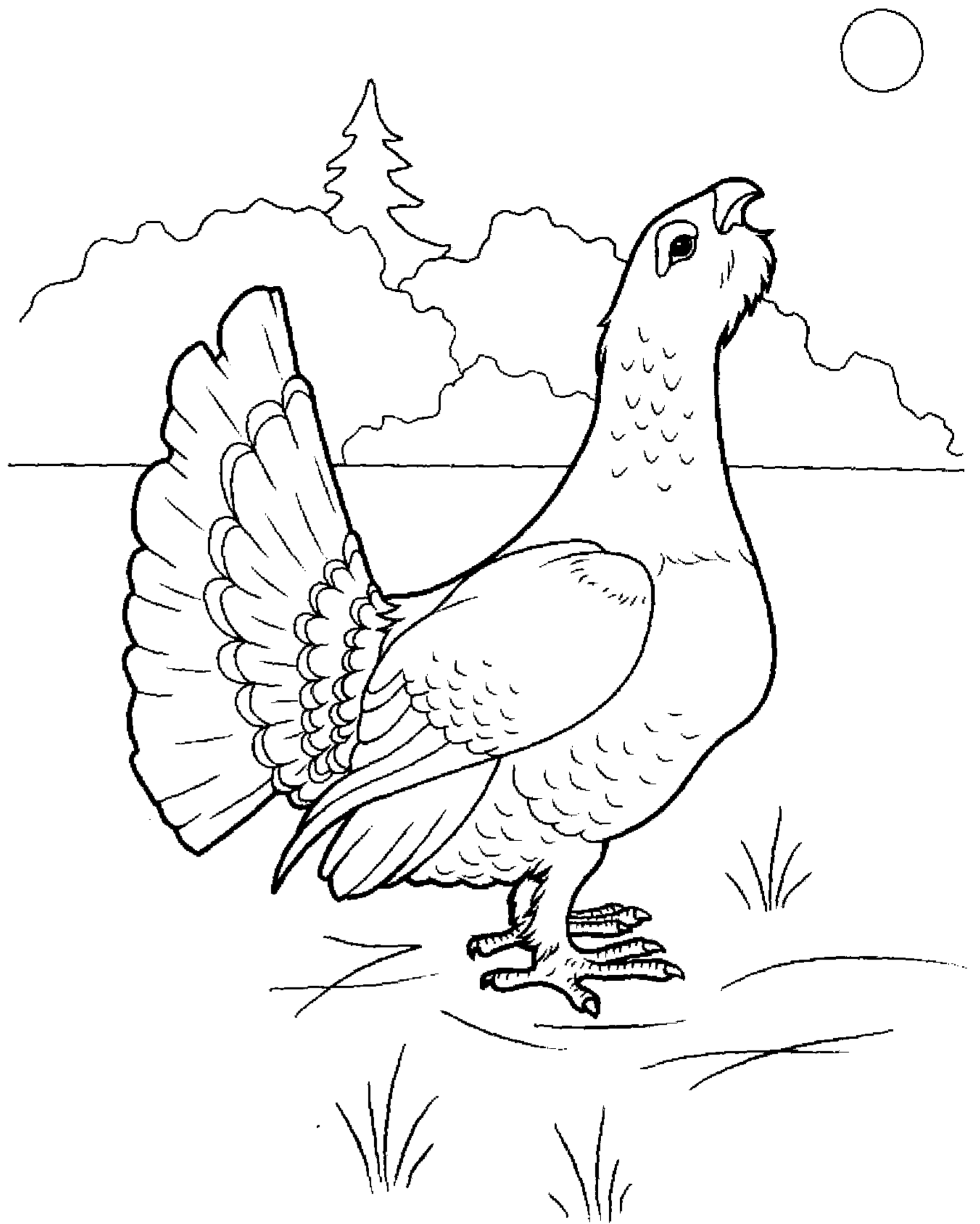

2 →

1 ↓

| | |
|--|--|
| | |
| | |
| | |
| | |

Нарисуй справа по клеточкам точно такие же предметы и раскрась их.

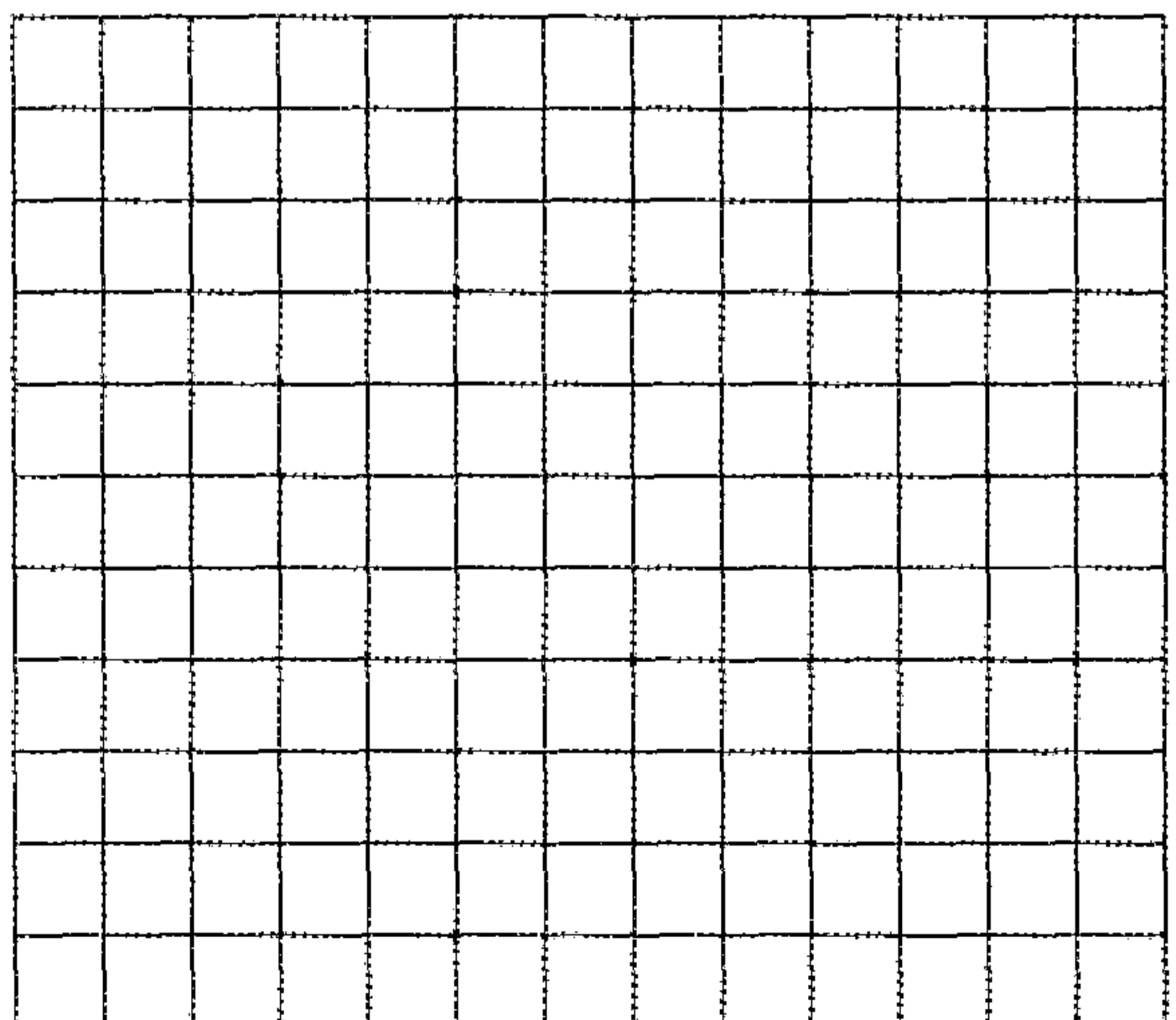
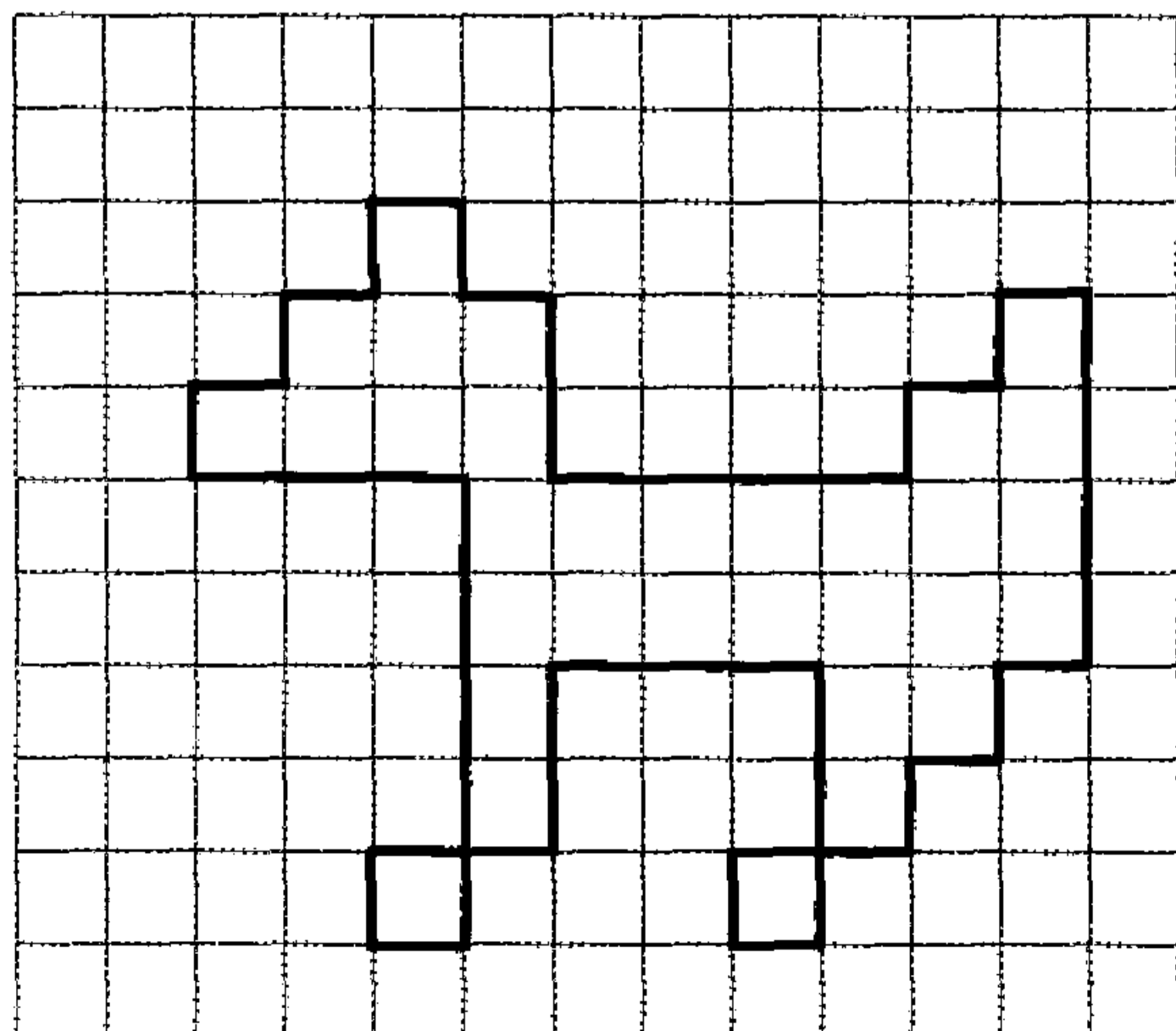
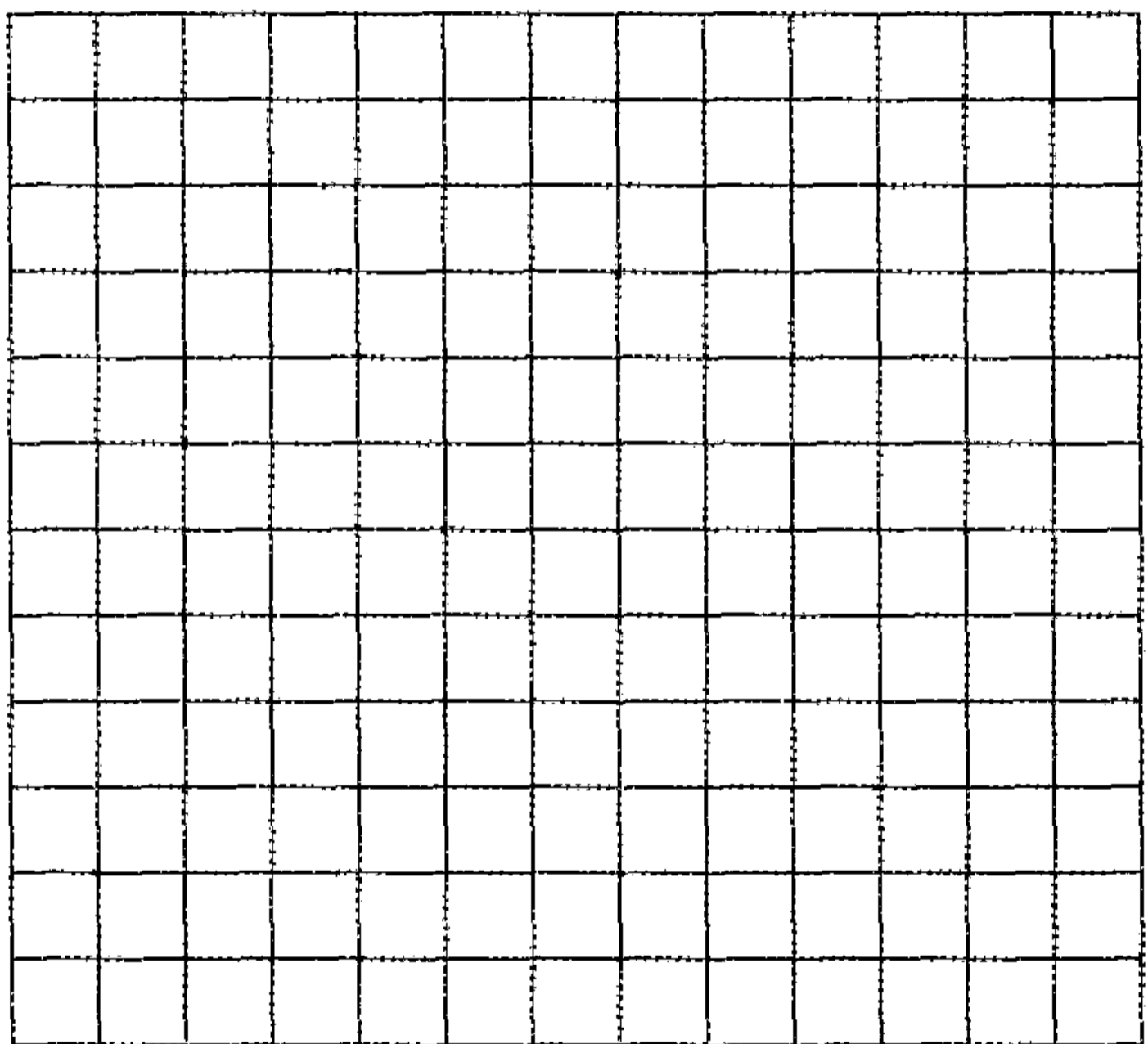
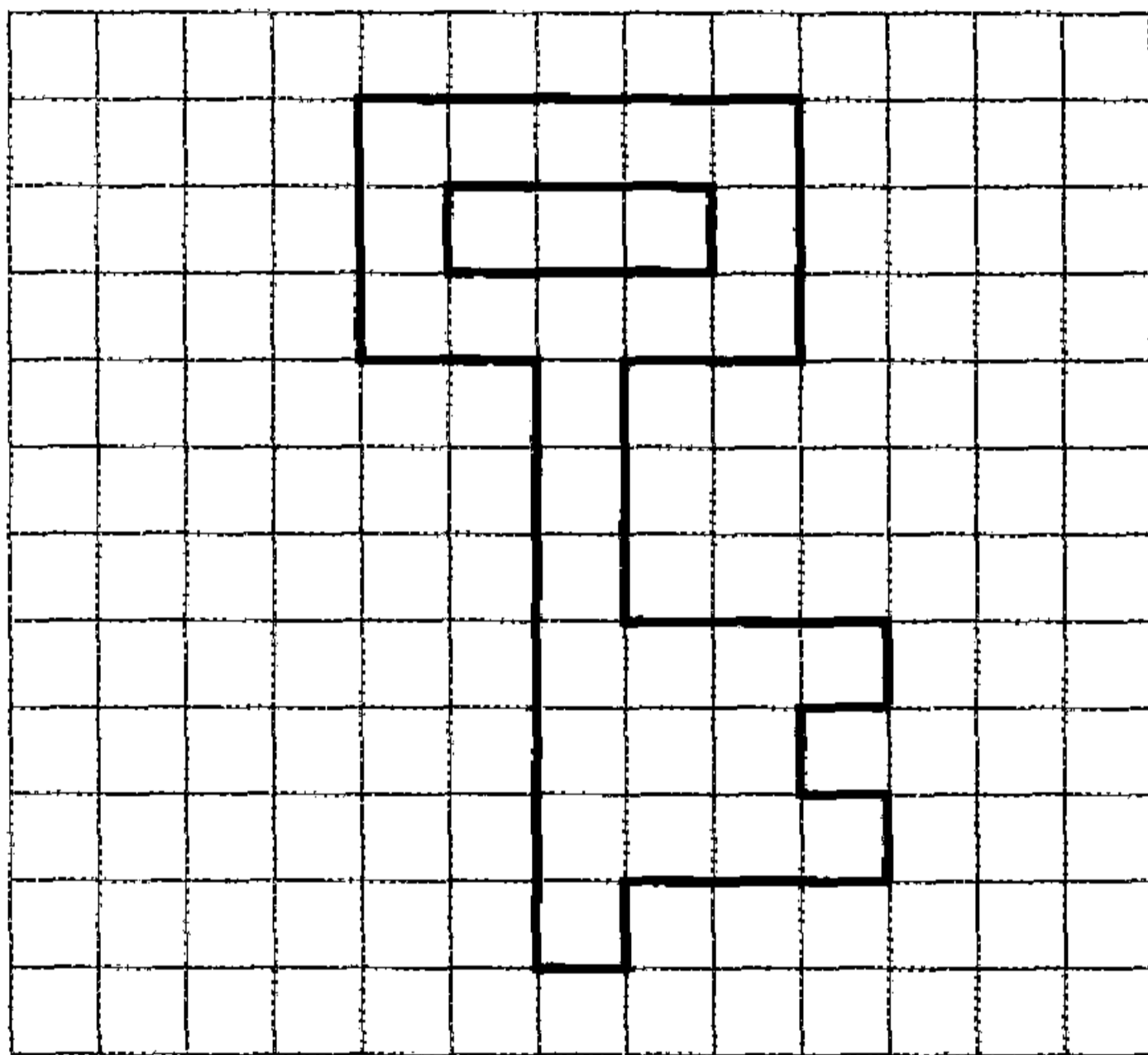
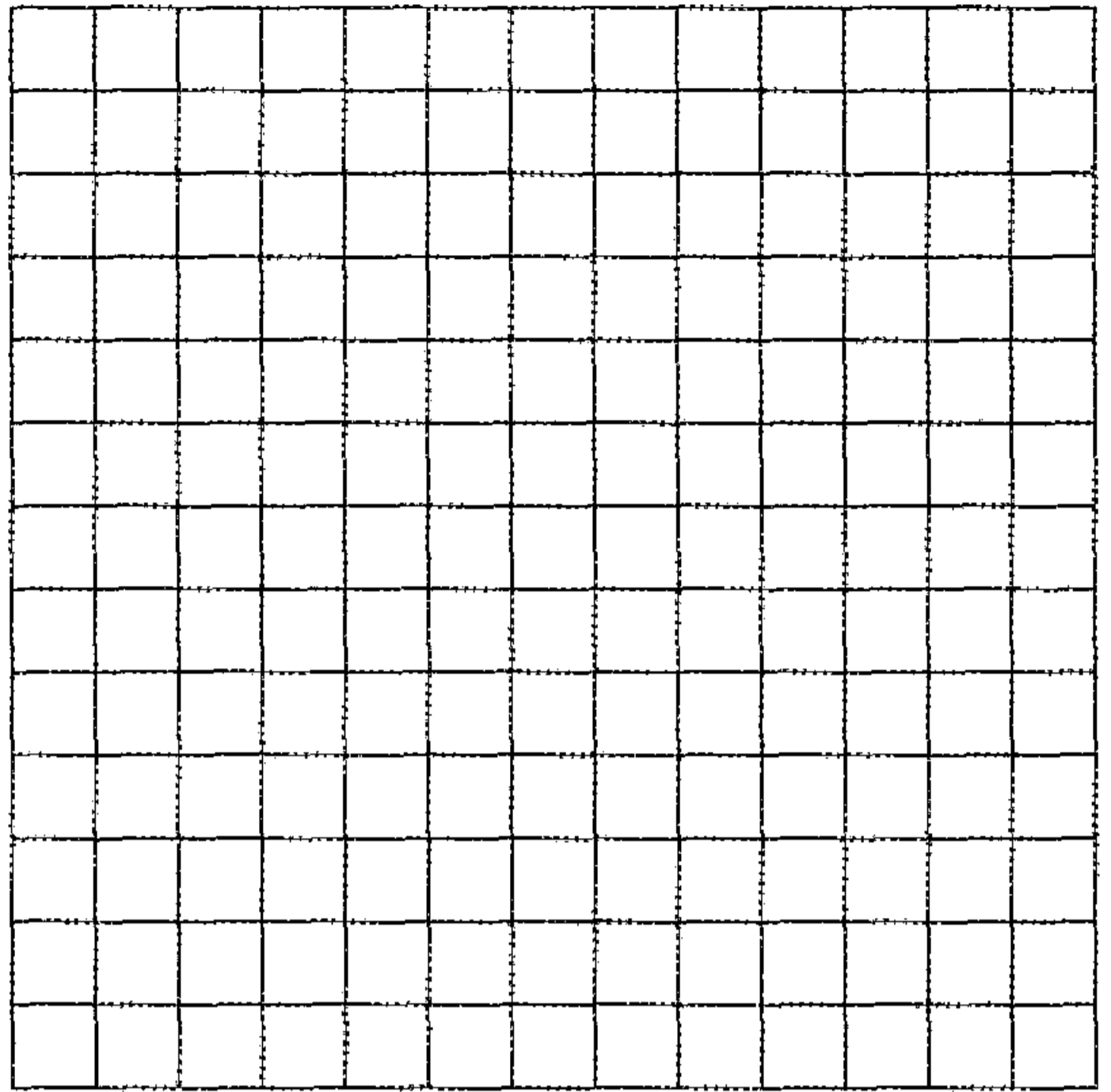
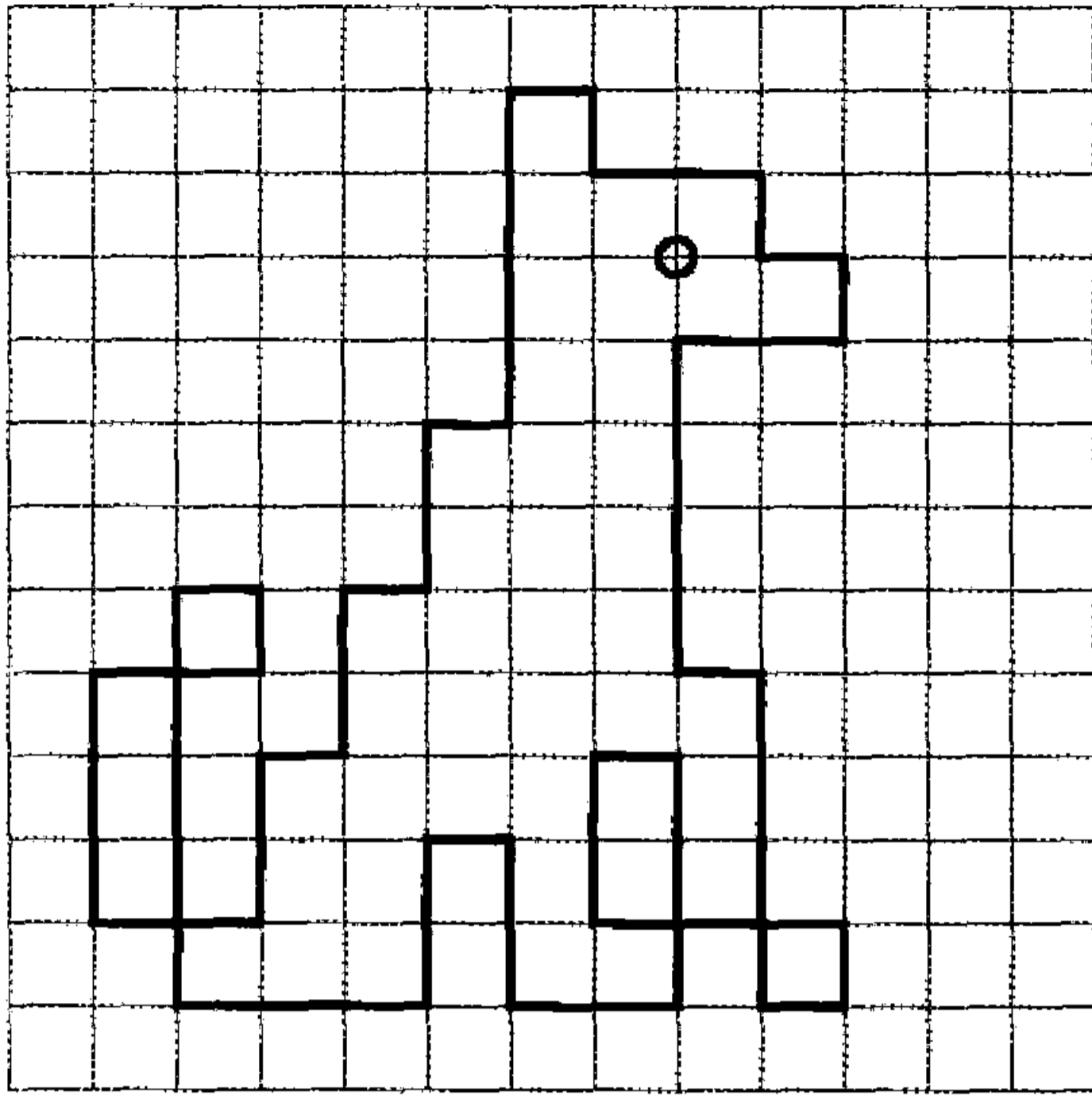

Д

Динозавр

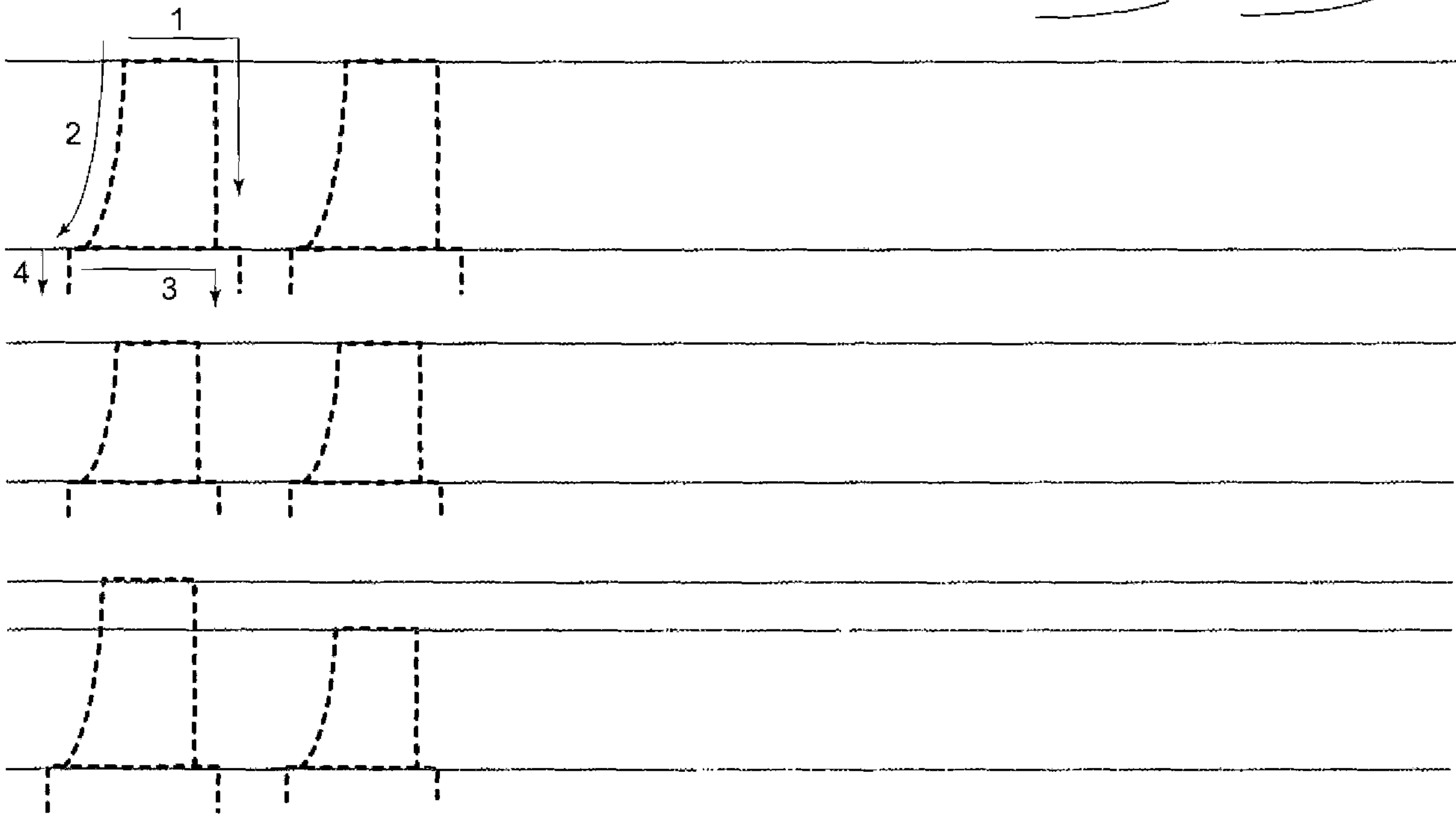

Выполни штриховку прямыми линиями, не выходя за контур рисунка. Раскрась картинки.

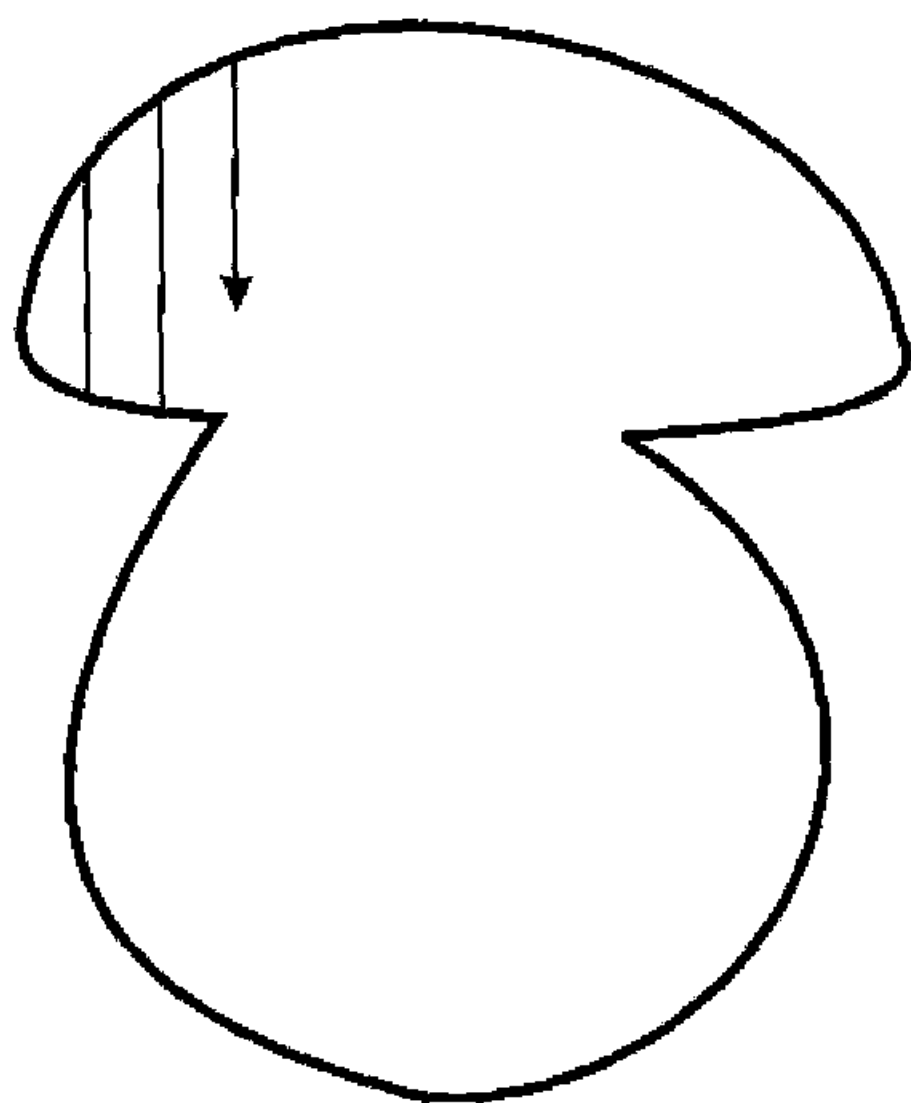
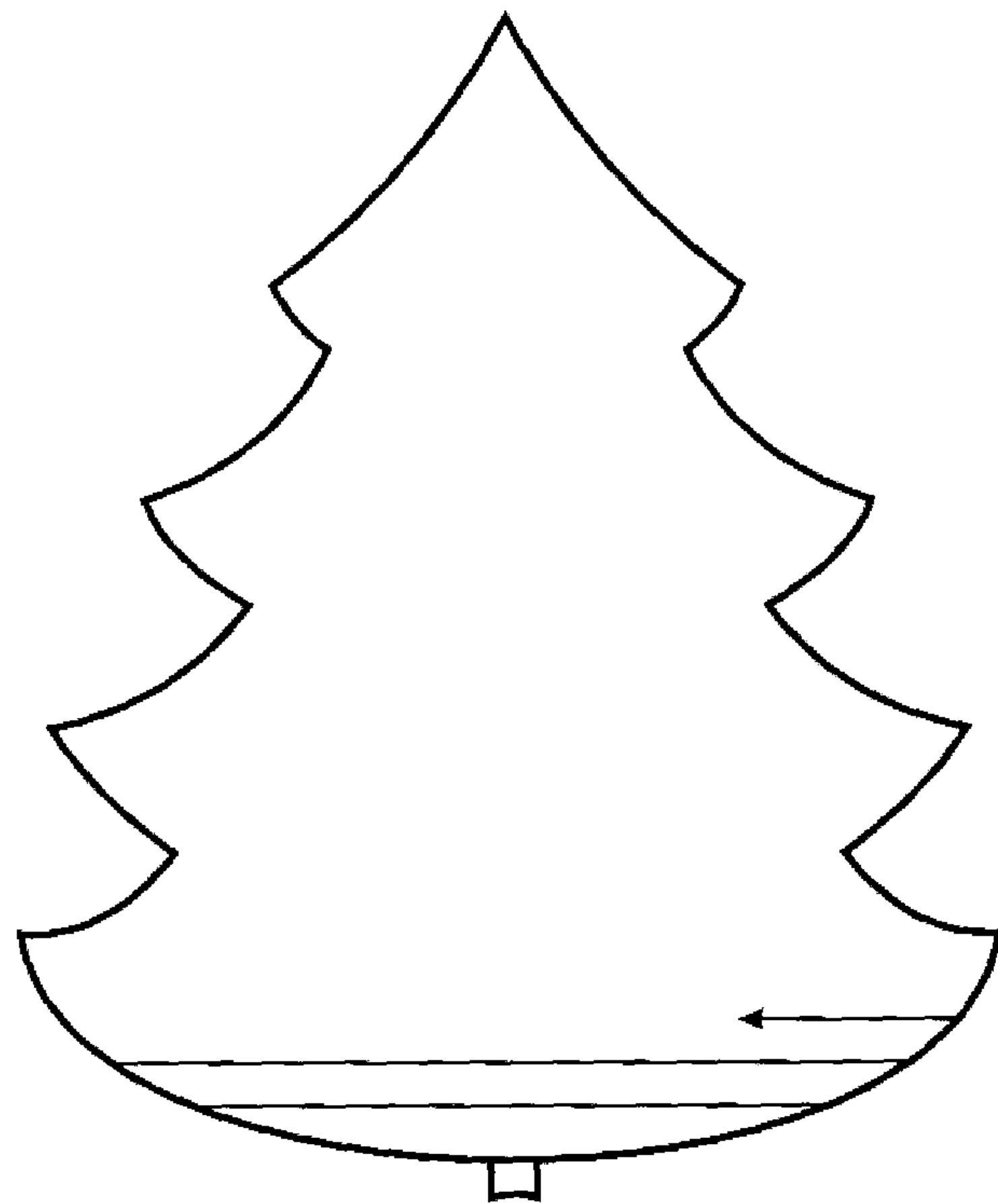
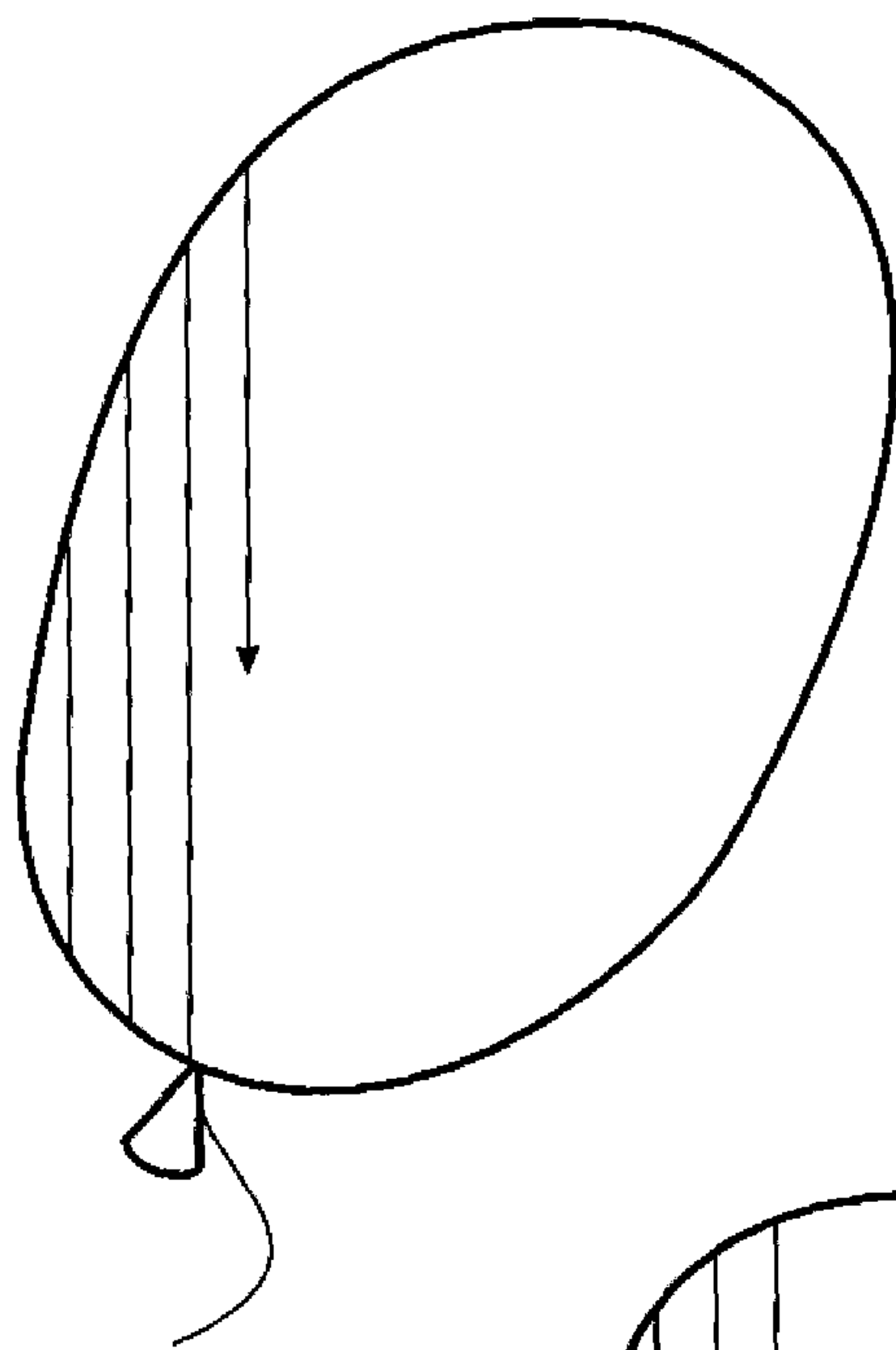
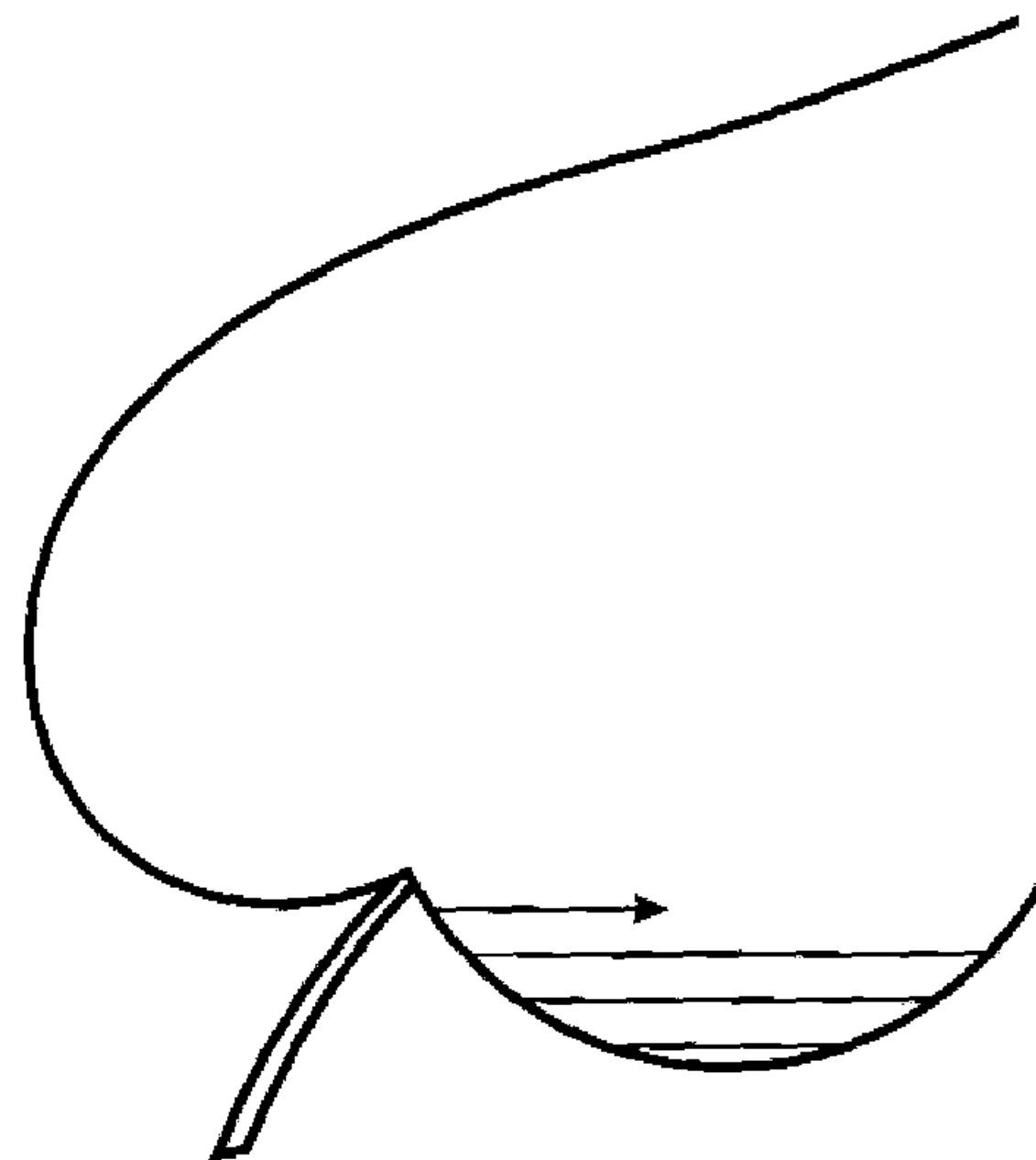
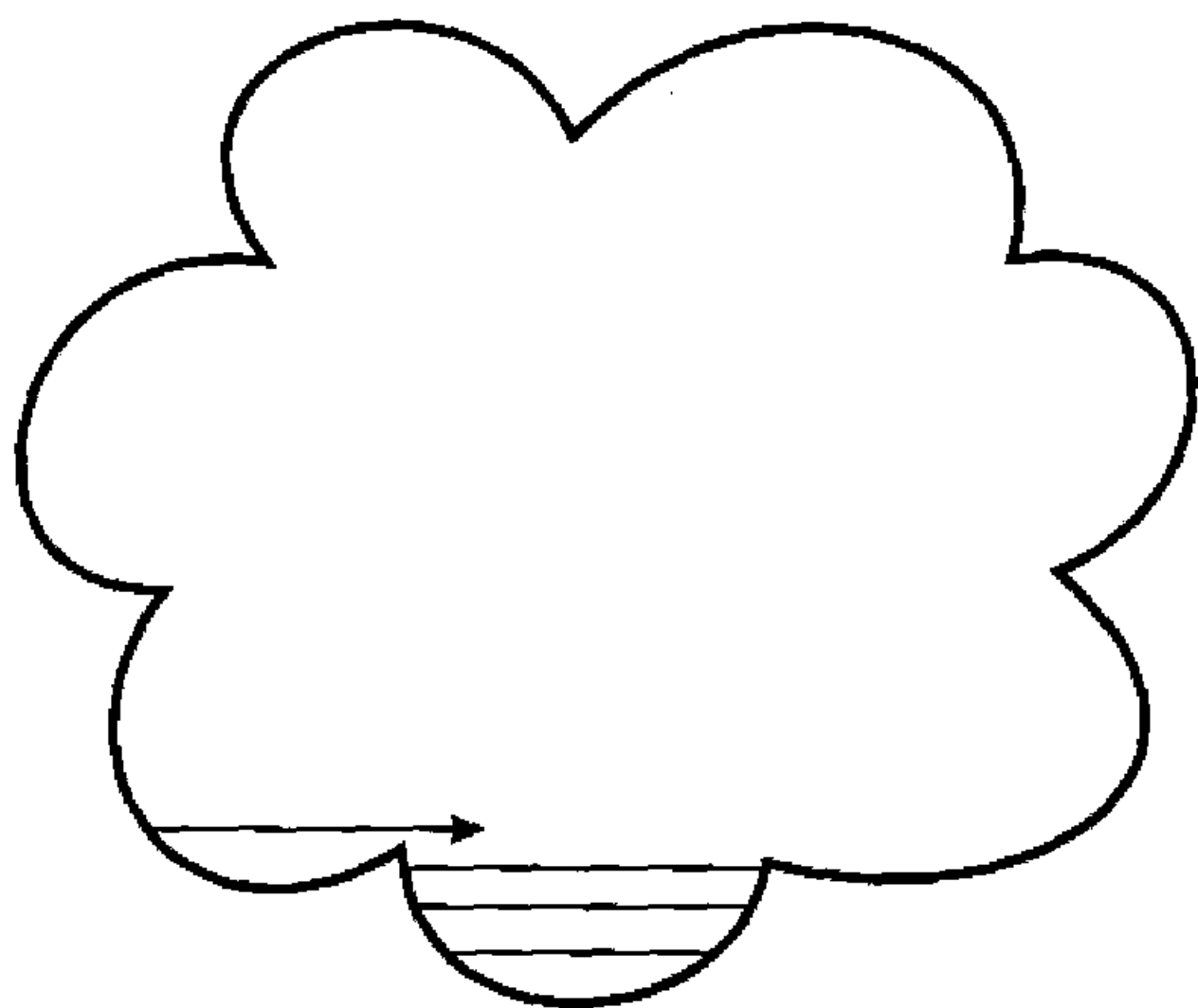

E

EHOT



Tracing guide for the uppercase letter 'E' on a four-line grid. The first row shows the stroke order: 1 (downward vertical line), 2 (top horizontal line), 3 (middle horizontal line), and 4 (bottom horizontal line). The second row contains two dashed 'E' characters for tracing. The third row contains two more dashed 'E' characters for tracing.

Обведи и раскрась орнаменты.

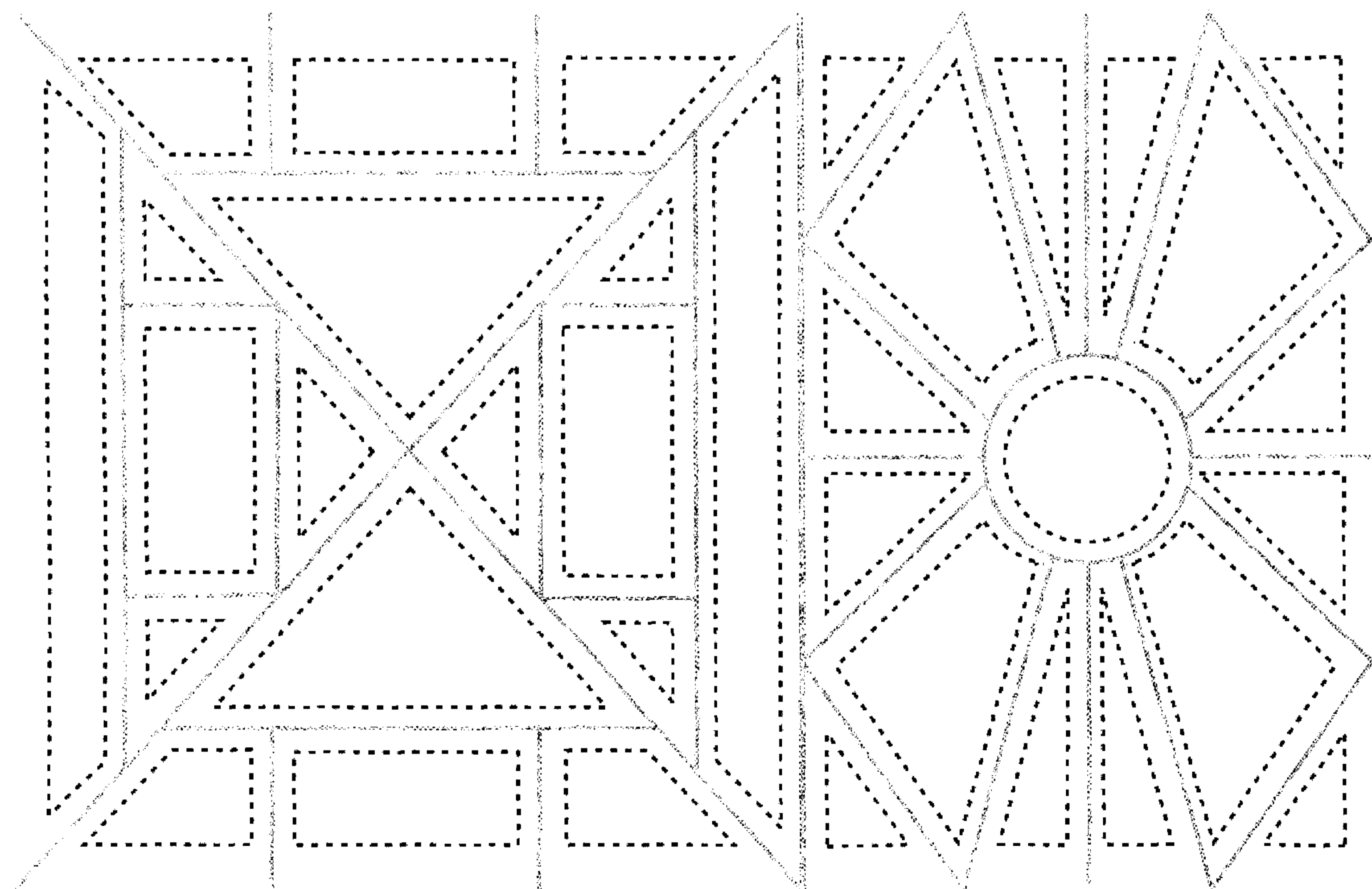
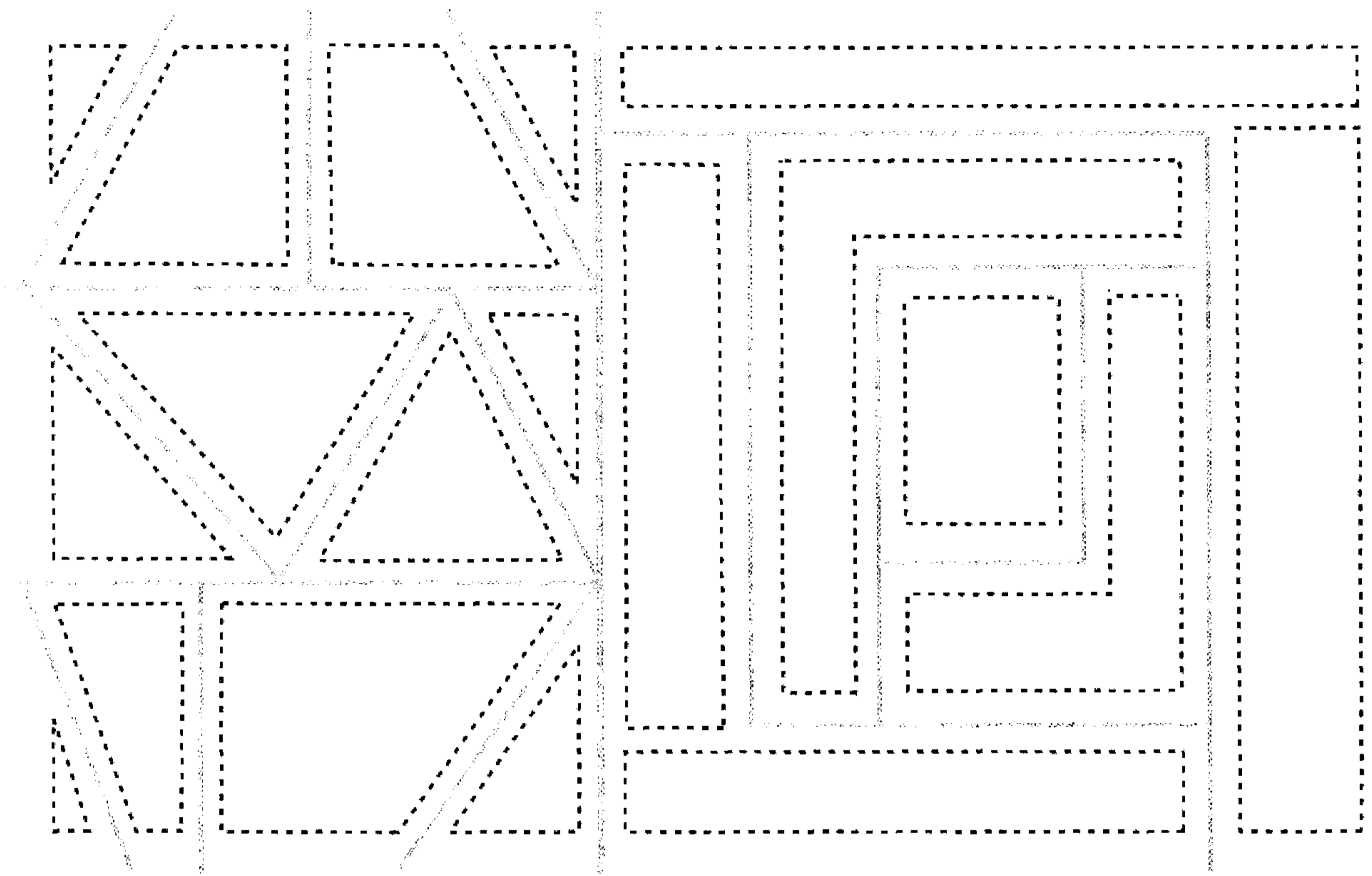

Ё

Ёж

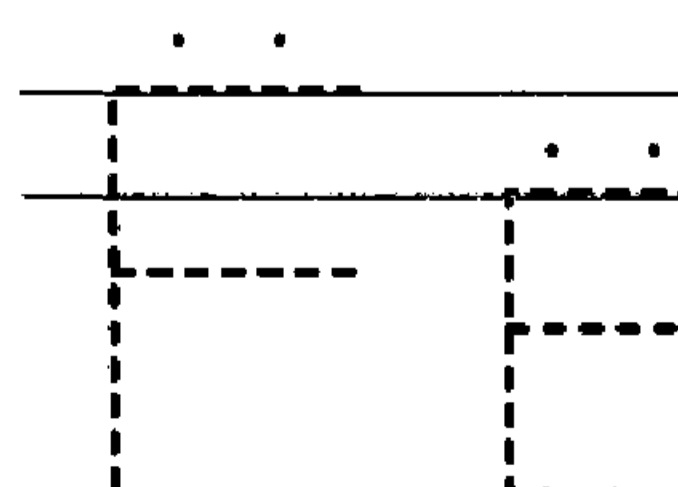
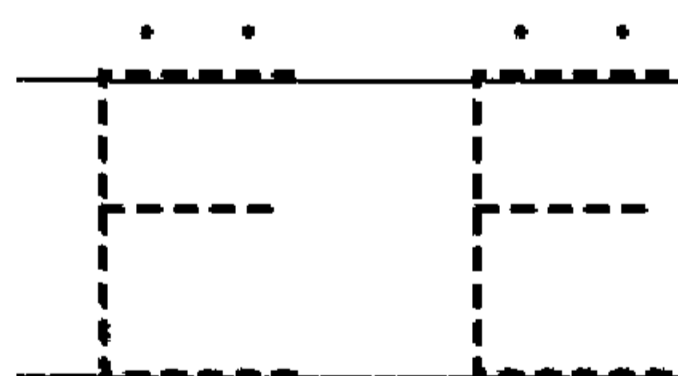
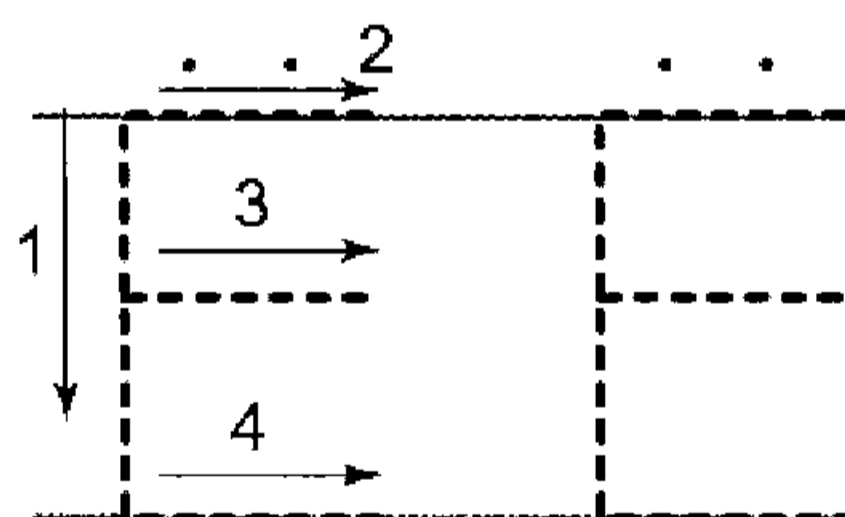

Проведи линию посередине дорожки, не отрывая карандаш от бумаги и не выходя за края дорожки. Раскрась дорожку.

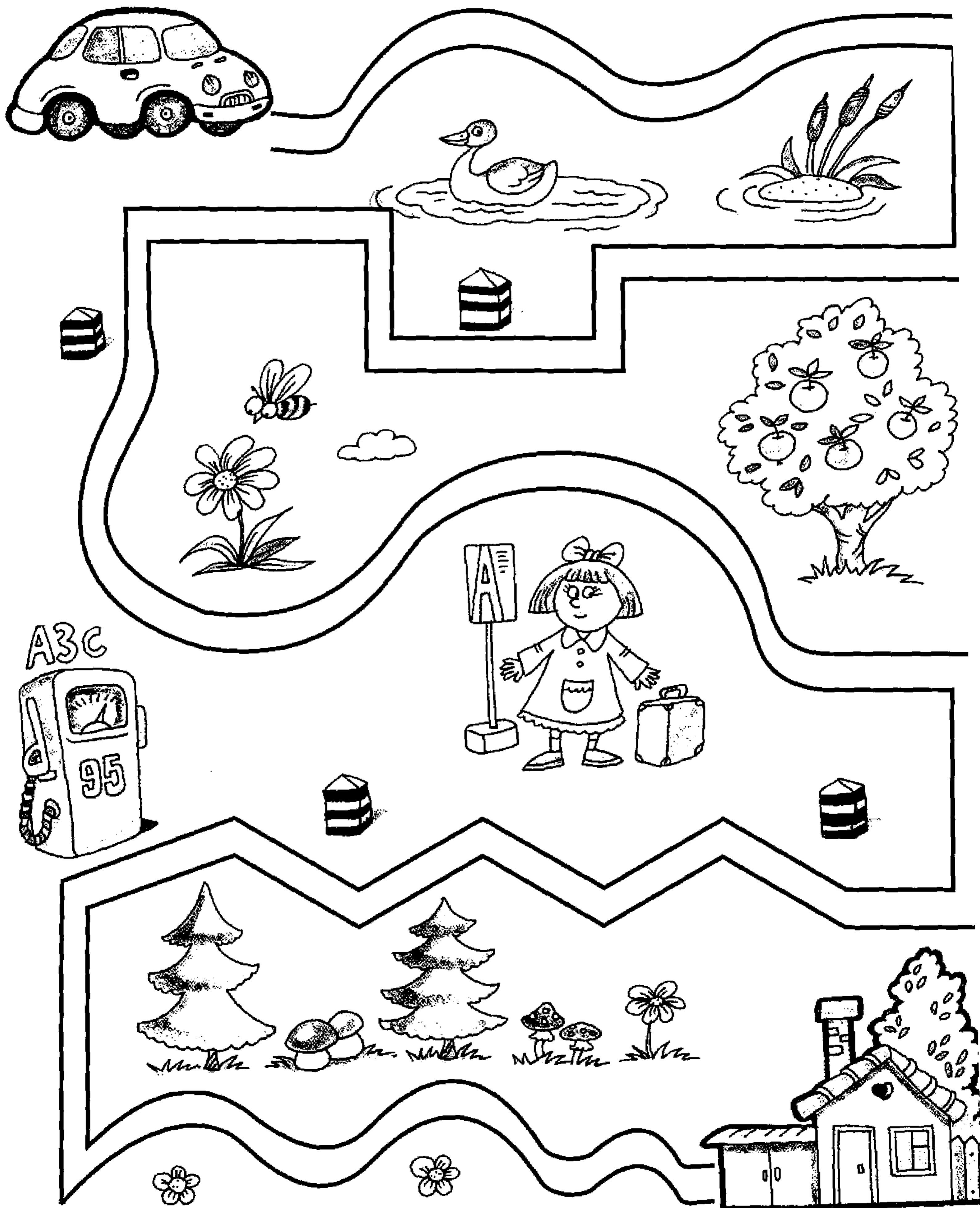

ЖЖ

Жираф

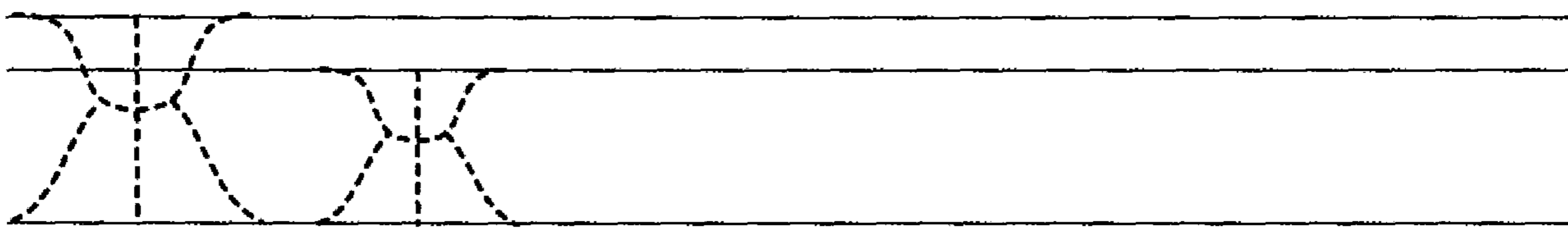
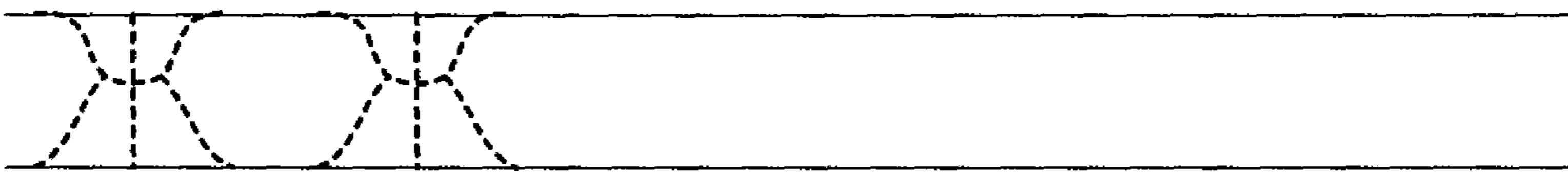
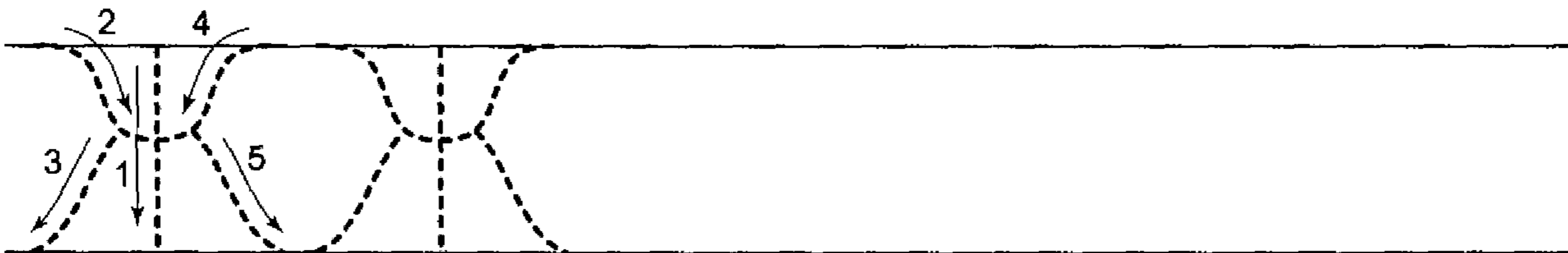
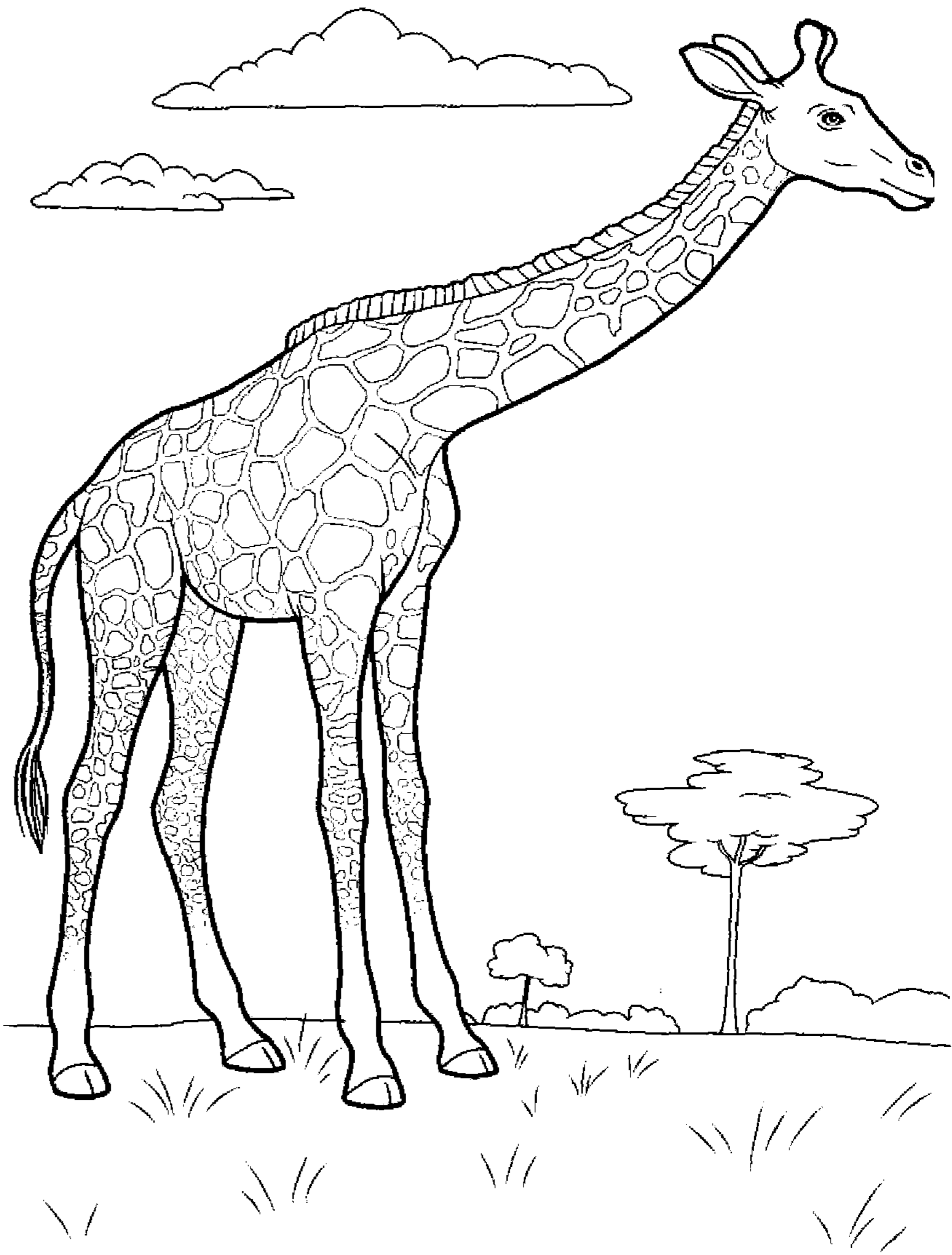

.....
Дорисуй картинку. Соедини линии по точкам и раскрась.
.....

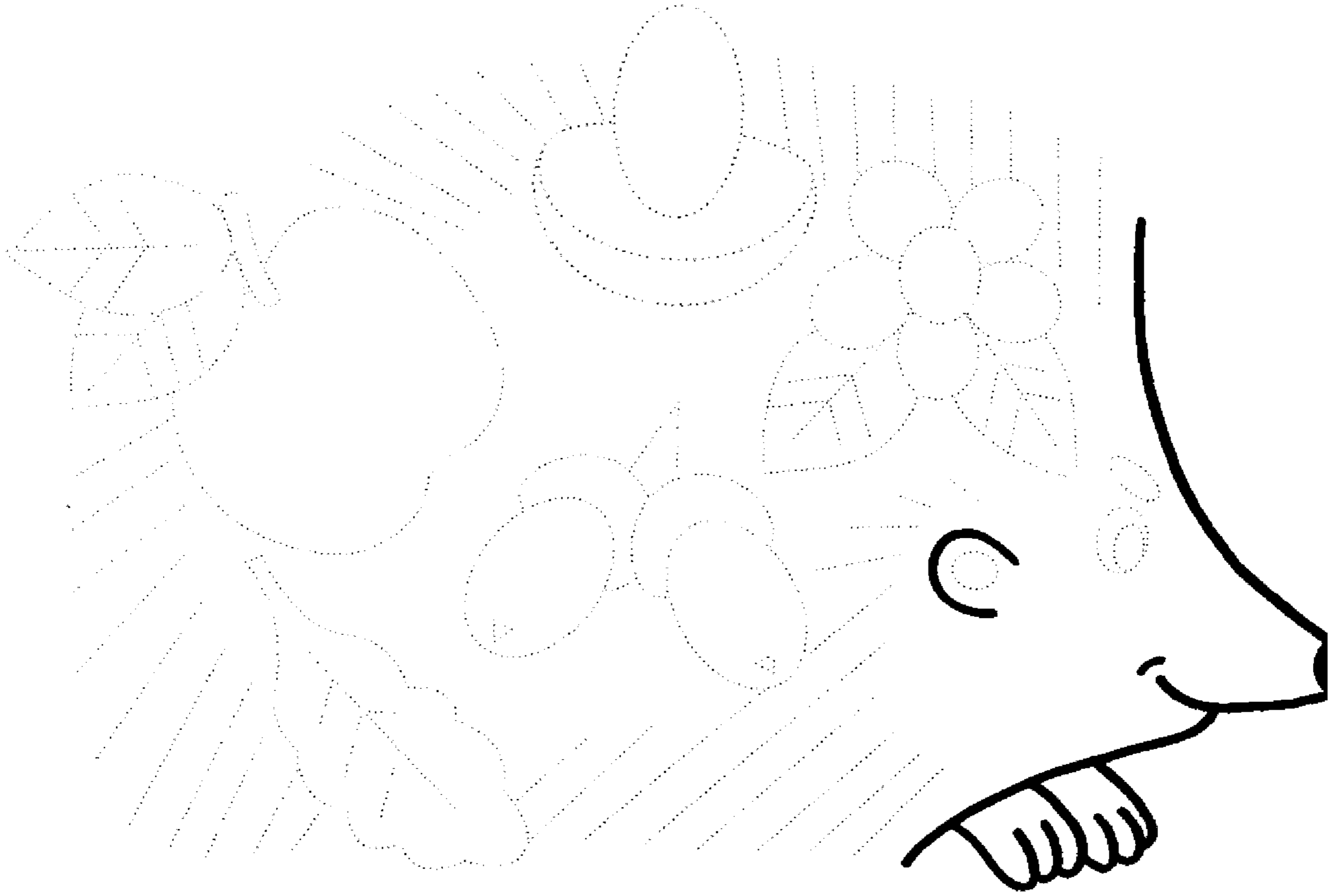

.....
Выполни штриховку прямыми линиями, не выходя за контур рисунка, и раскрась.
.....

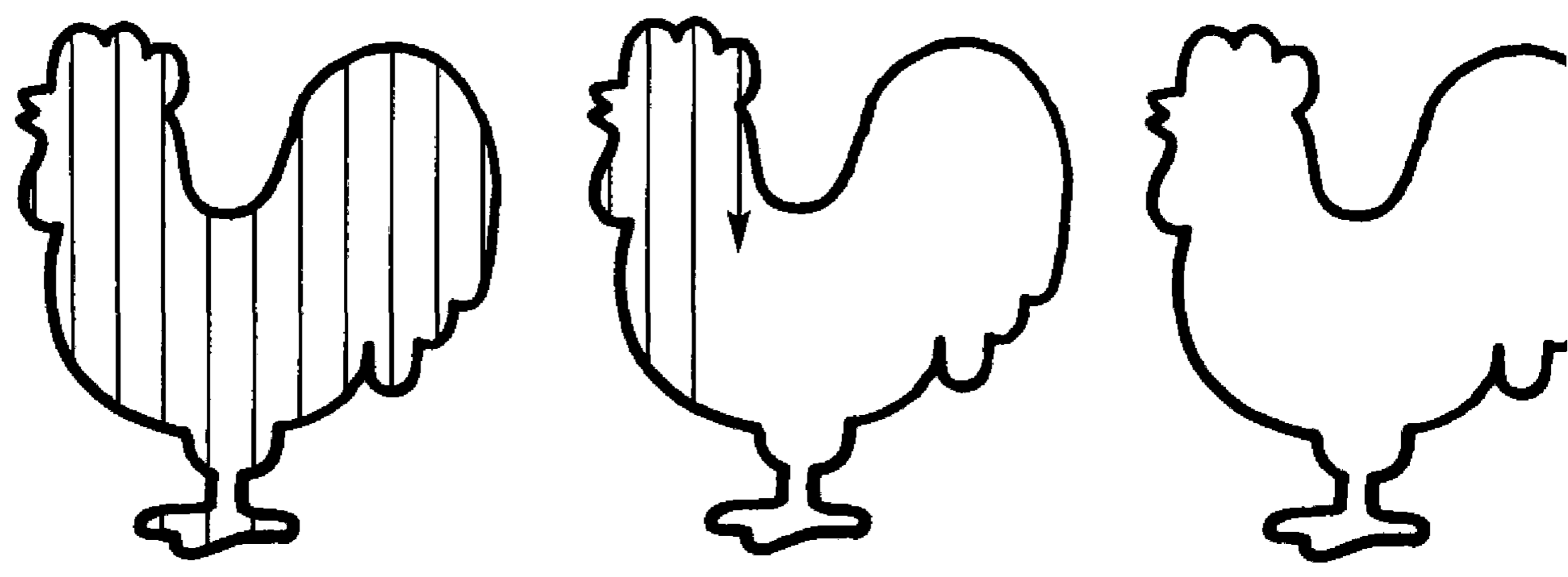

З

Заяц

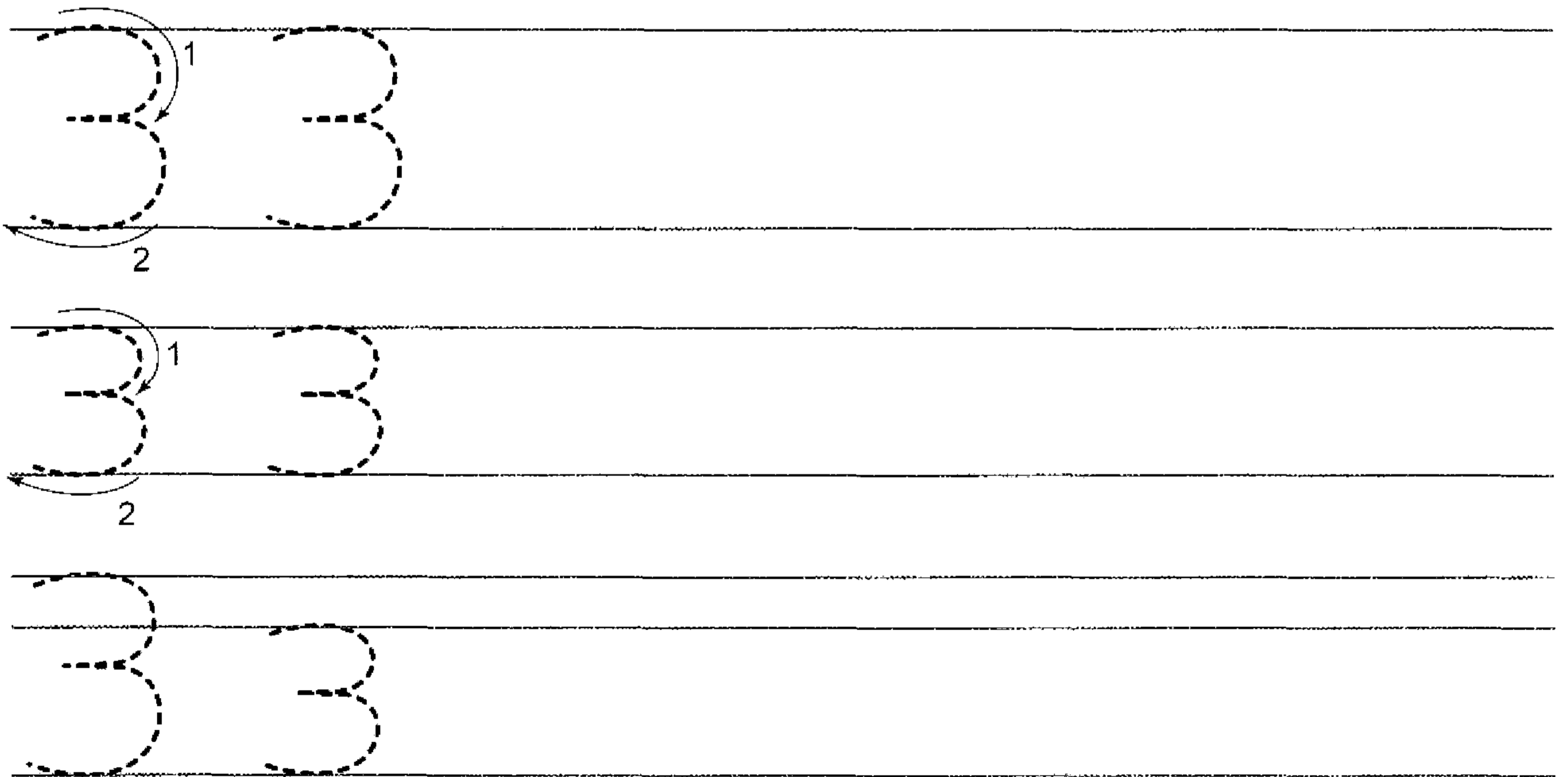
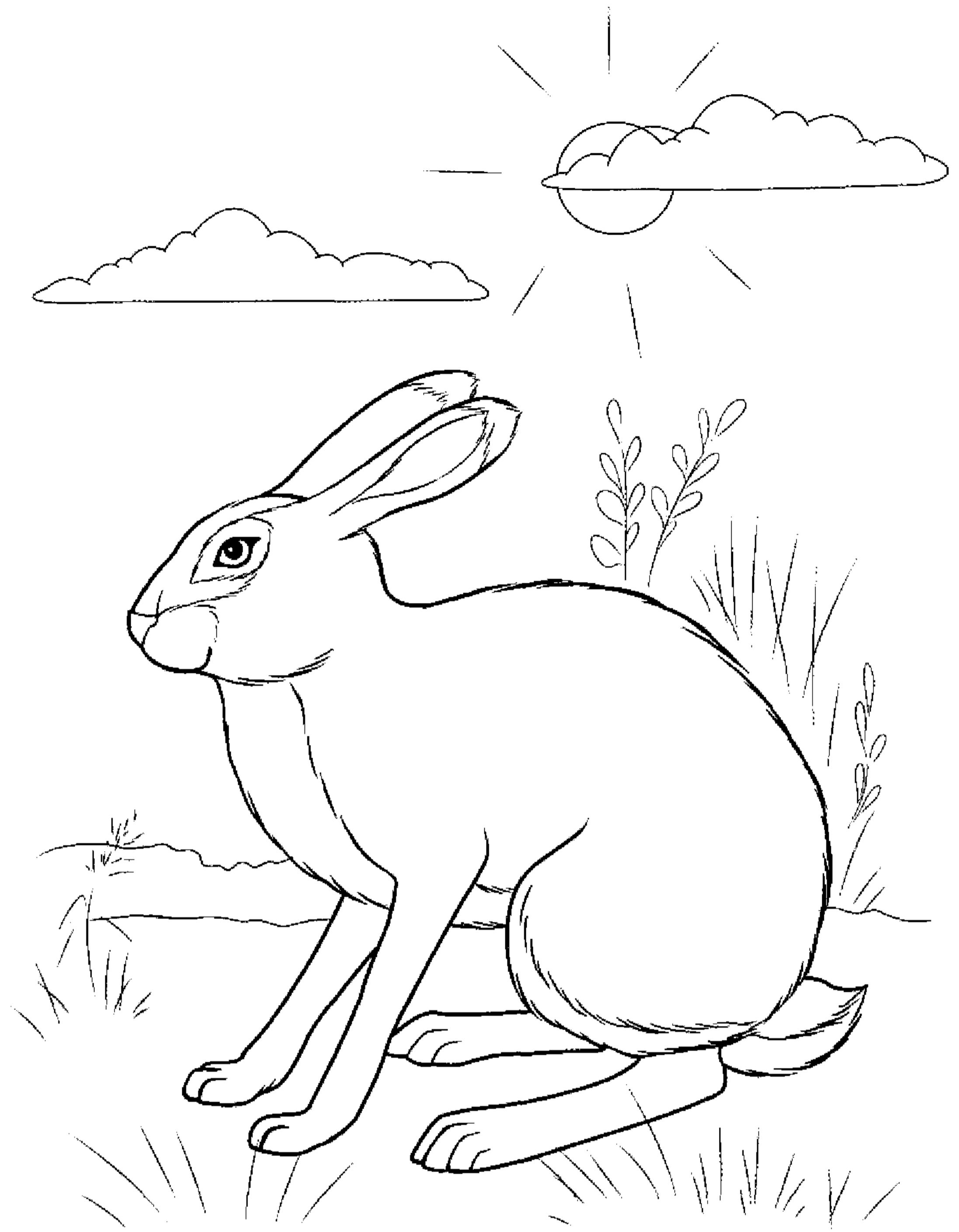

Обведи картинки по пунктирным линиям и раскрась их.

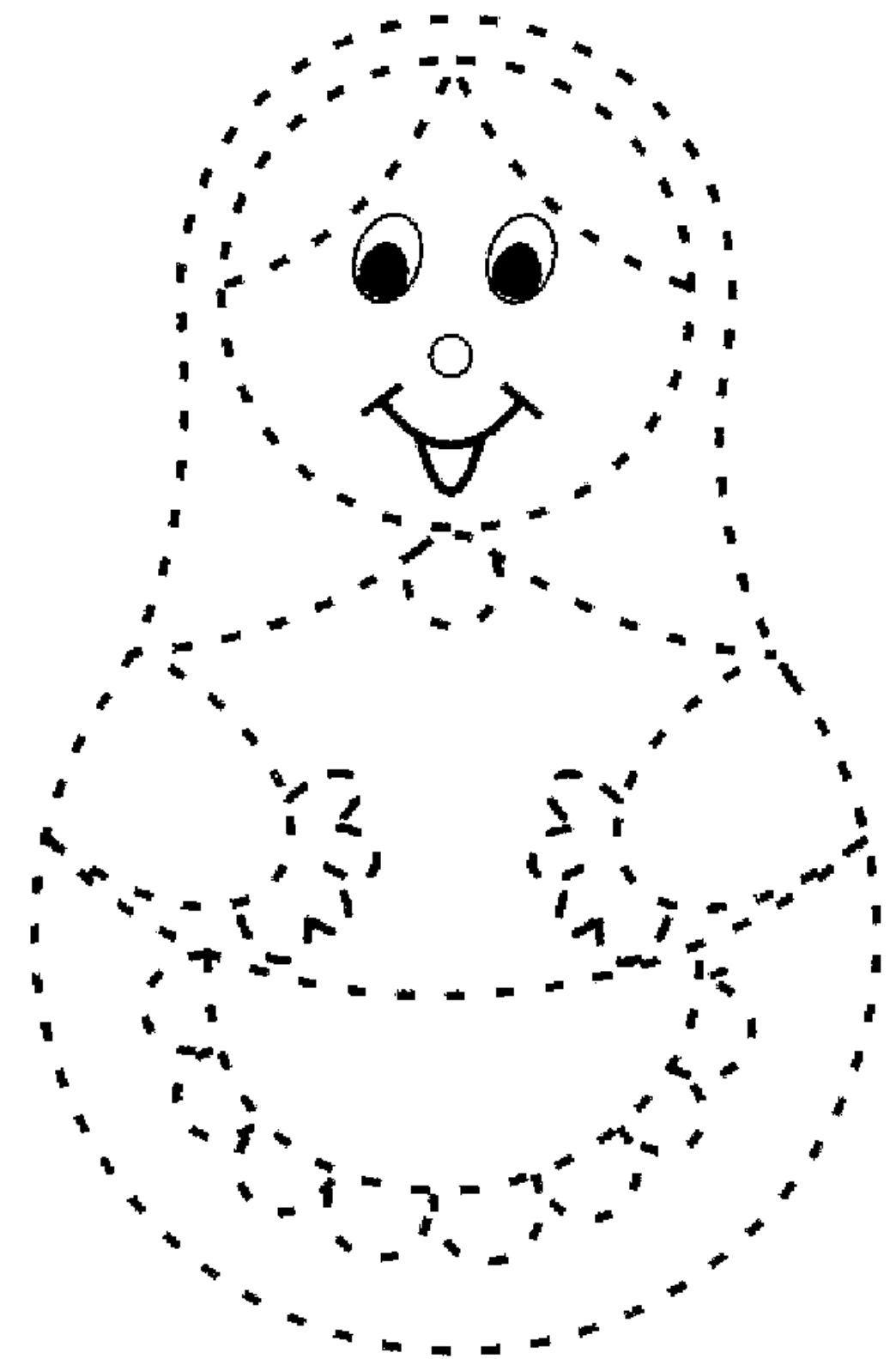
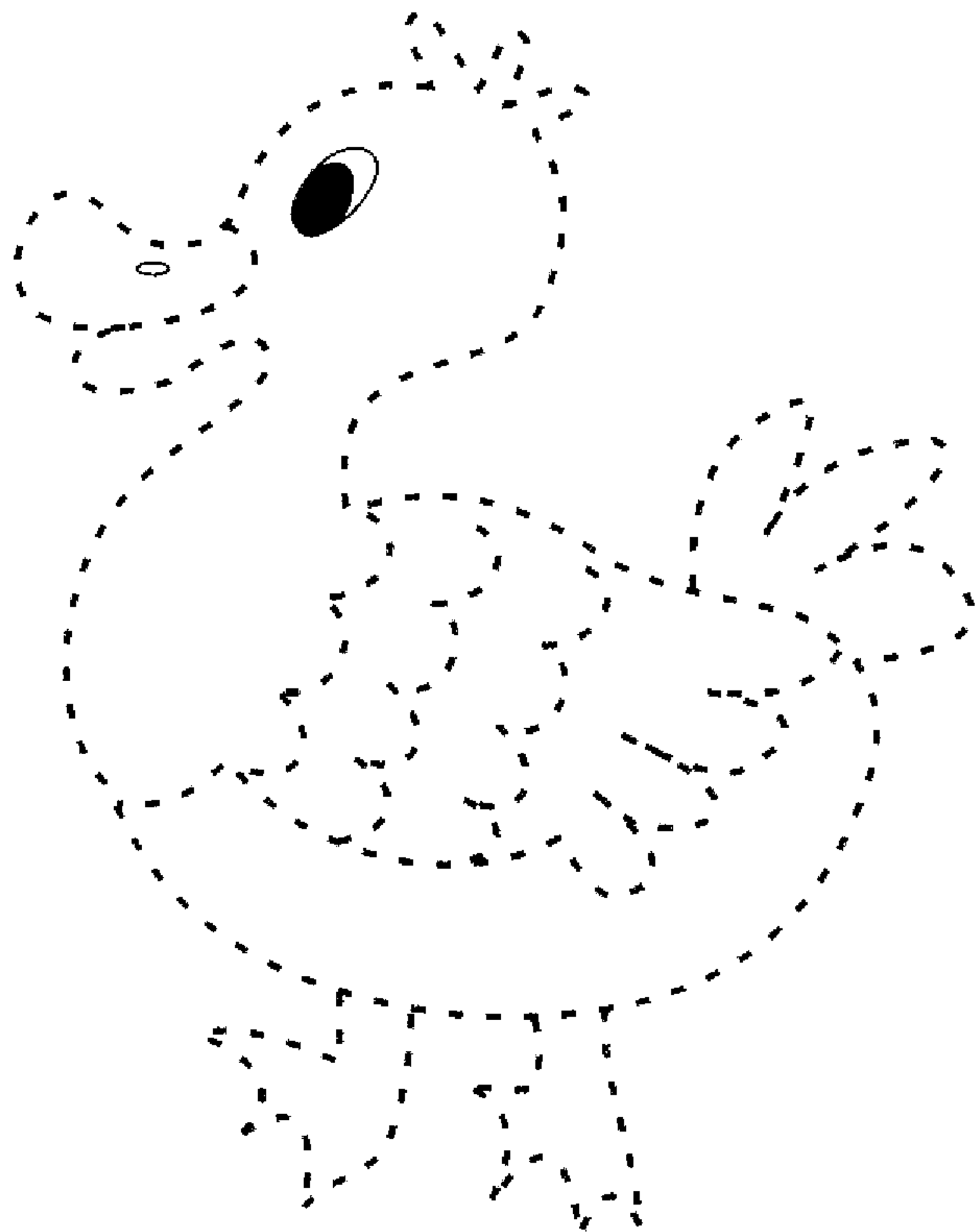
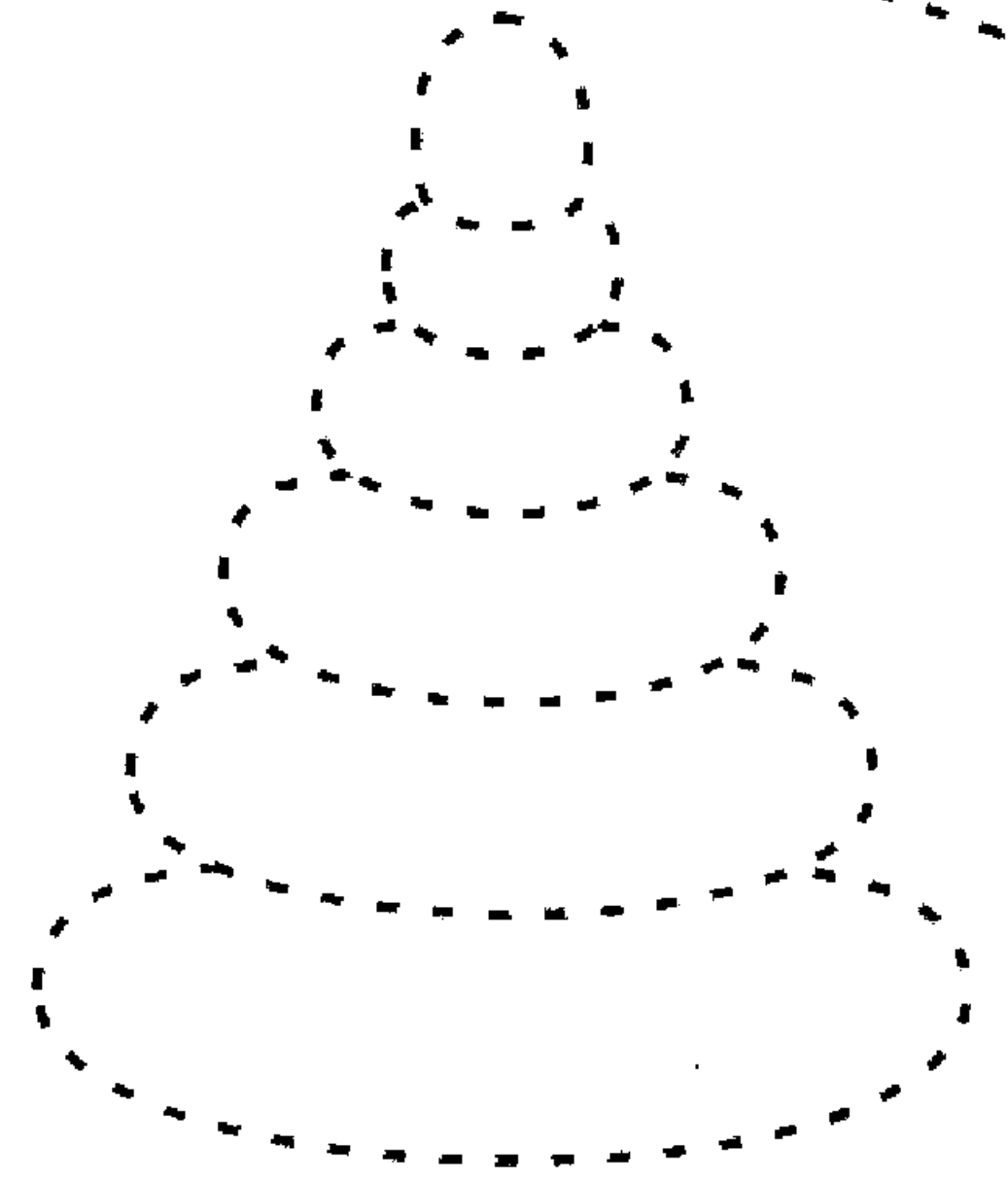
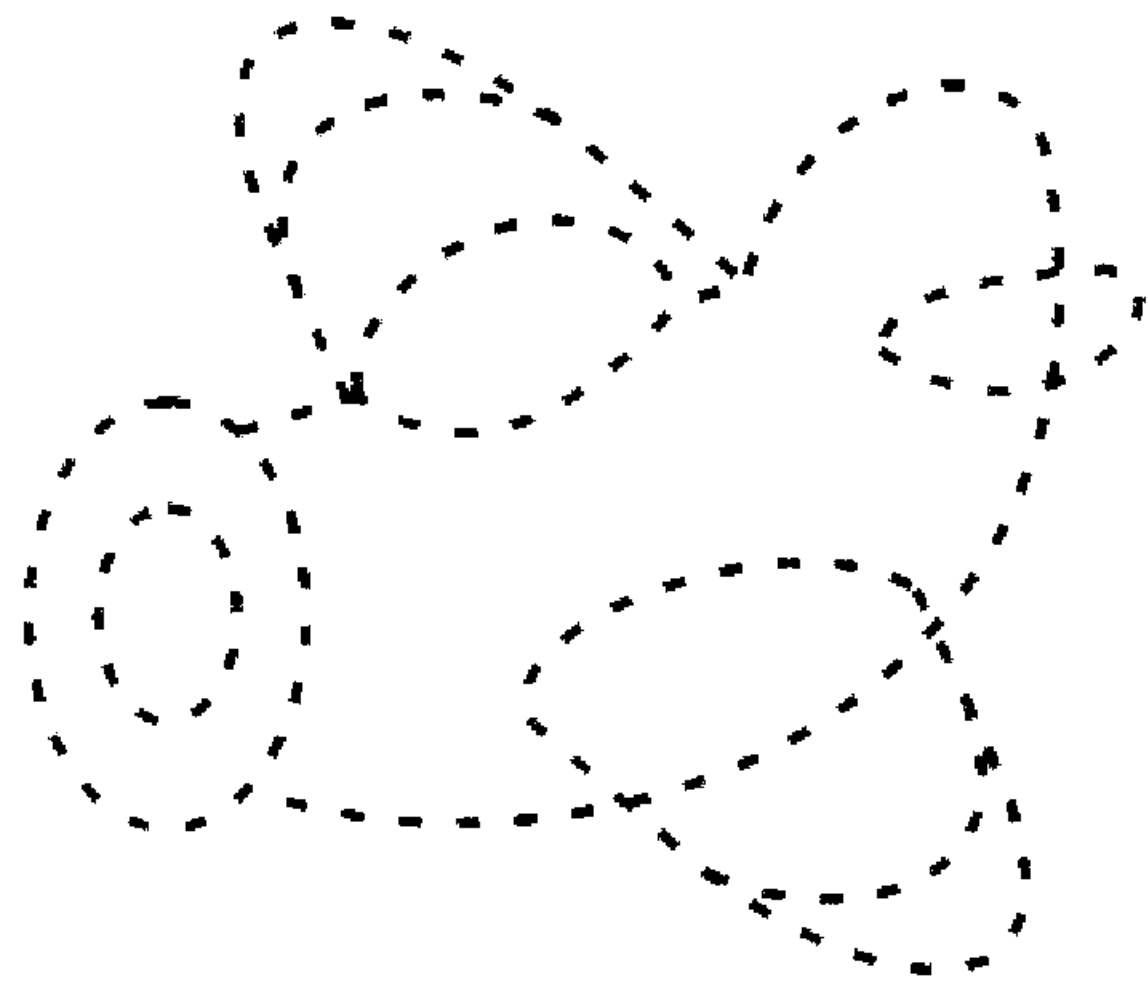
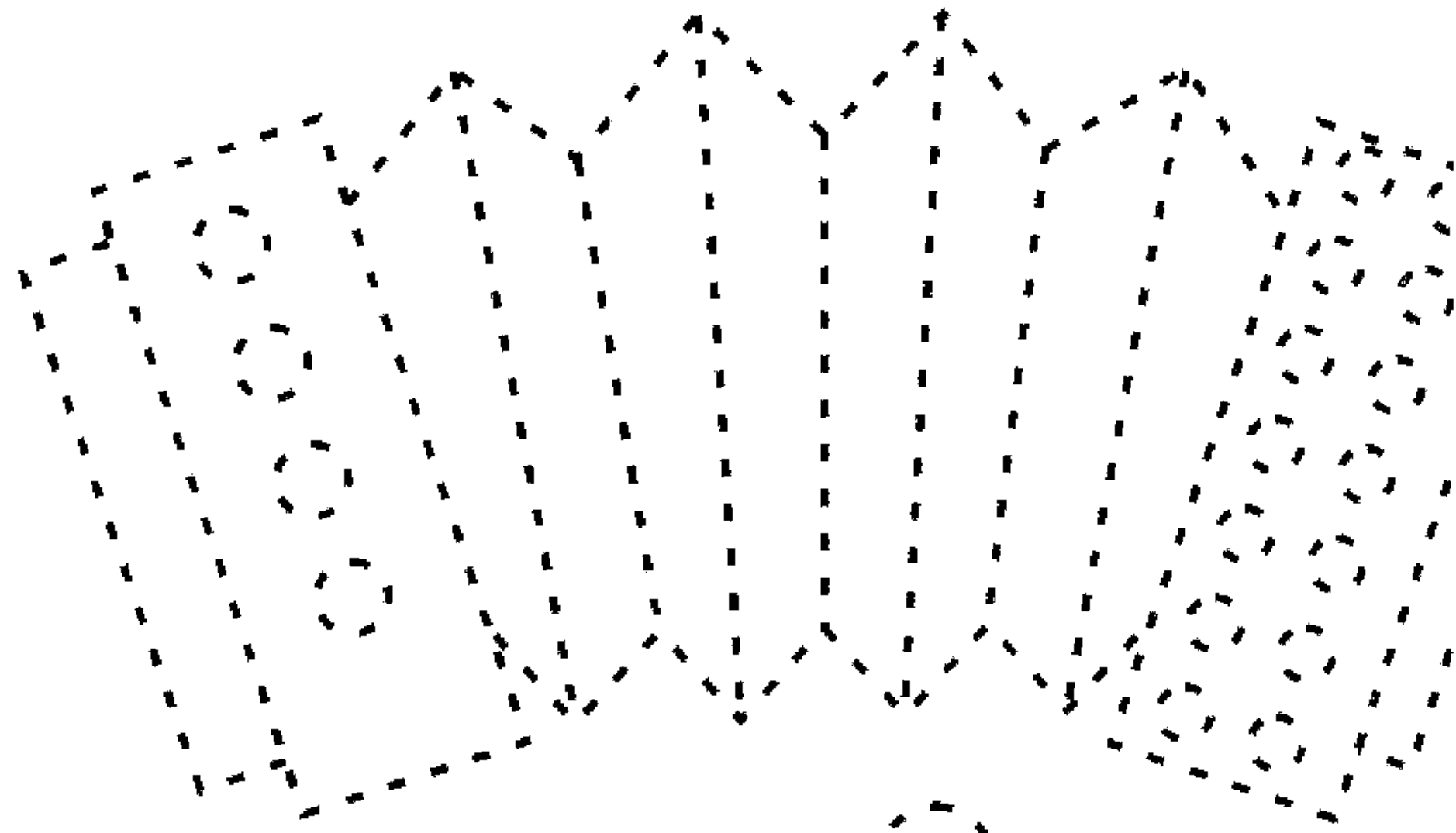
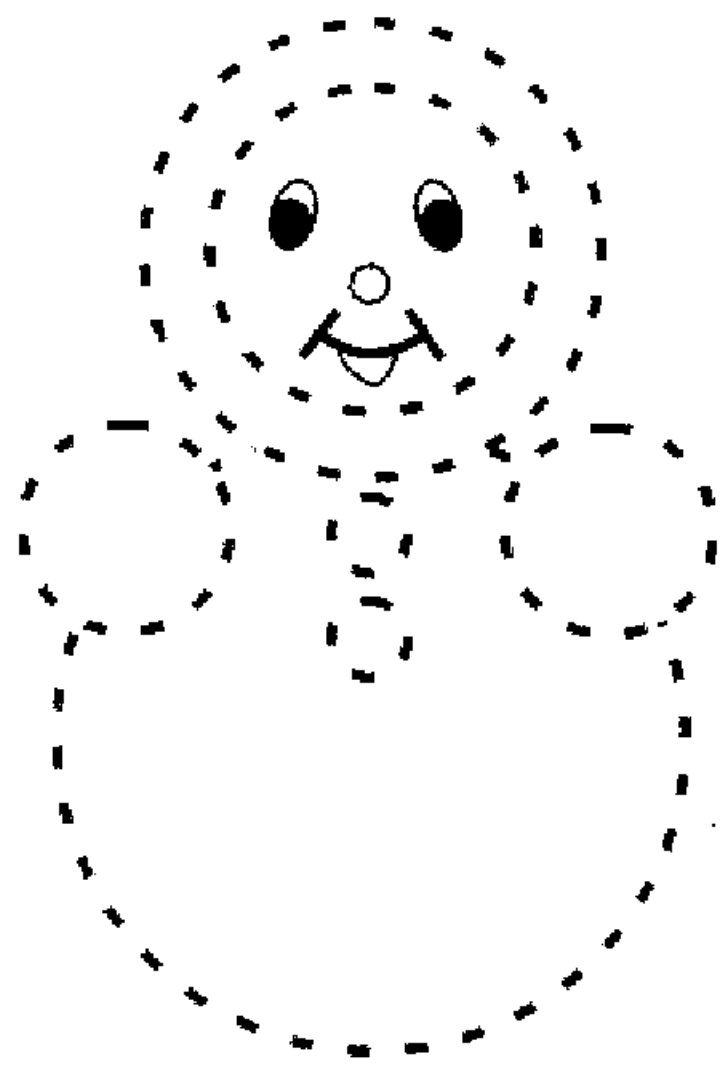

И

Индюк

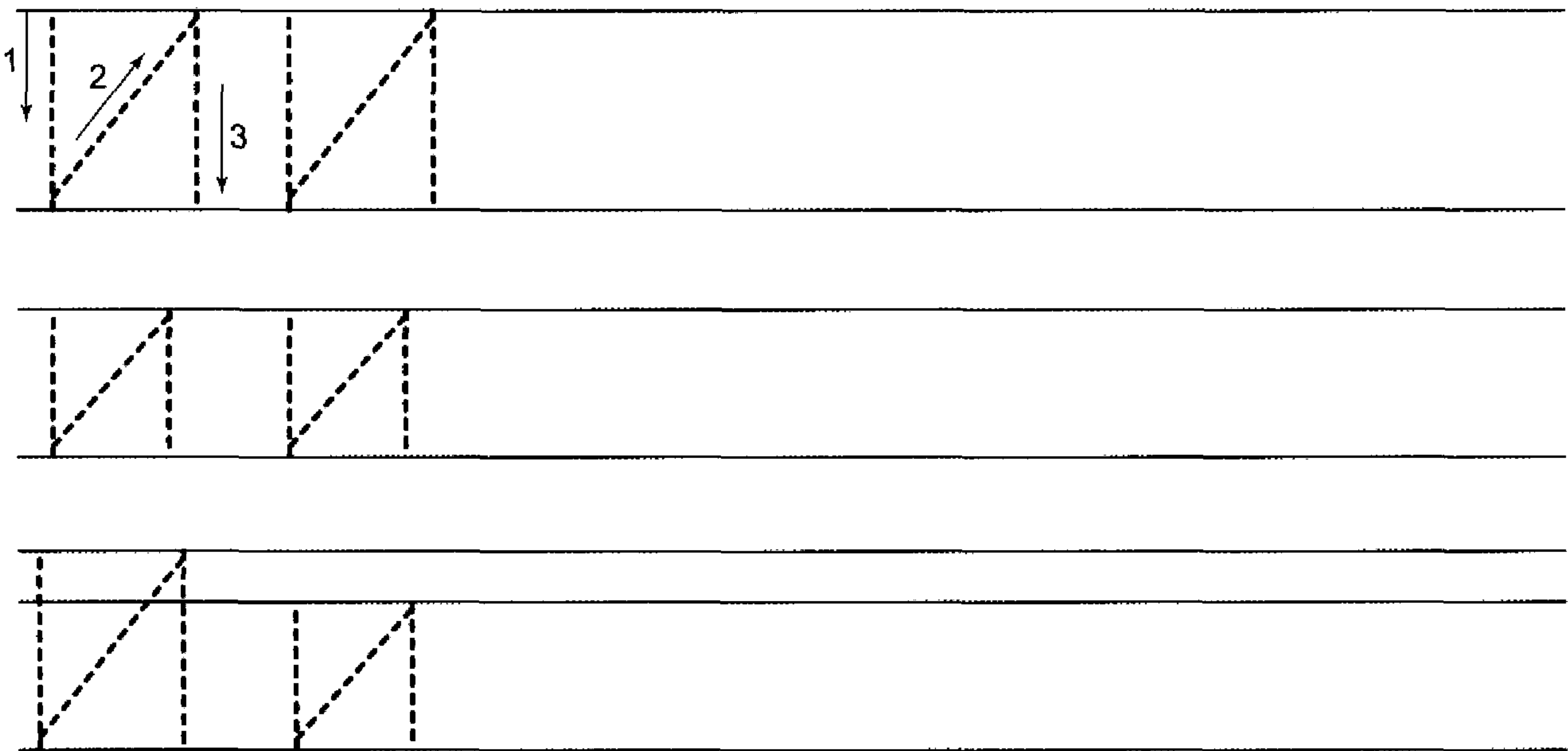
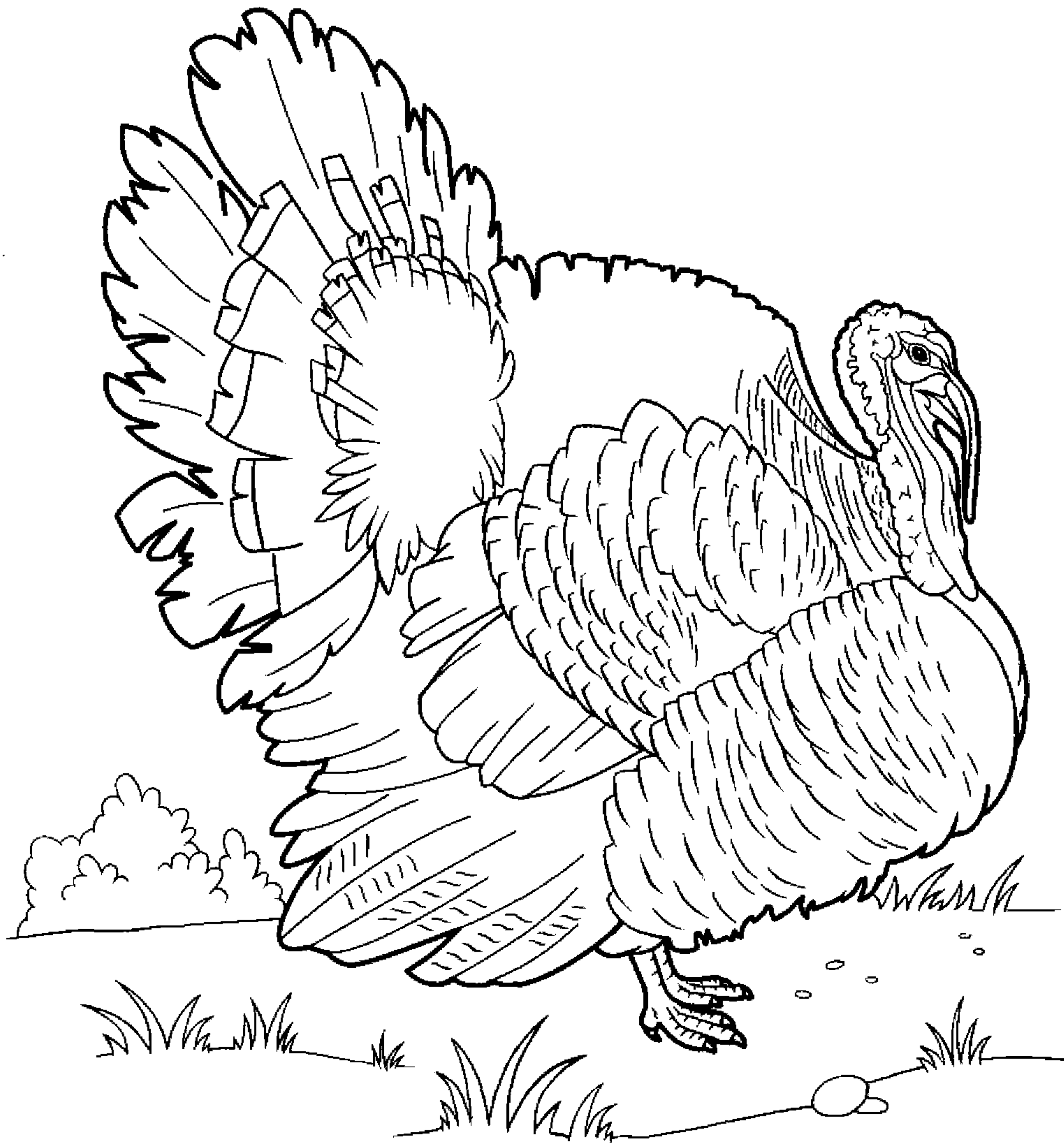

Дорисуй по точкам и раскрась.

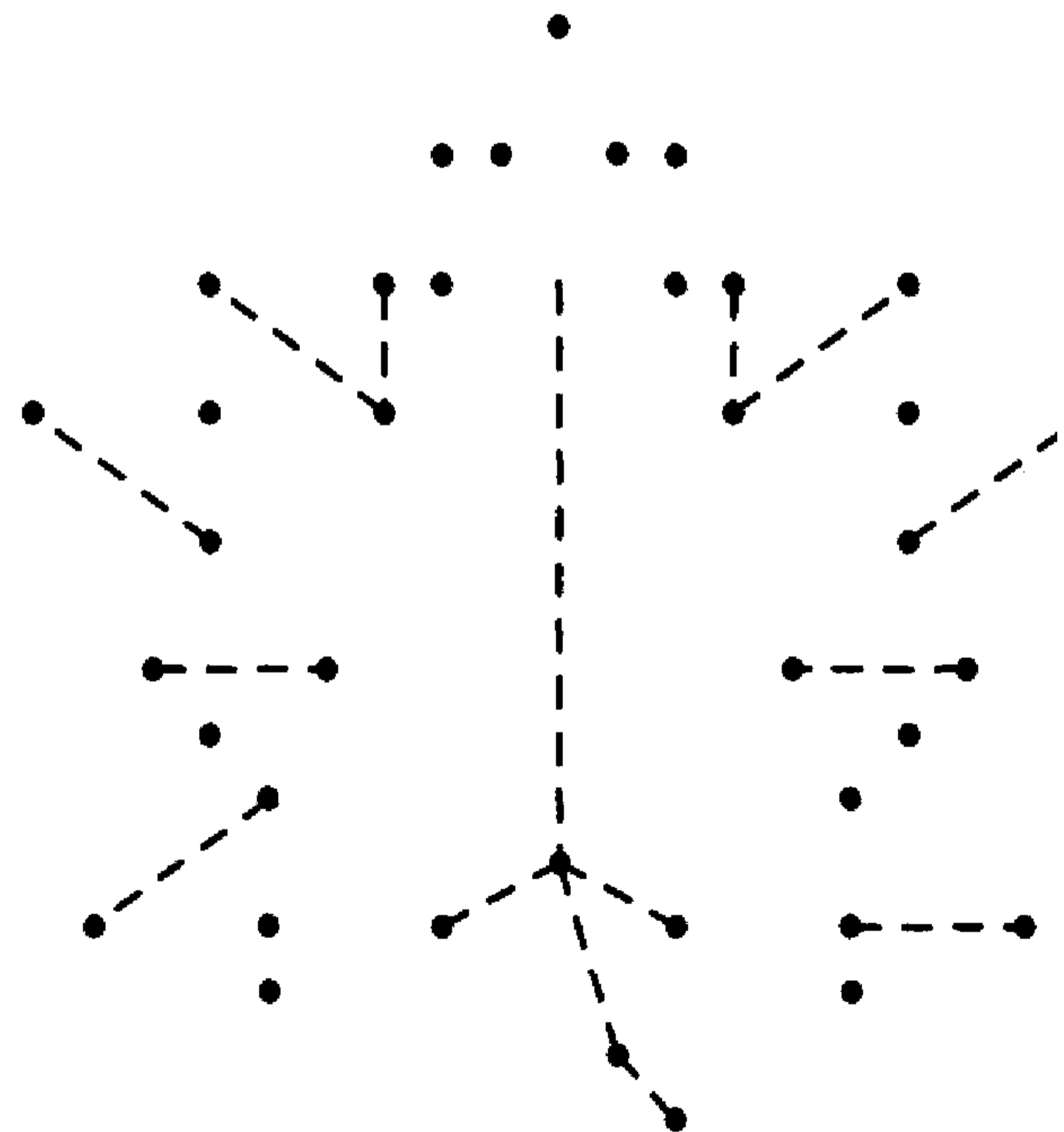
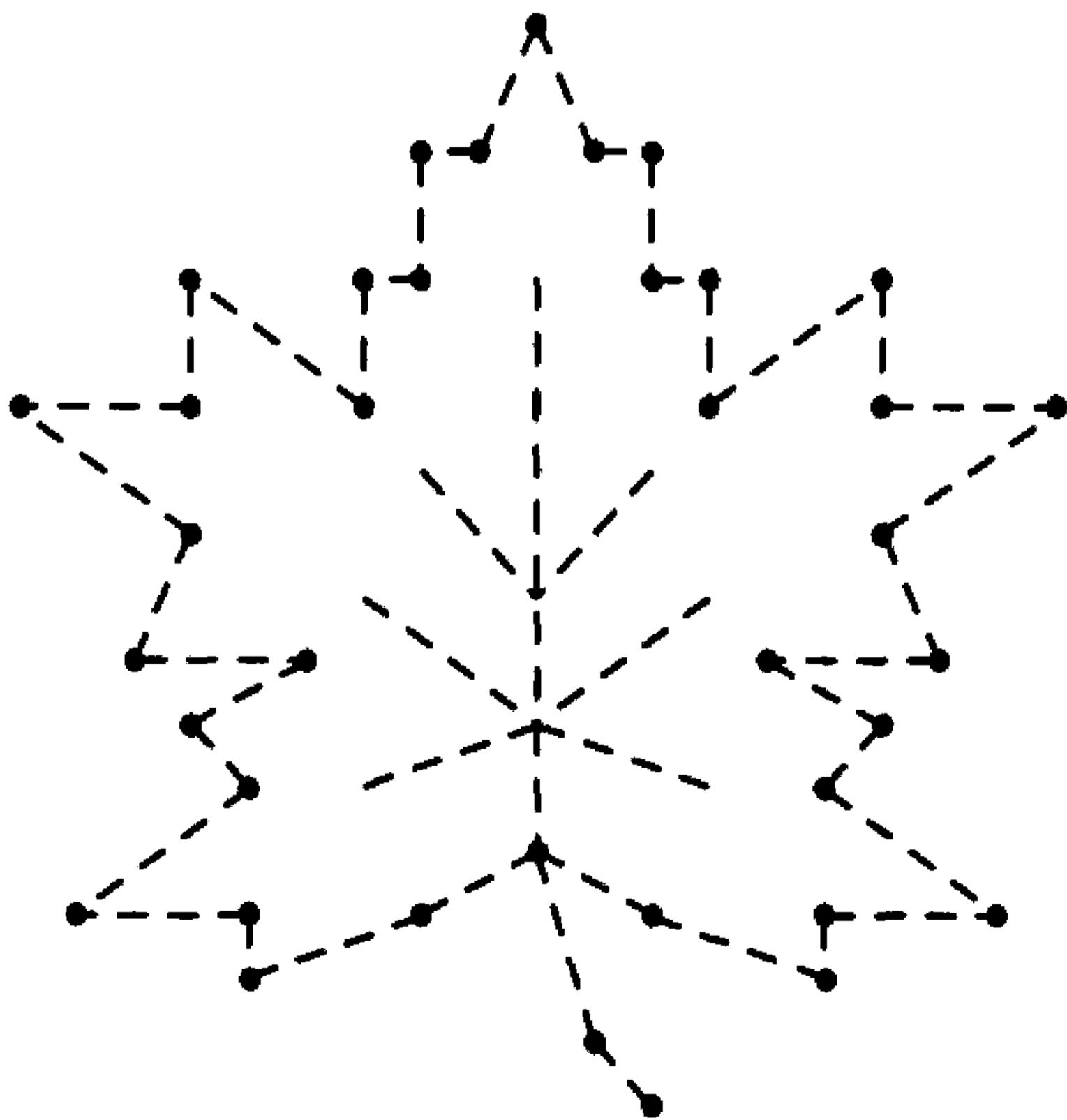
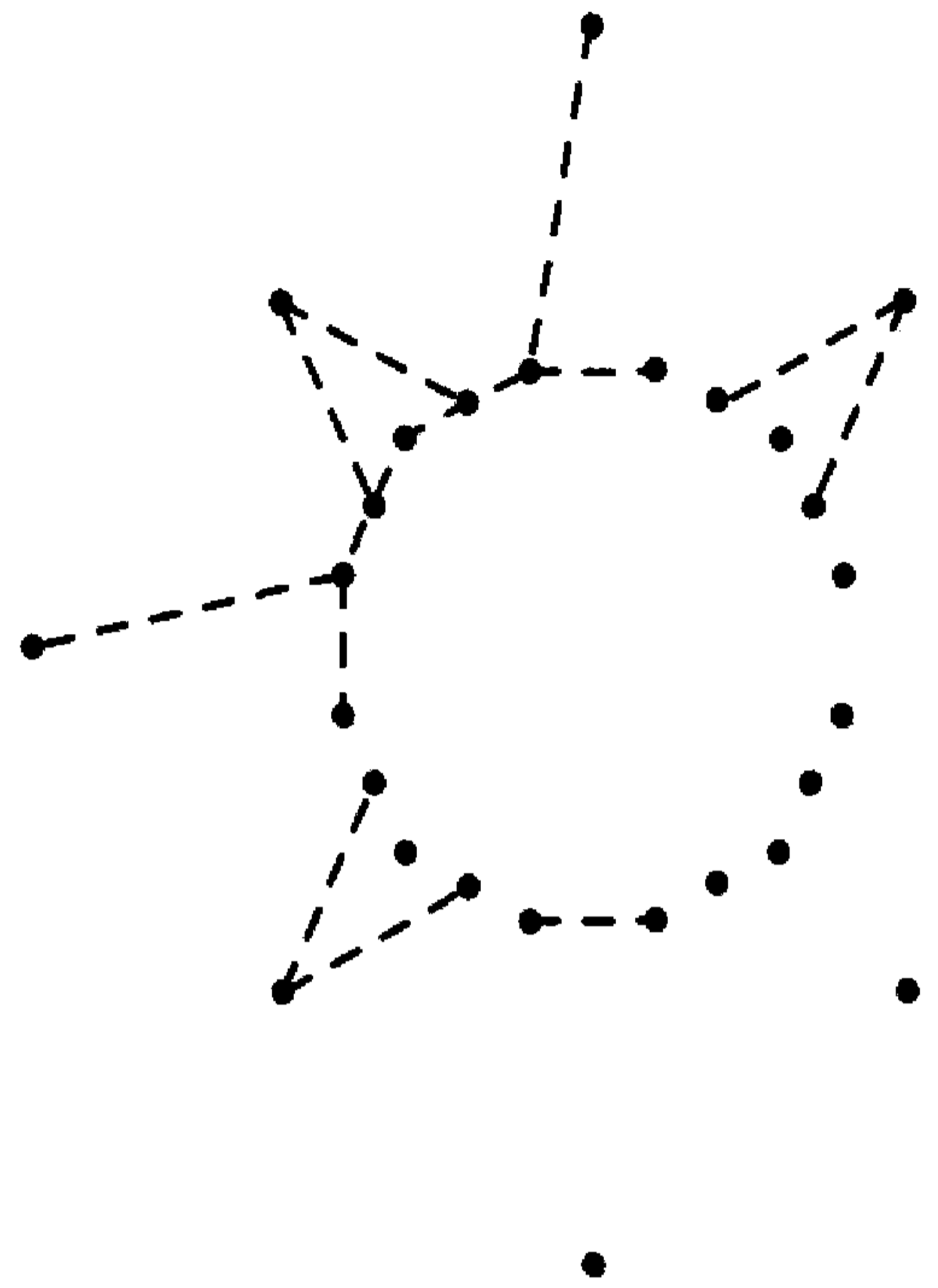
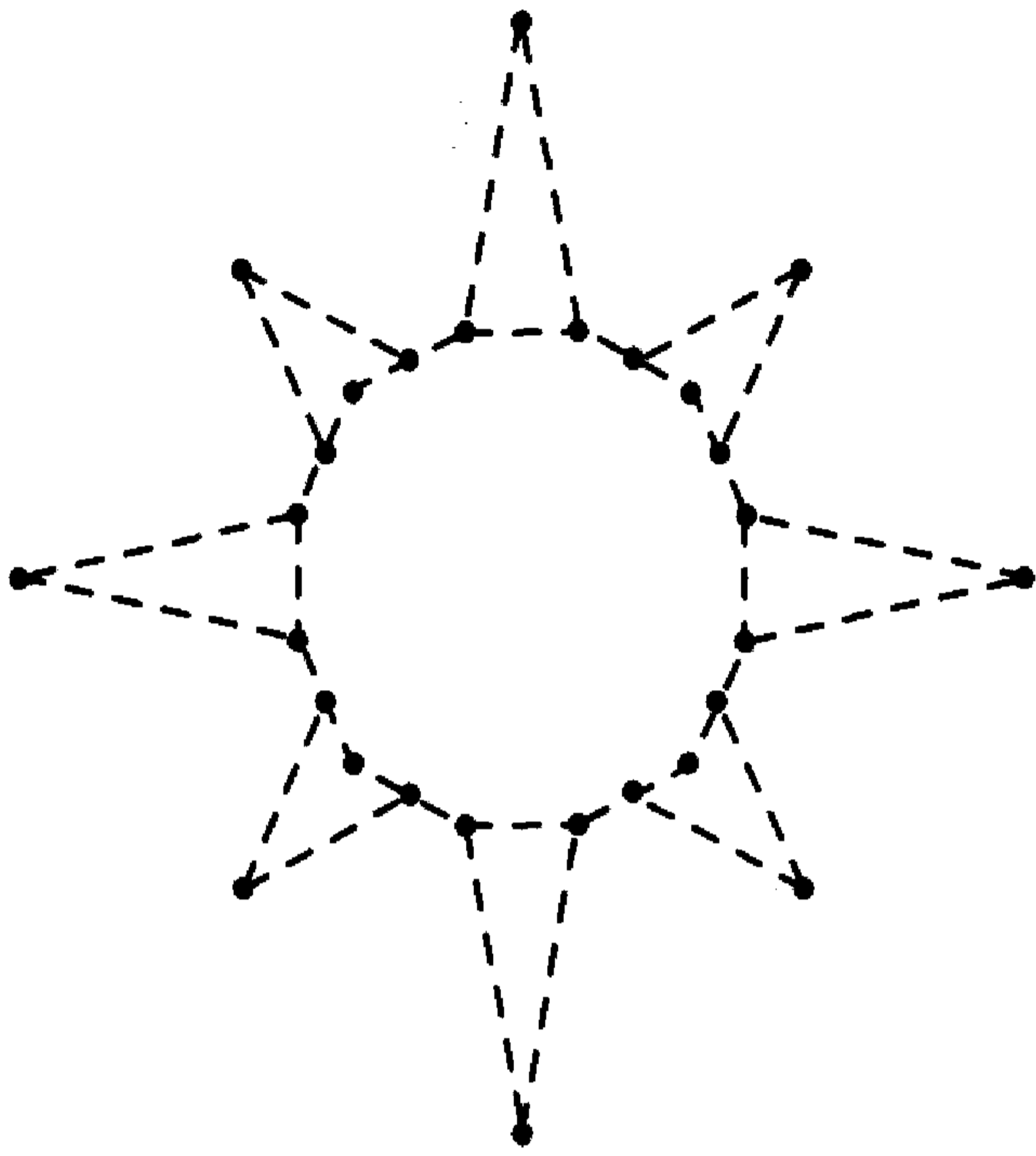

Й

Койот

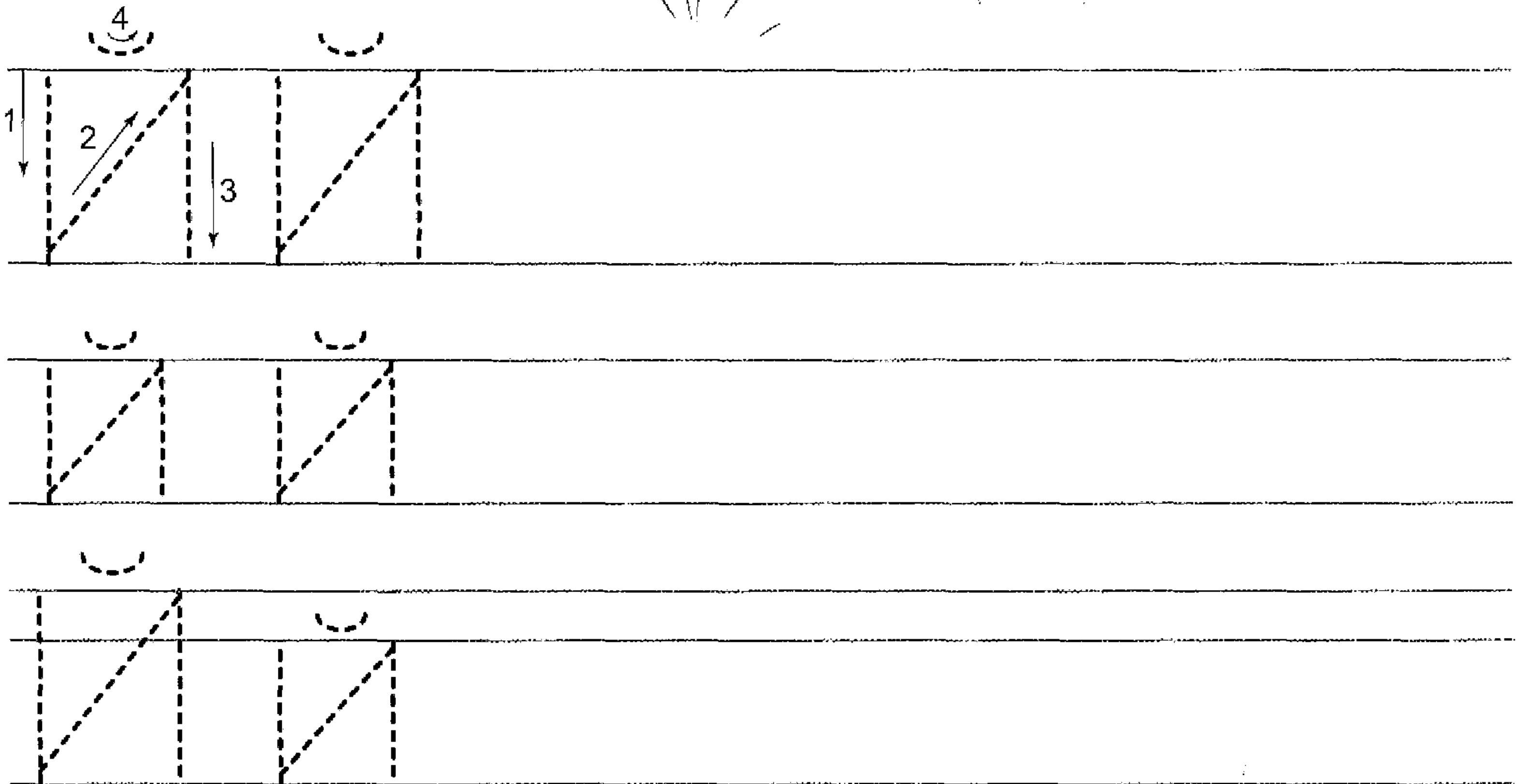
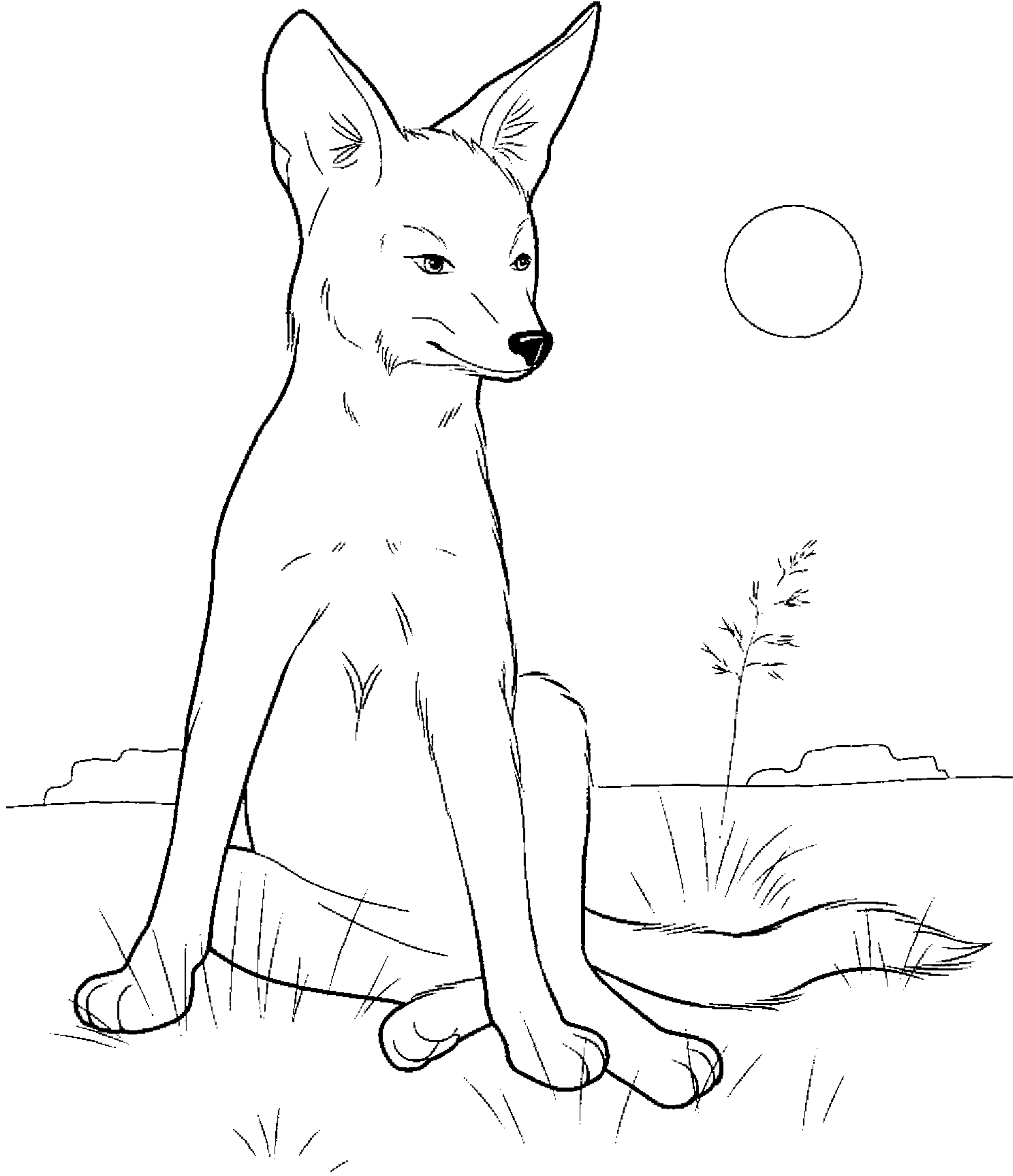

Обведи рисунки по пунктирным линиям и раскрась.

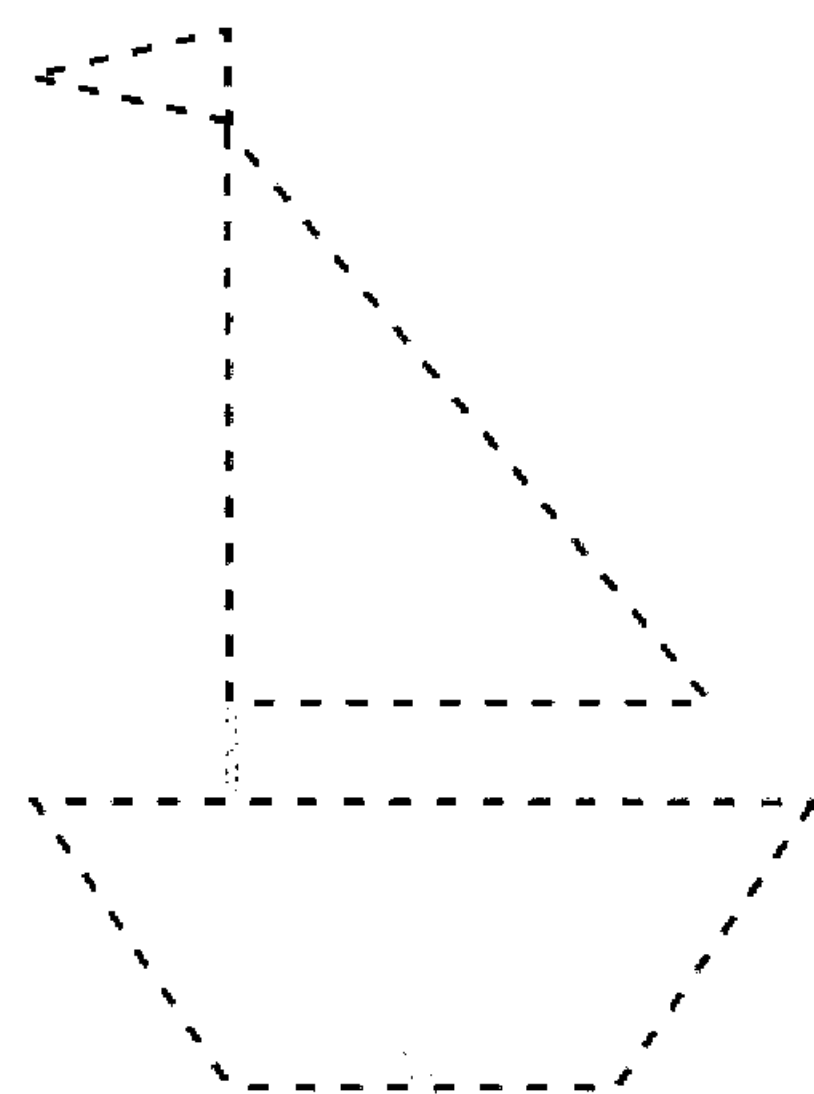
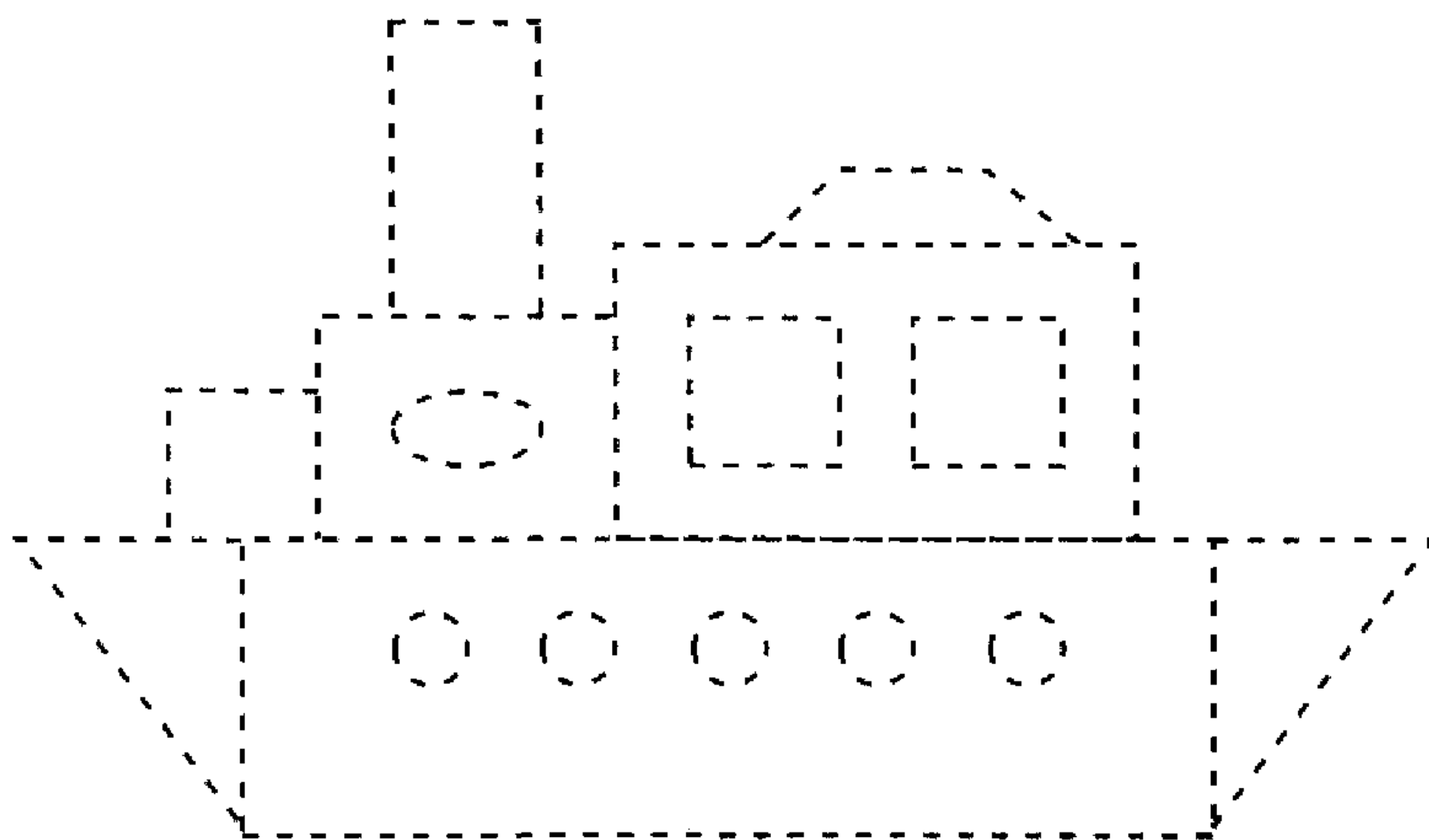
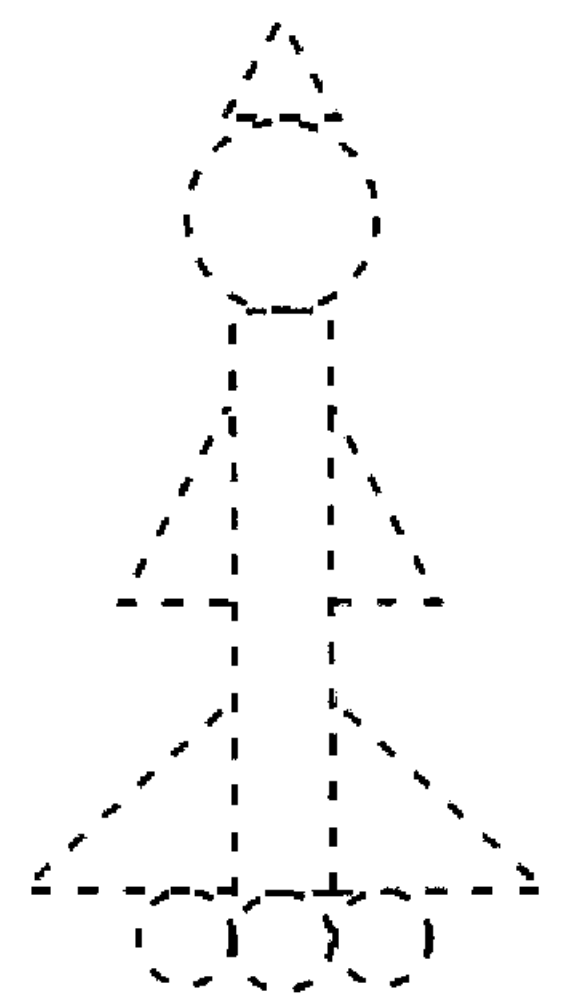
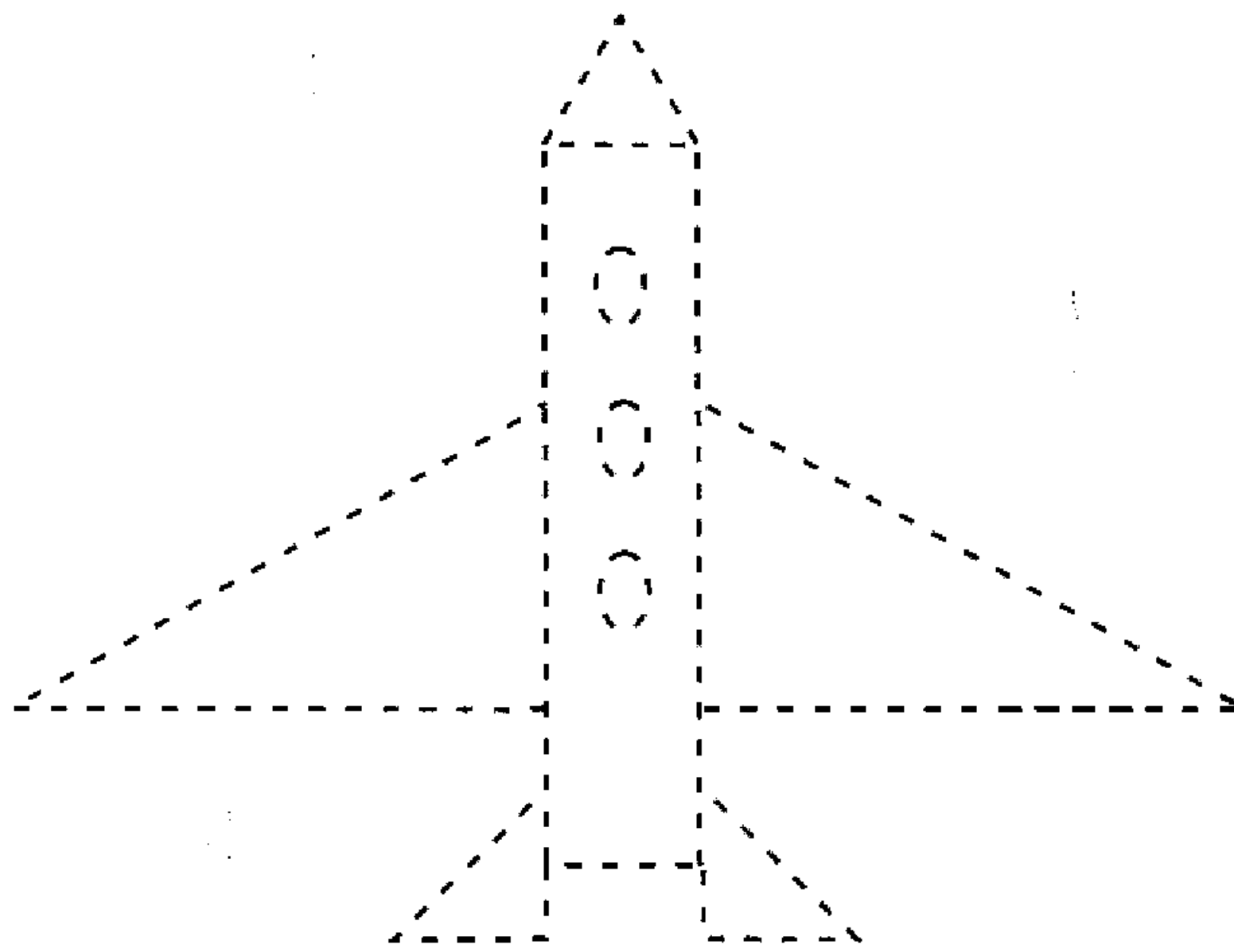
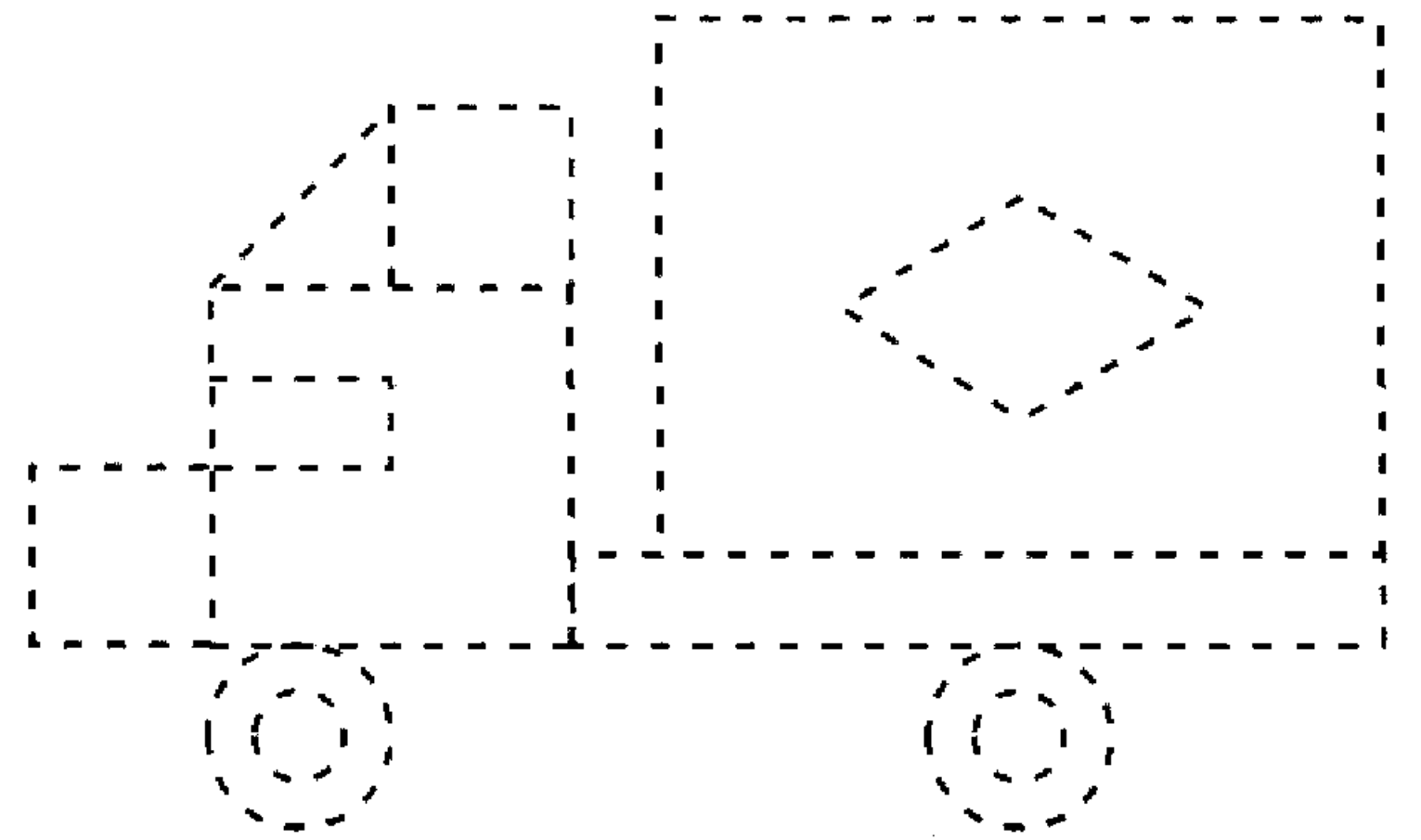
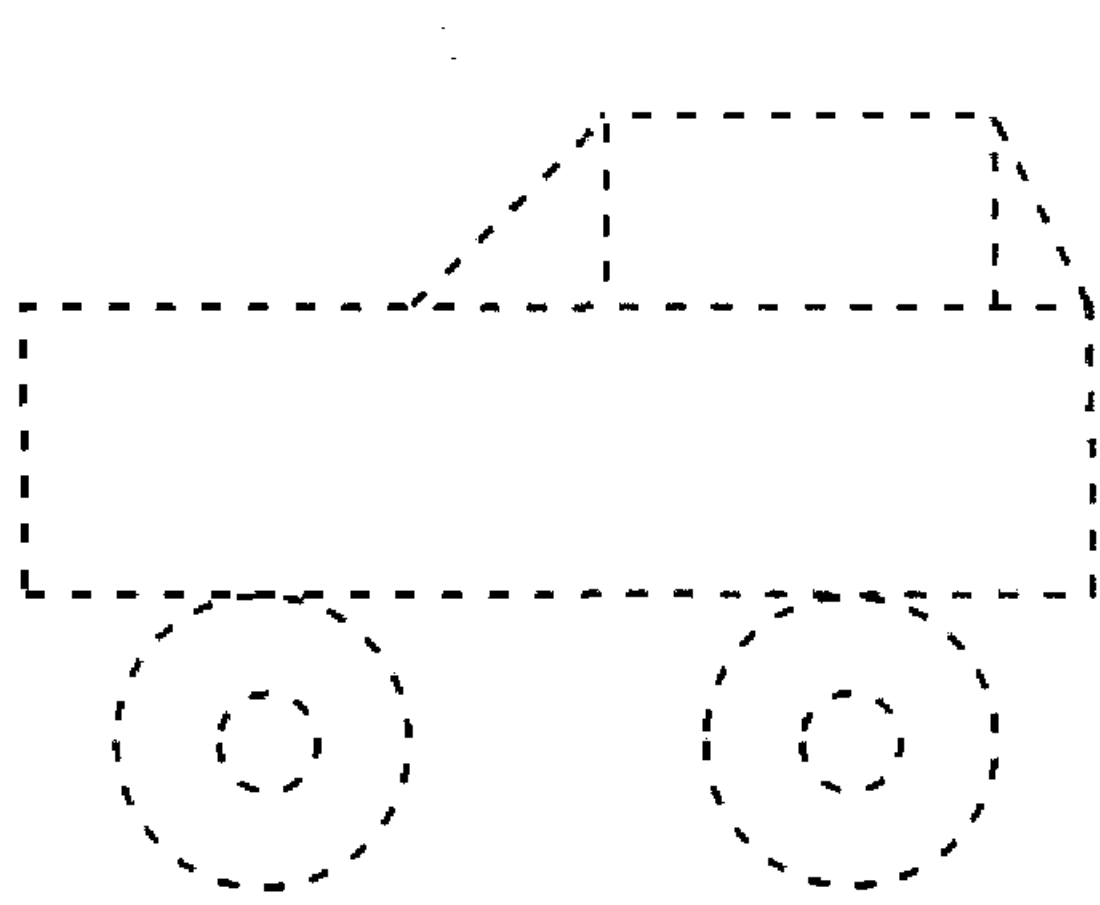

K

Коала

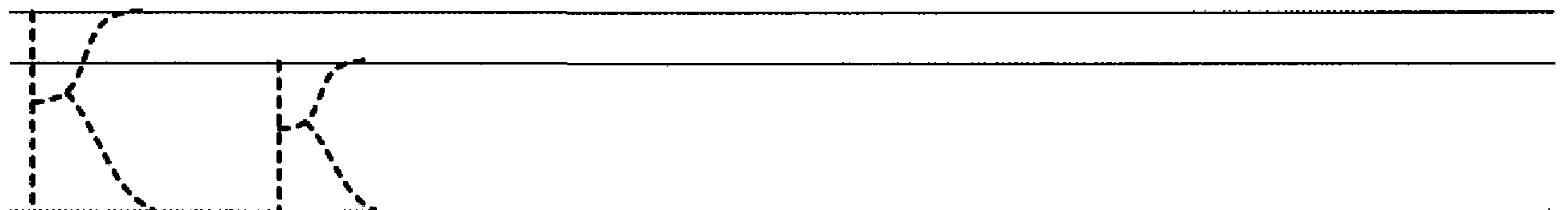
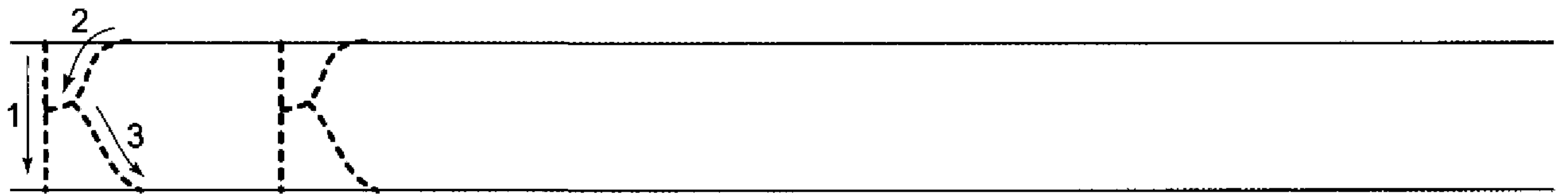
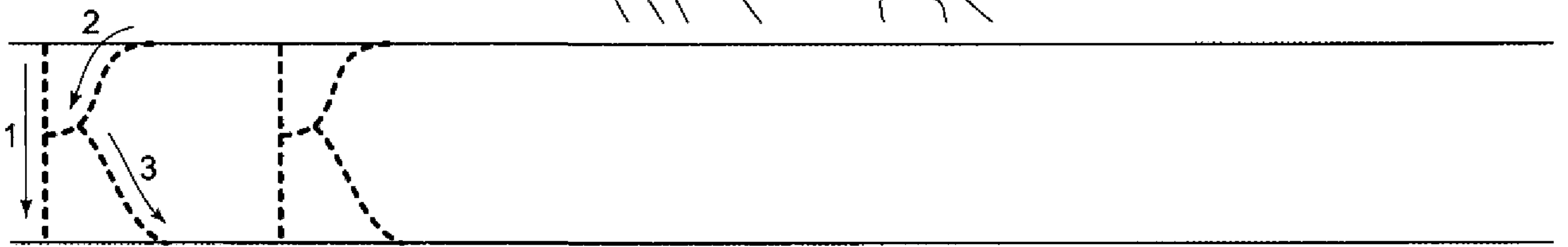

Выполни штриховку прямыми параллельными линиями, не выходя за контур рисунка. Раскрась картинки.

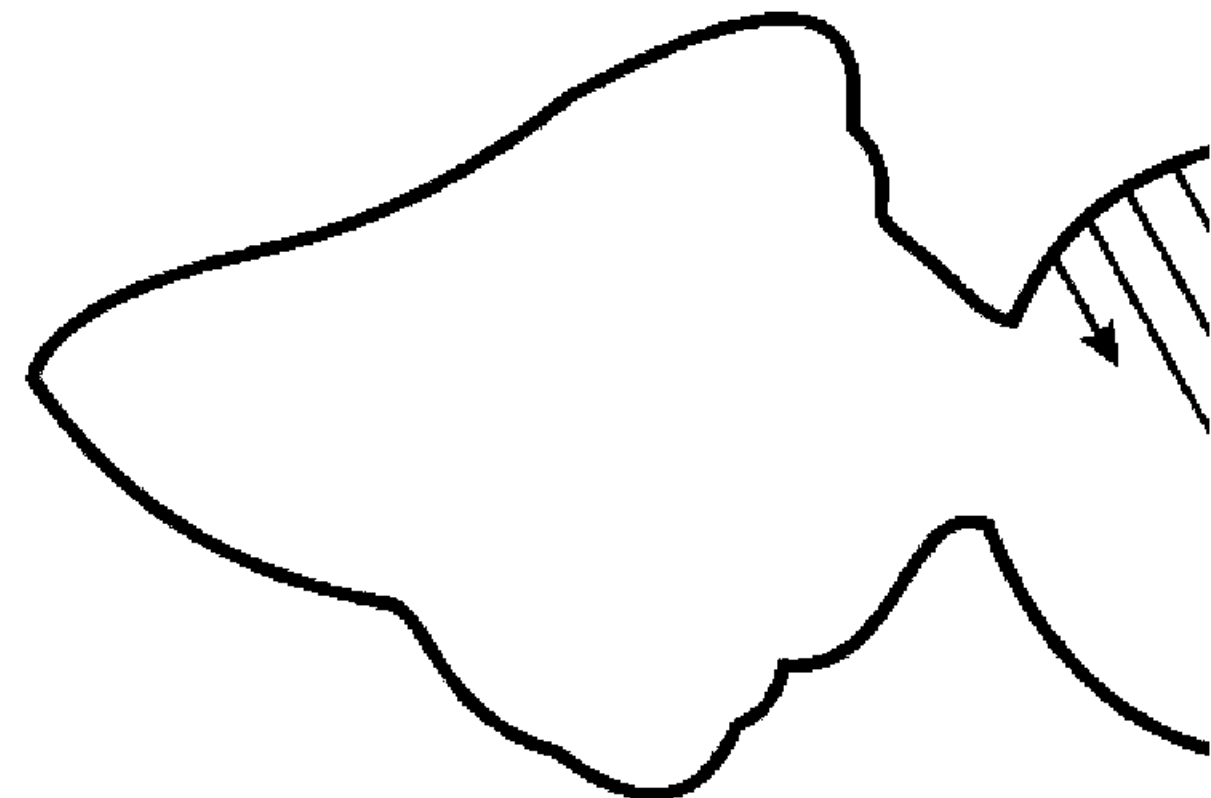
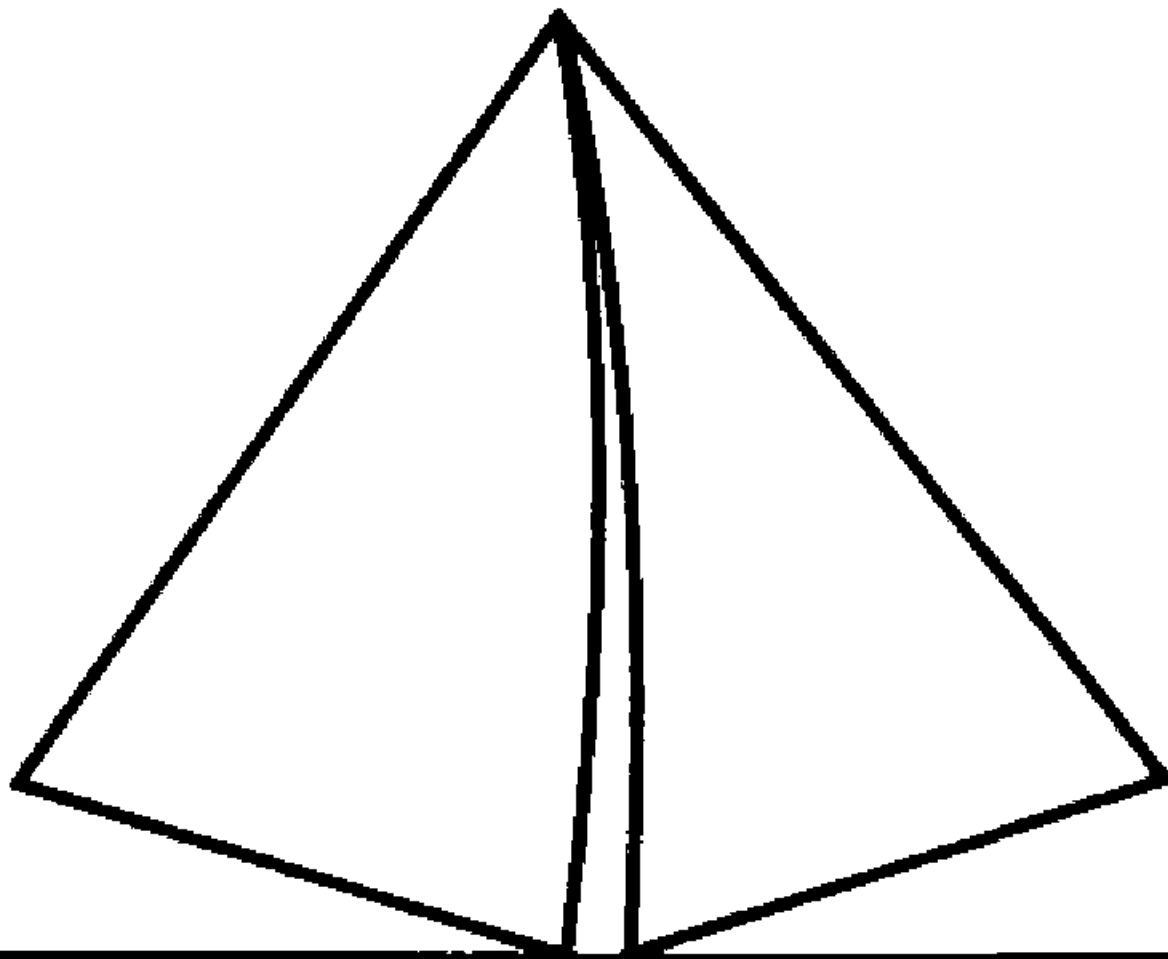
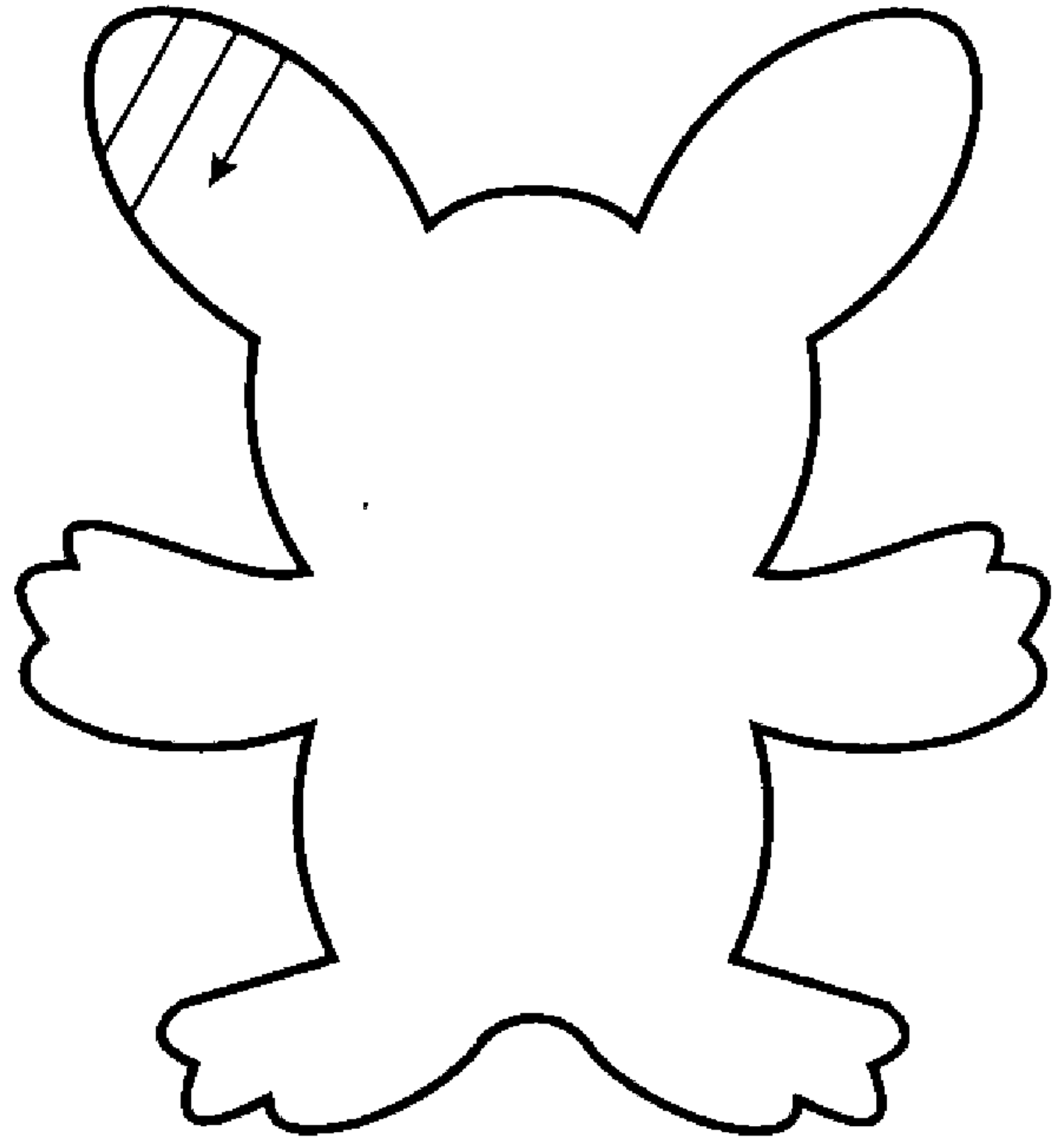
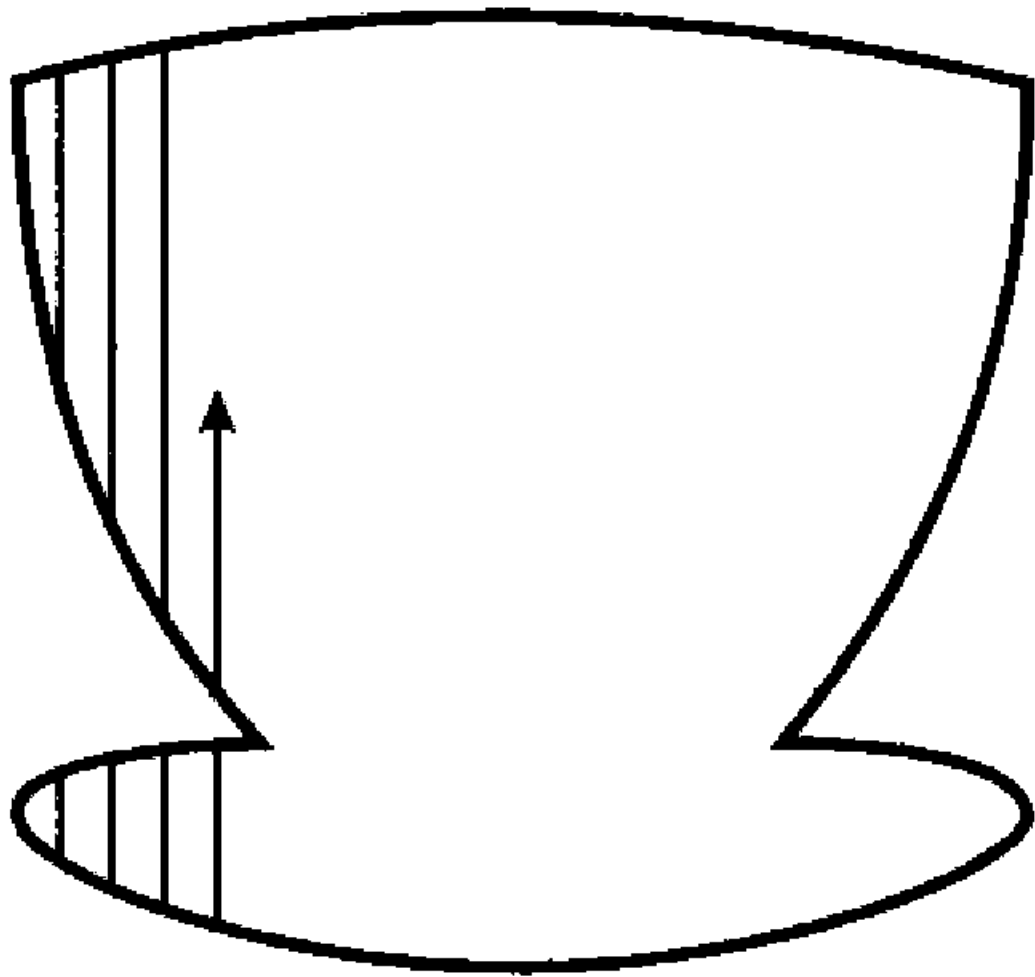
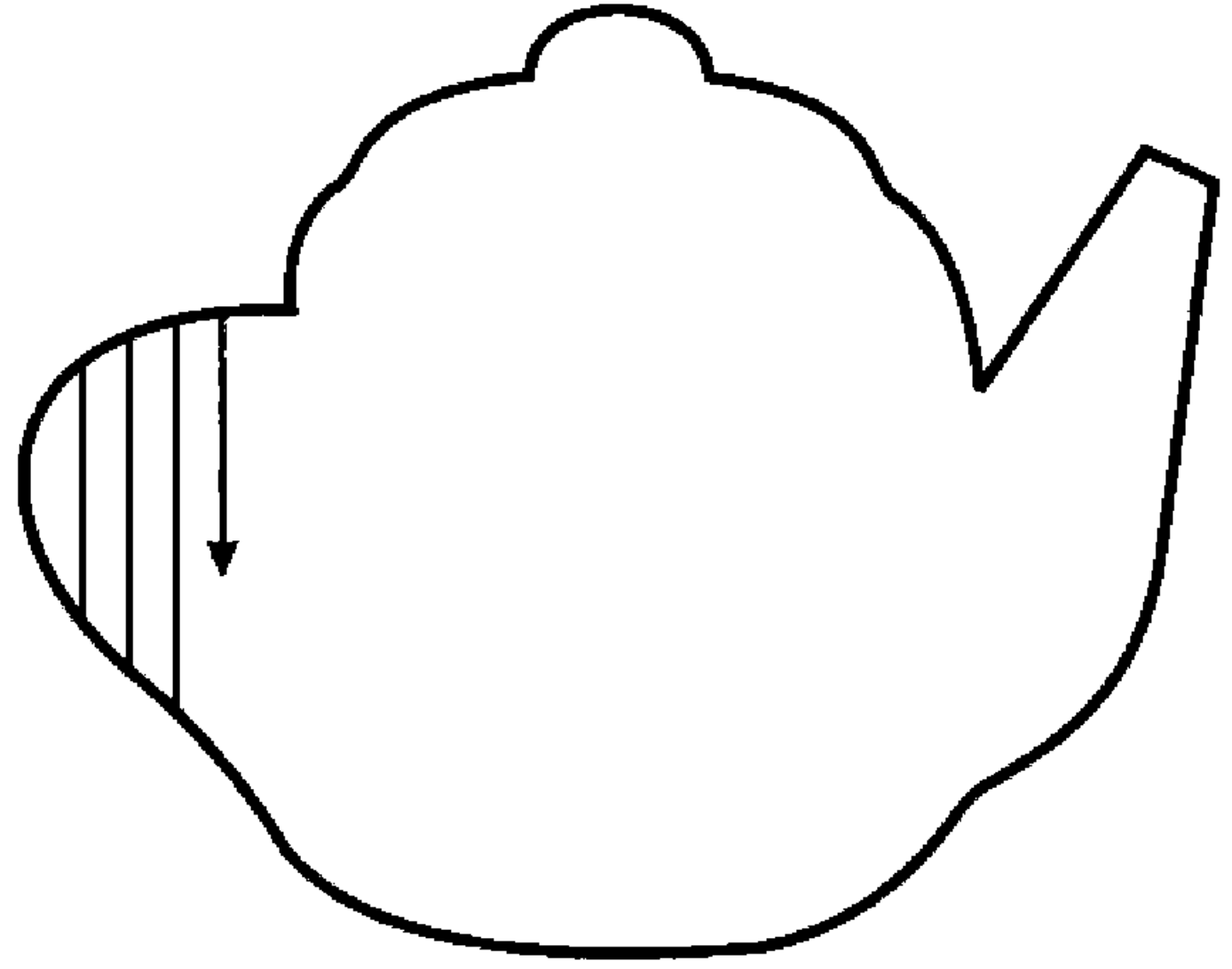
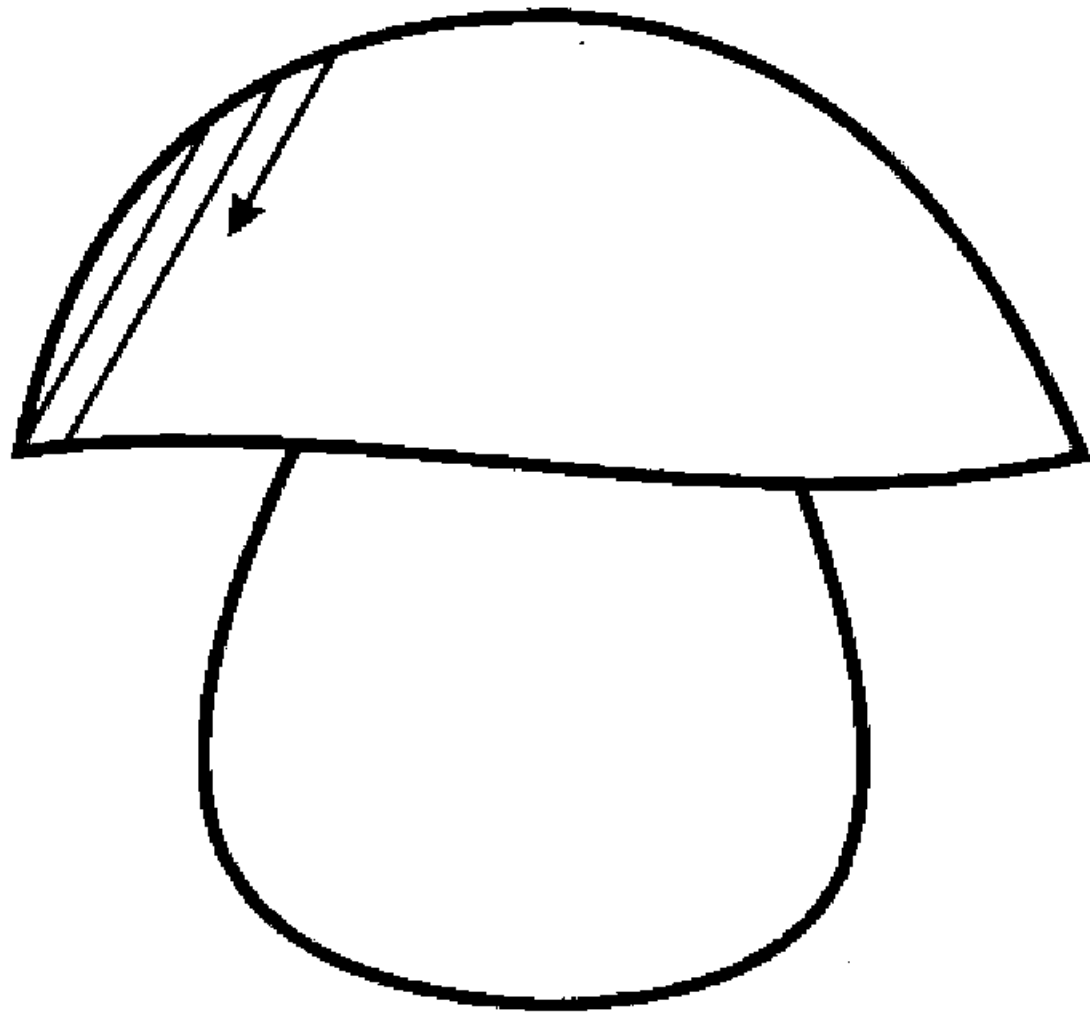

Л

Лев

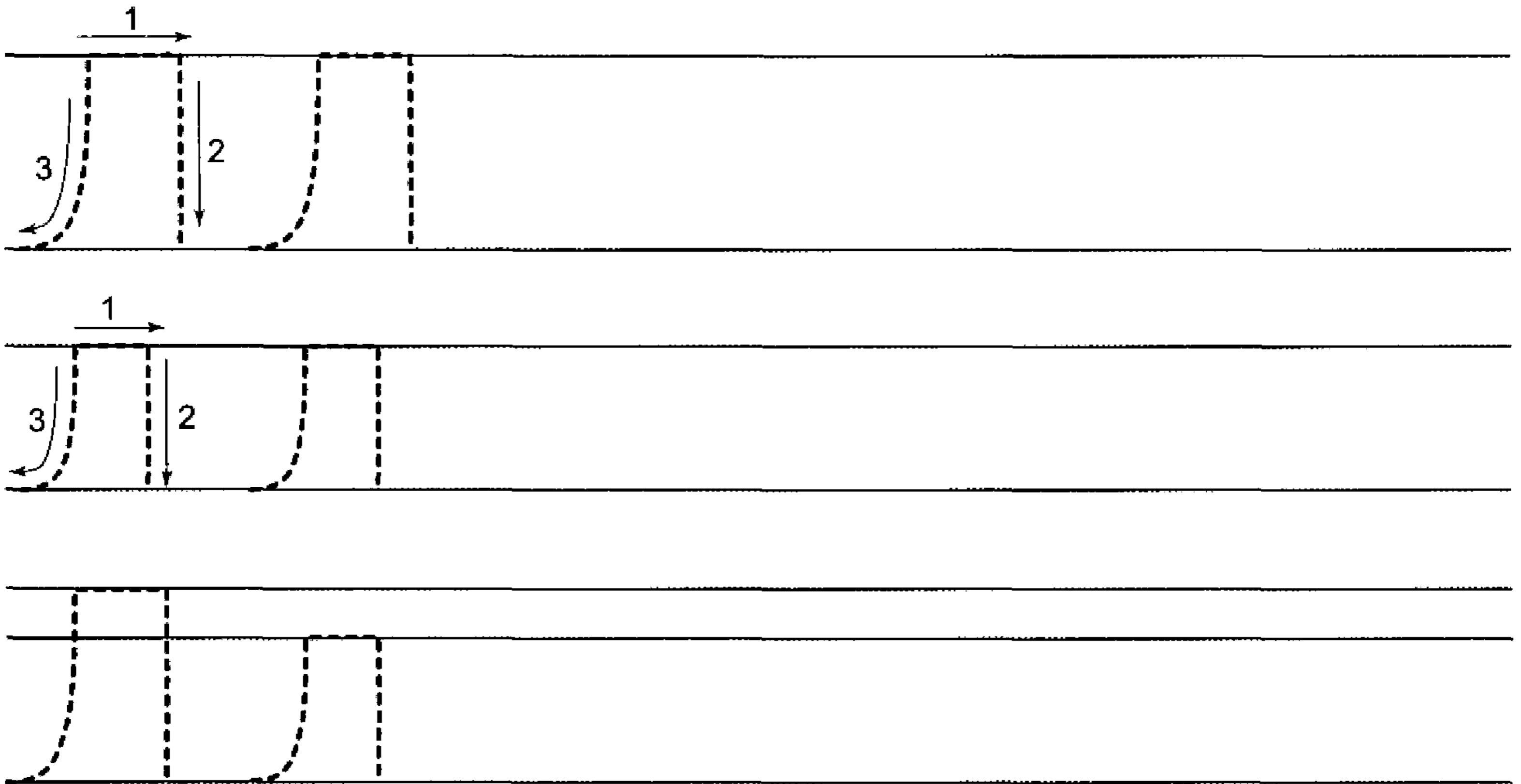
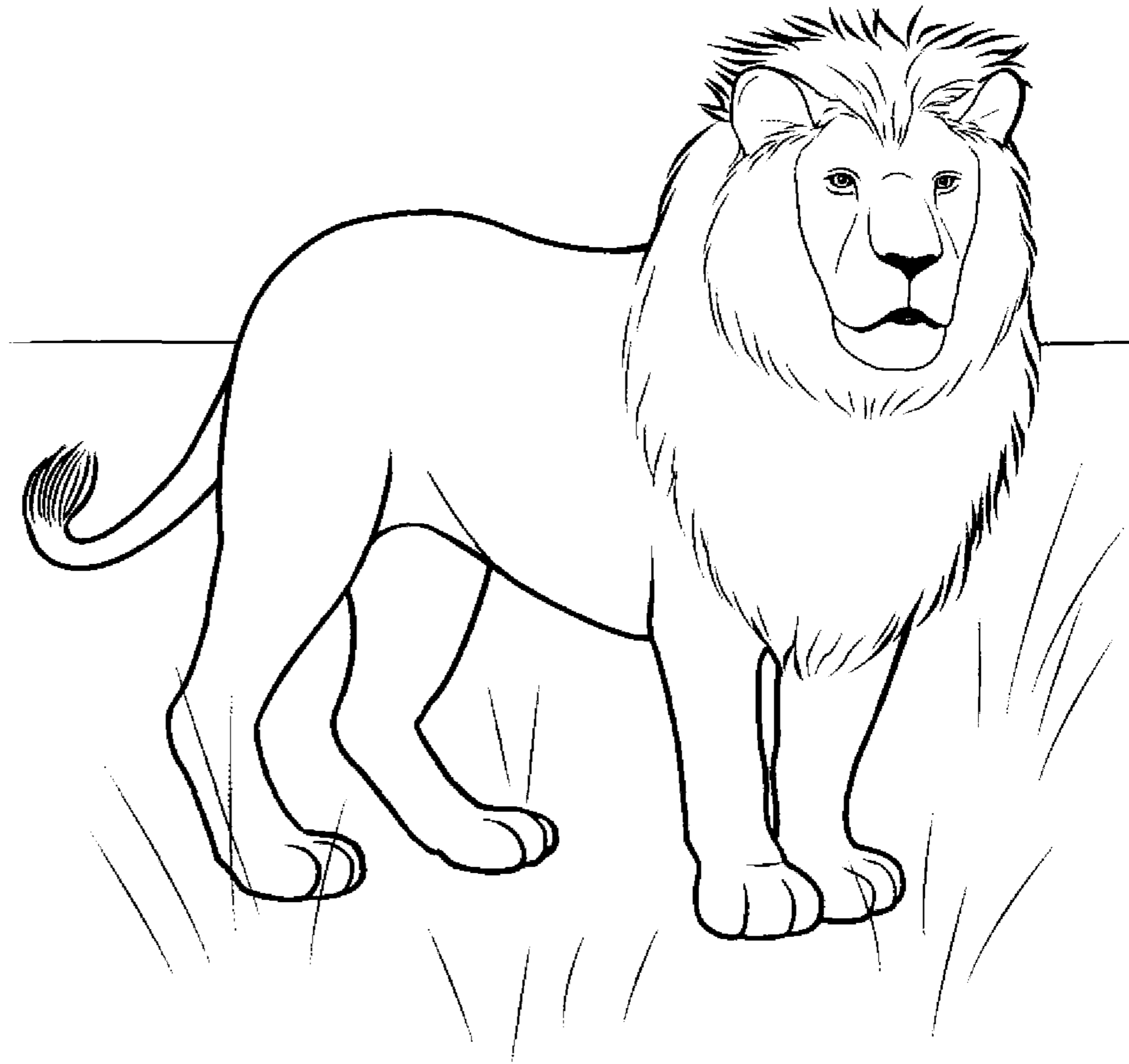

Дорисуй фигуры до конца строки и раскрась их.

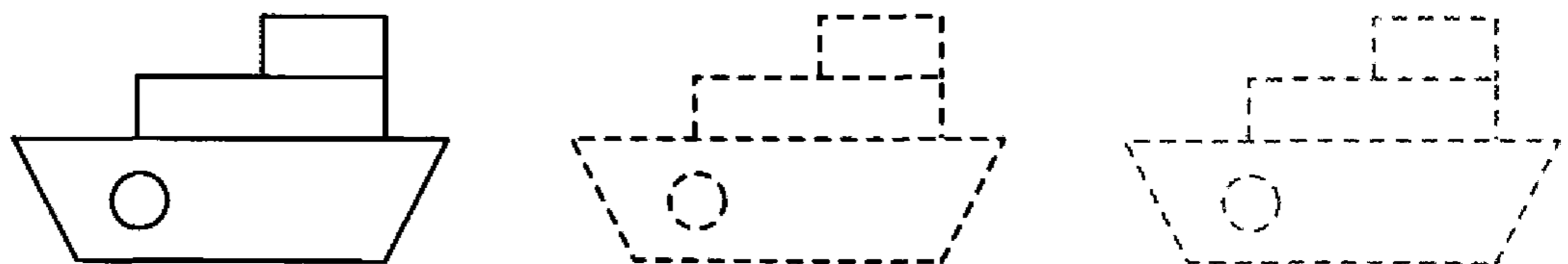
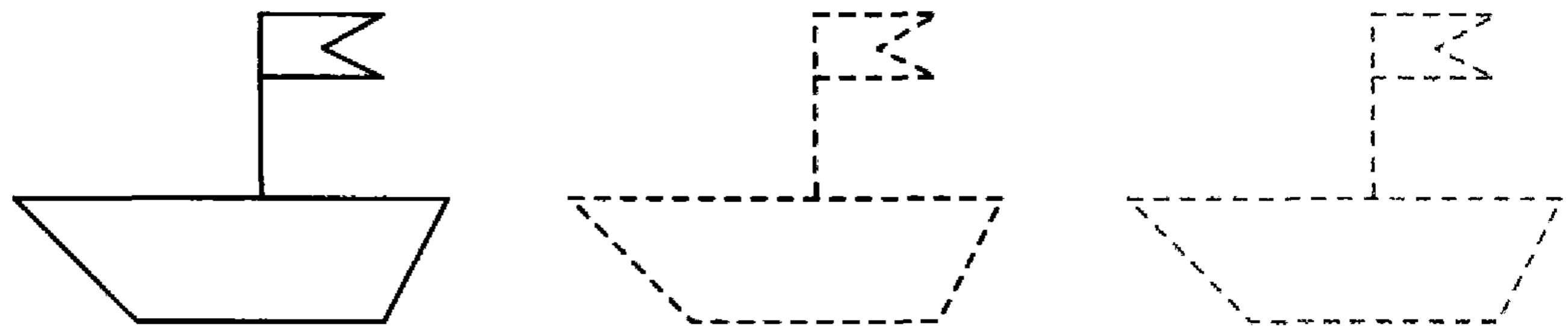
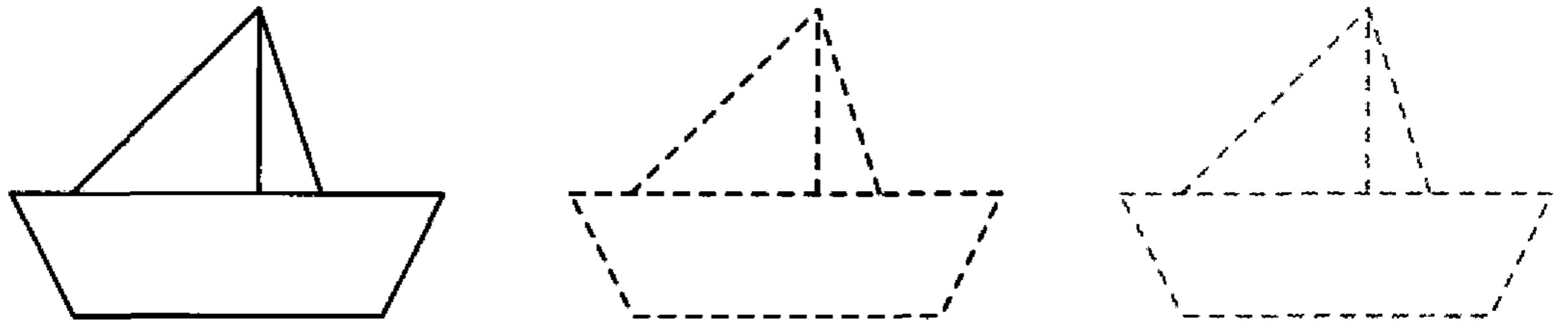
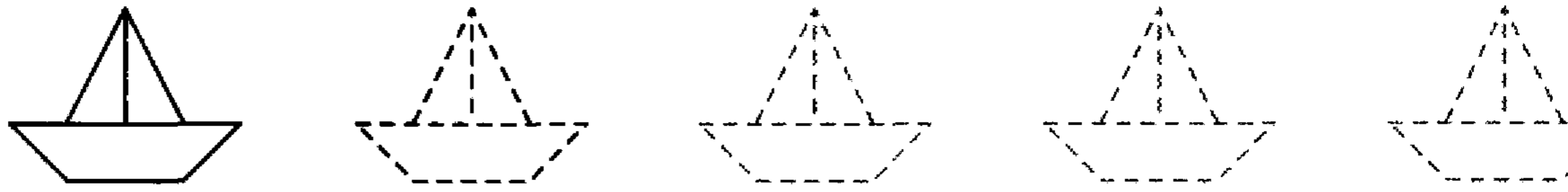
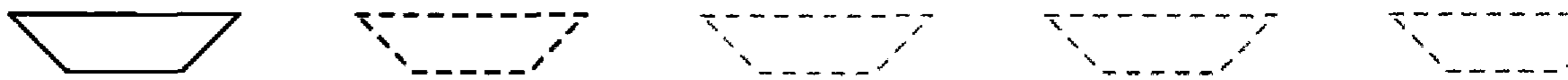
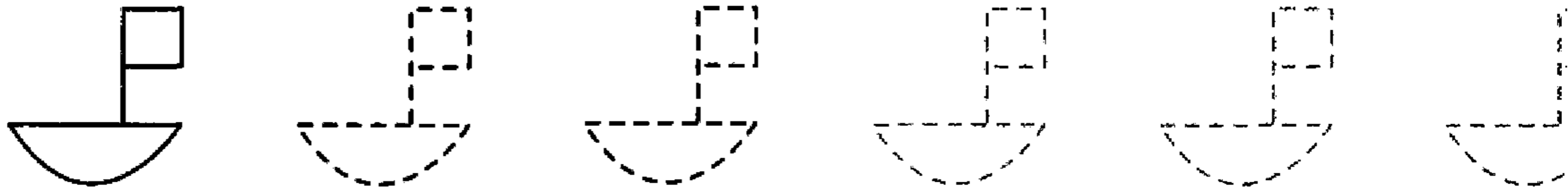

M

Медведь

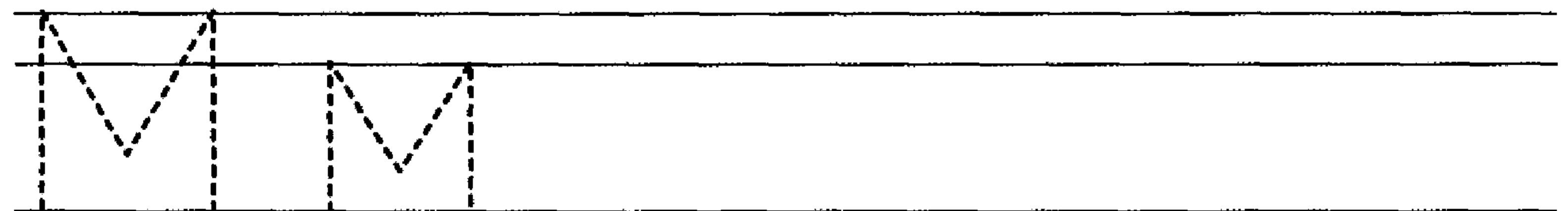
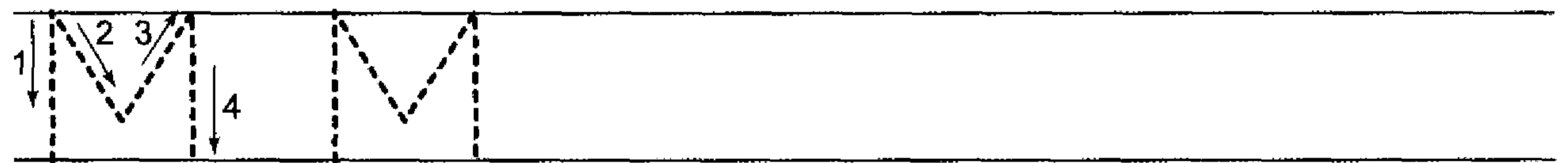
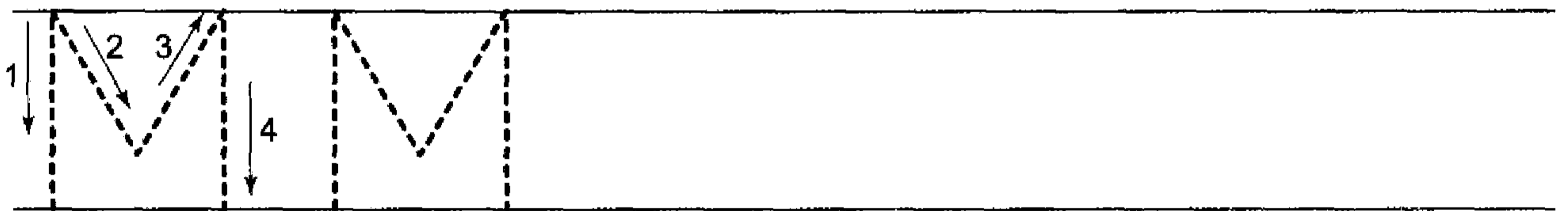
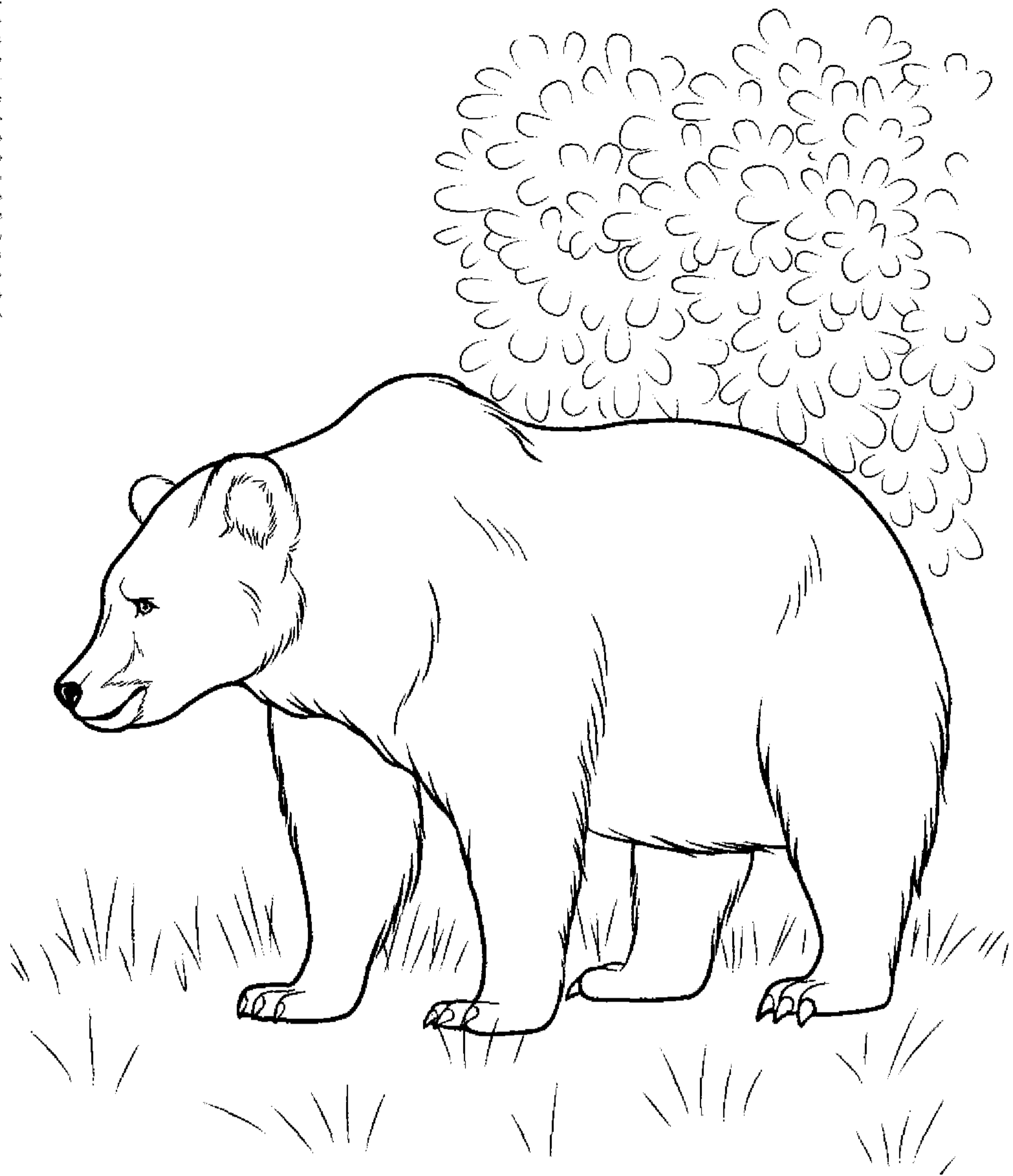

Проведи линии по дорожкам, не отрывая карандаш от бумаги и не выходя за края дорожек. Раскрась дорожки.

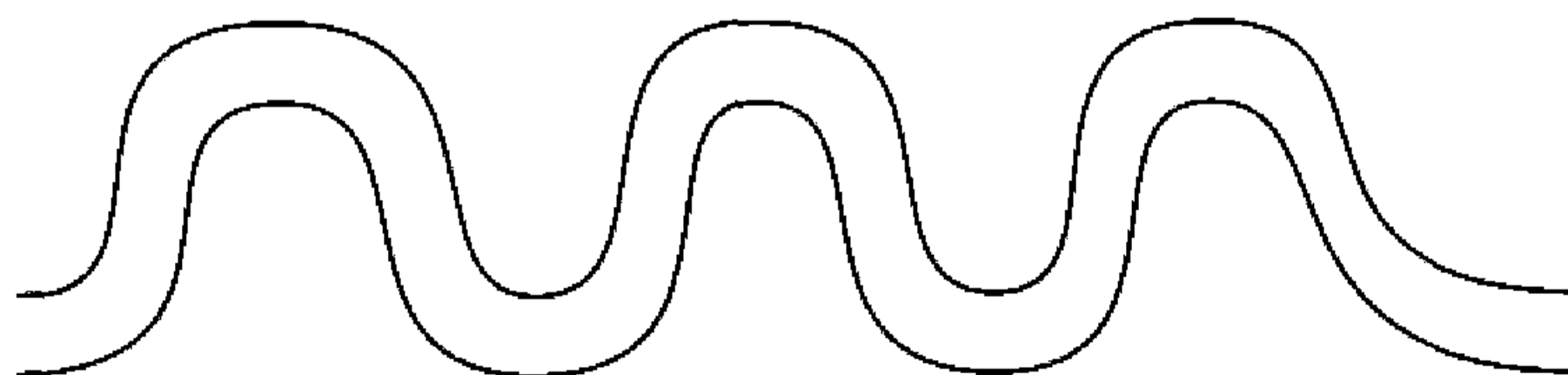
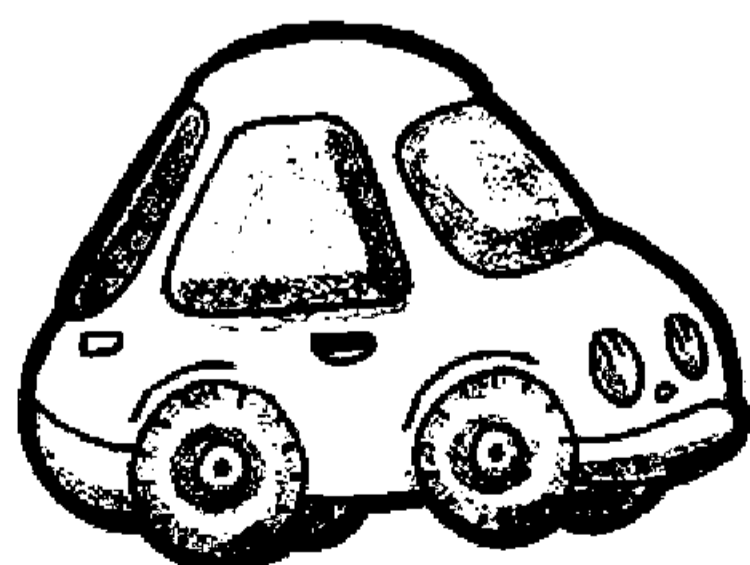
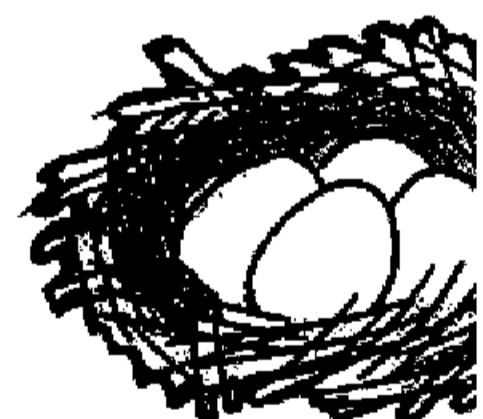
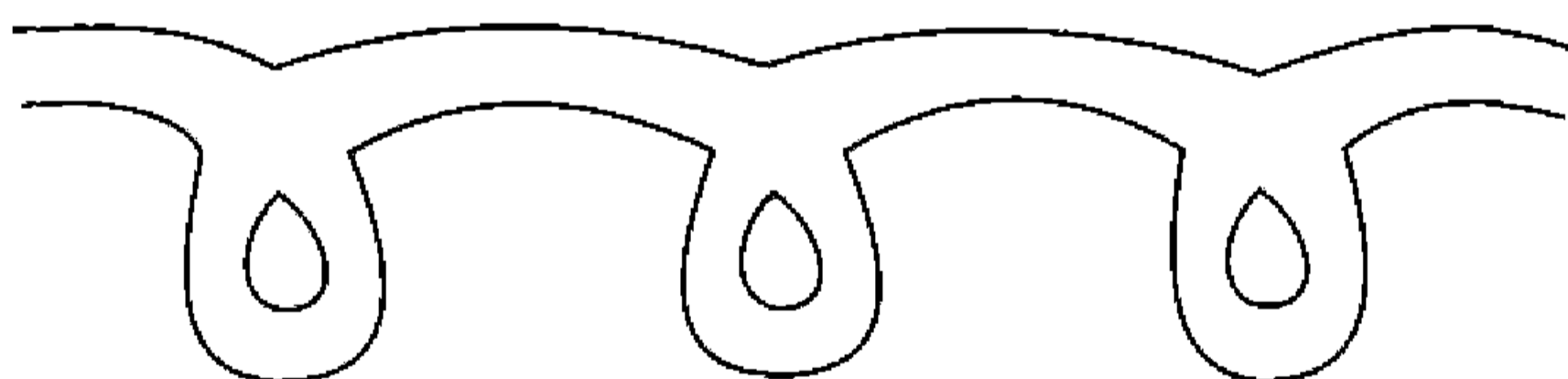
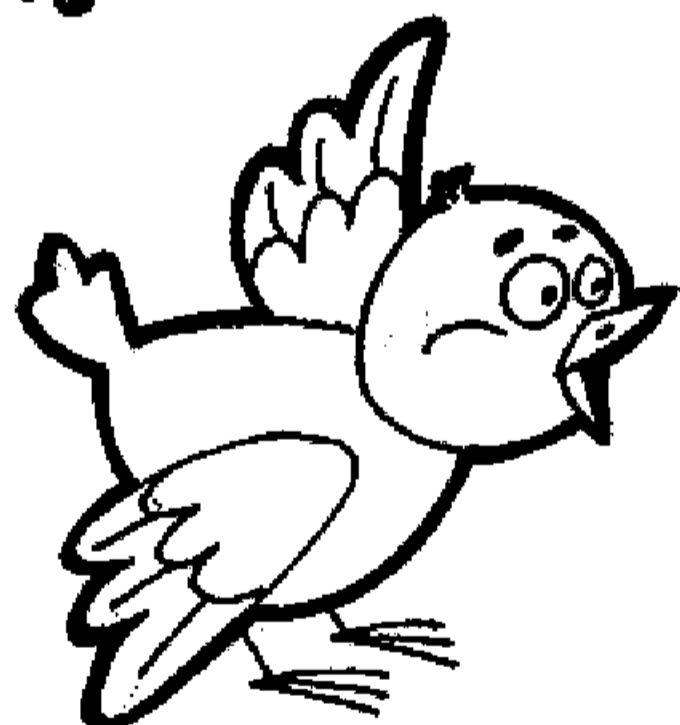
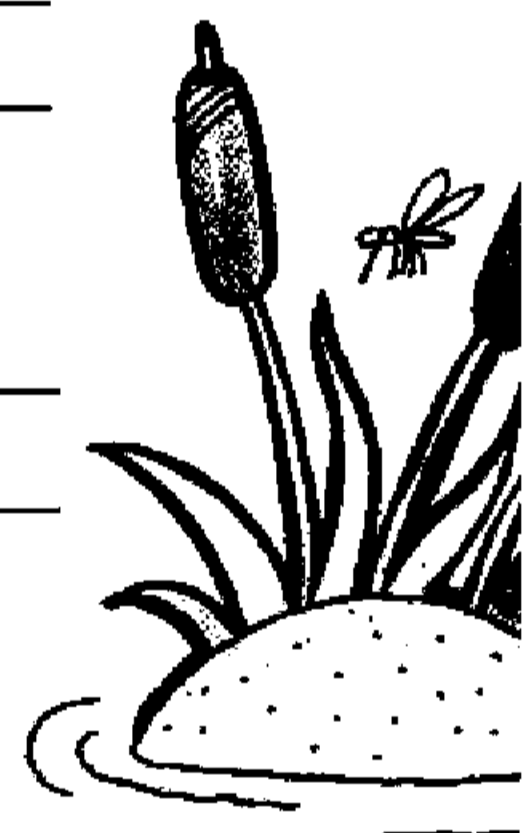
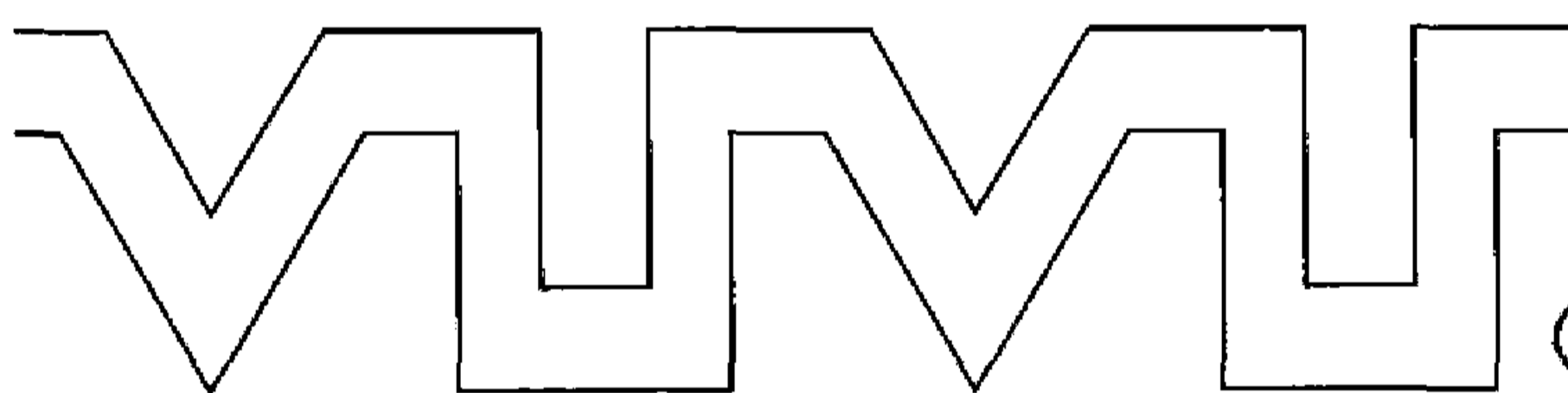
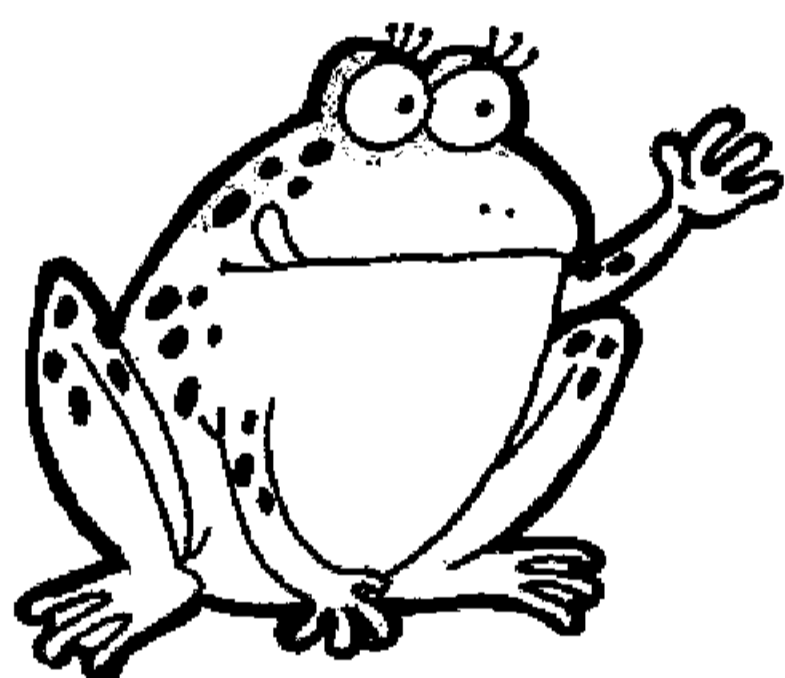
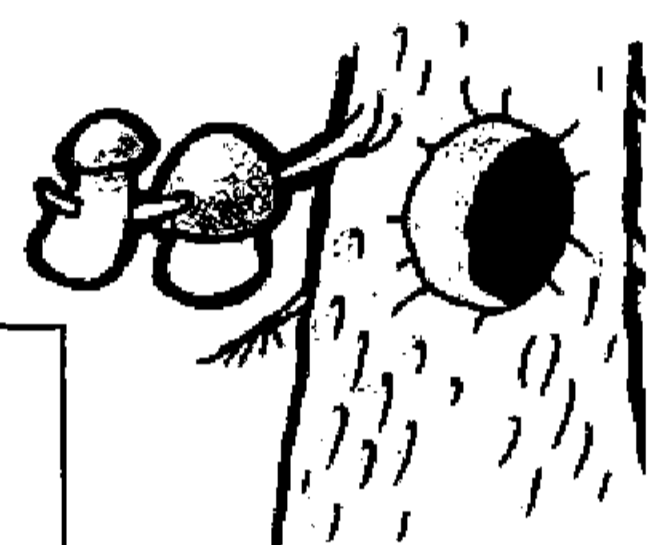
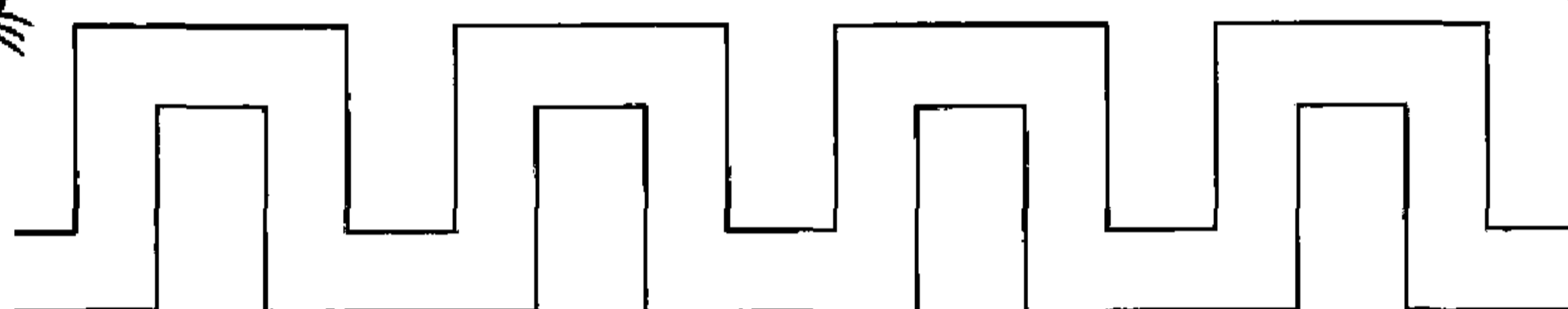
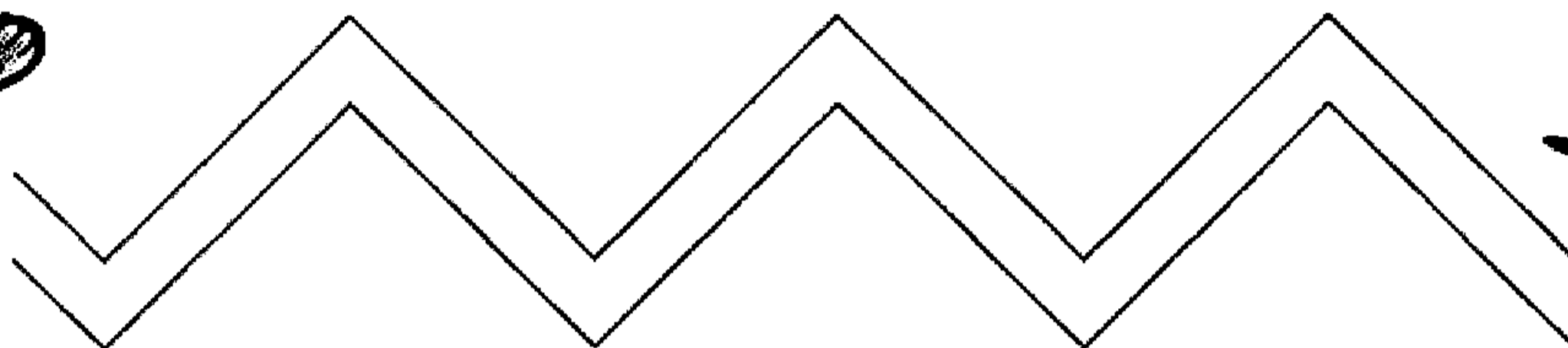

Н

Носорог

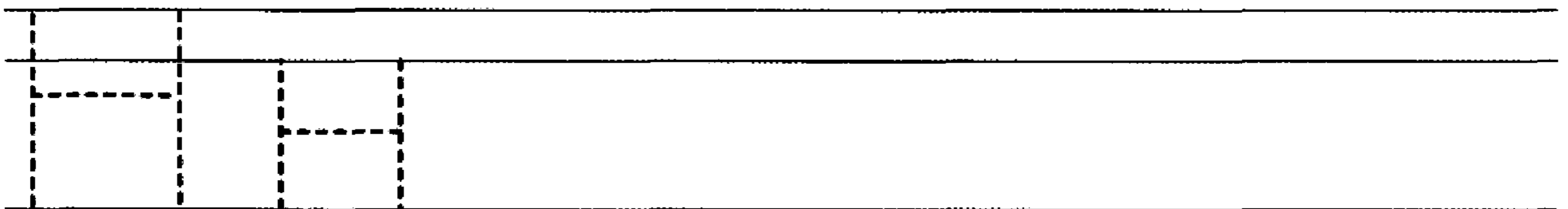
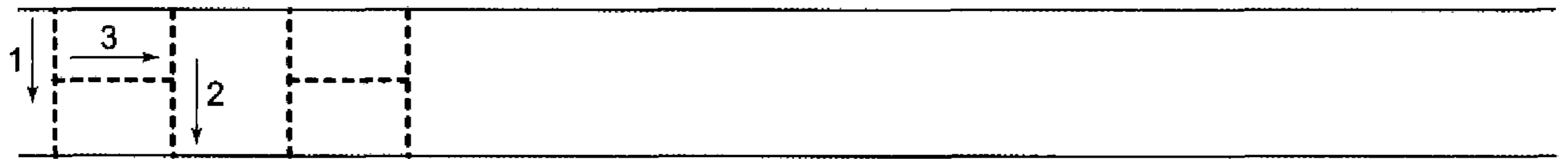
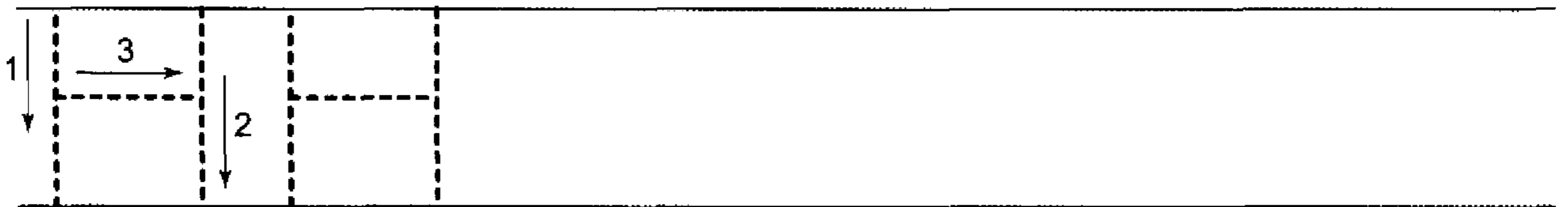
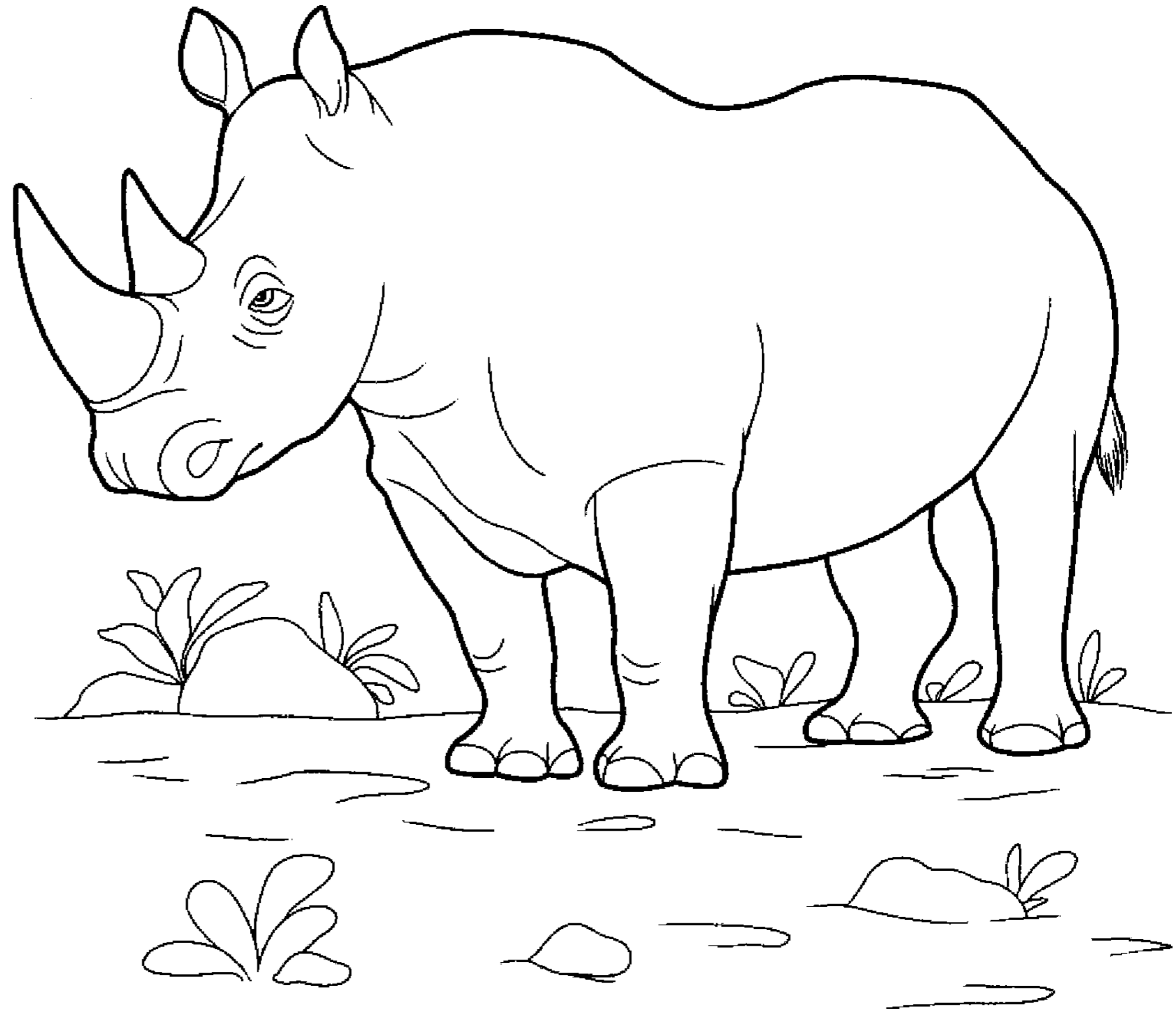

Выполни штриховку параллельными линиями, не выходя за контур рисунка. Раскрась картинки.

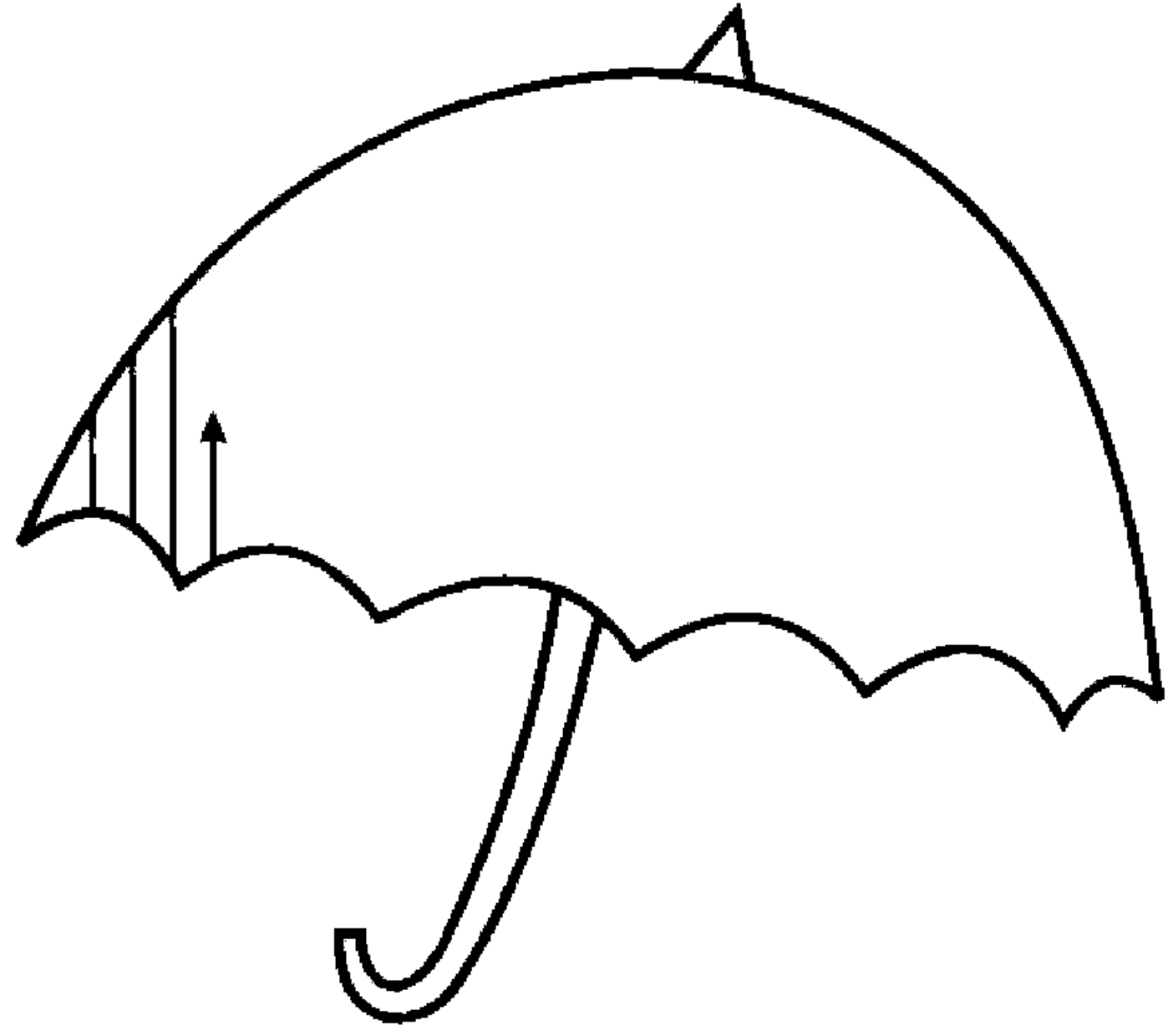
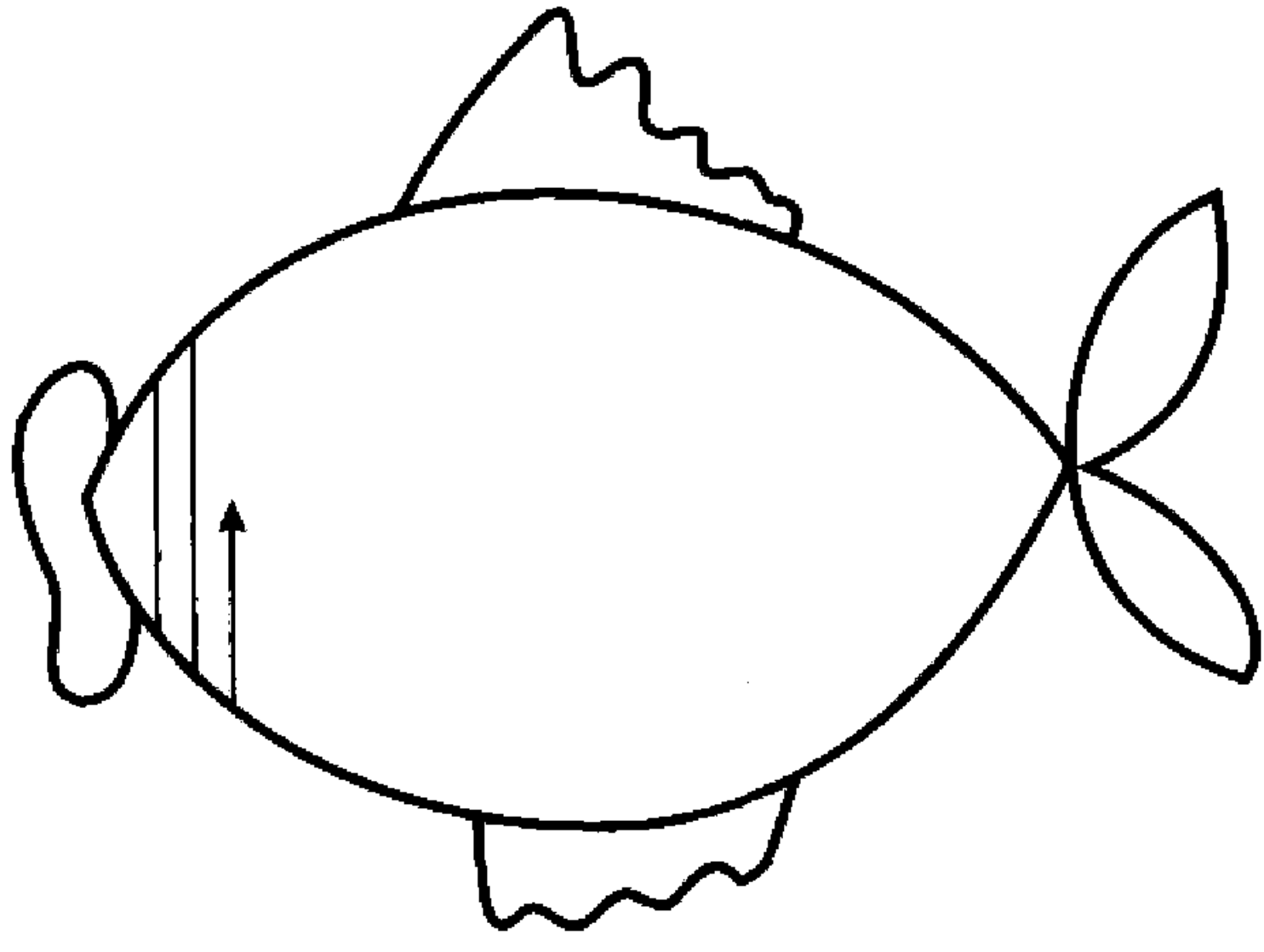
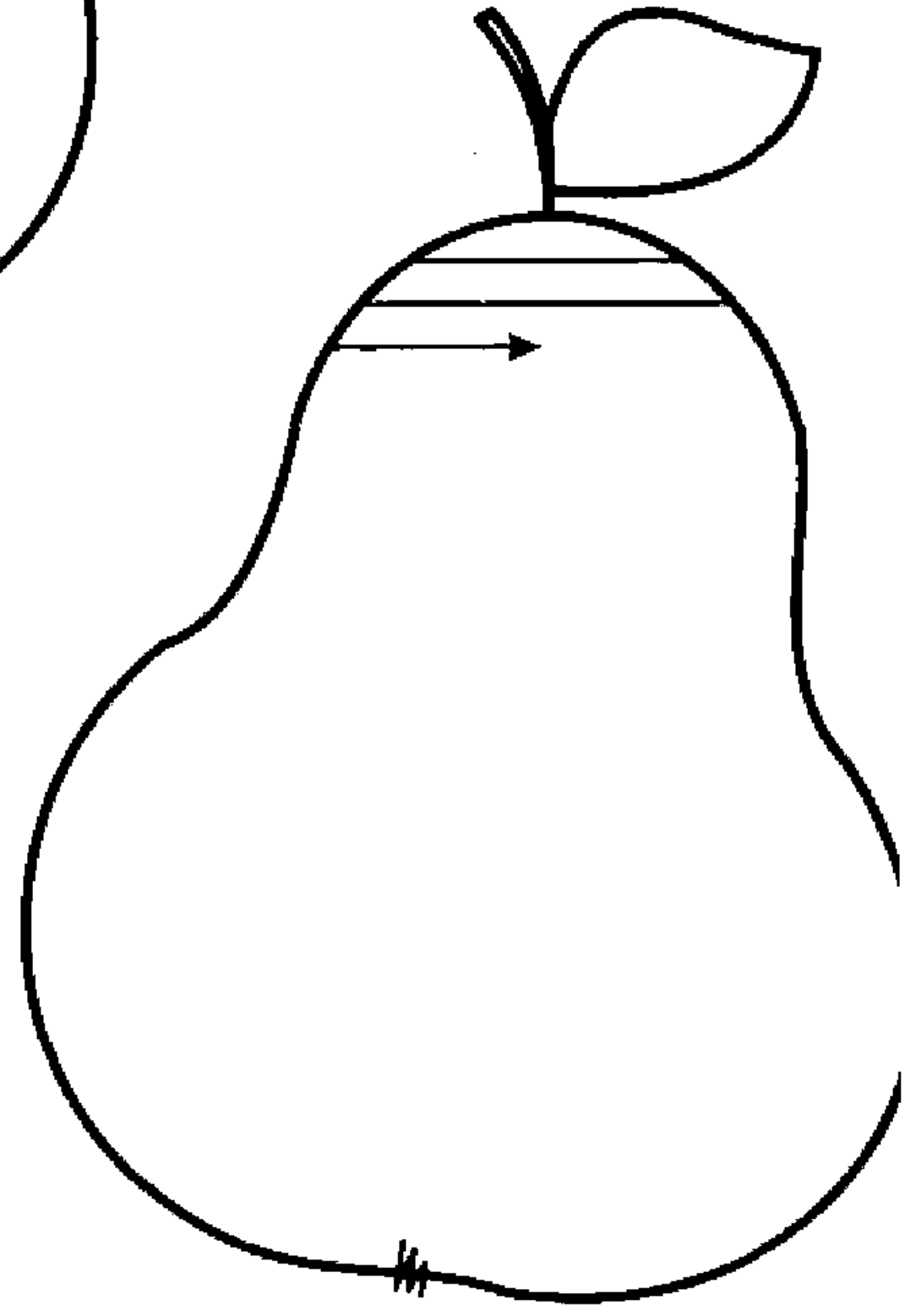
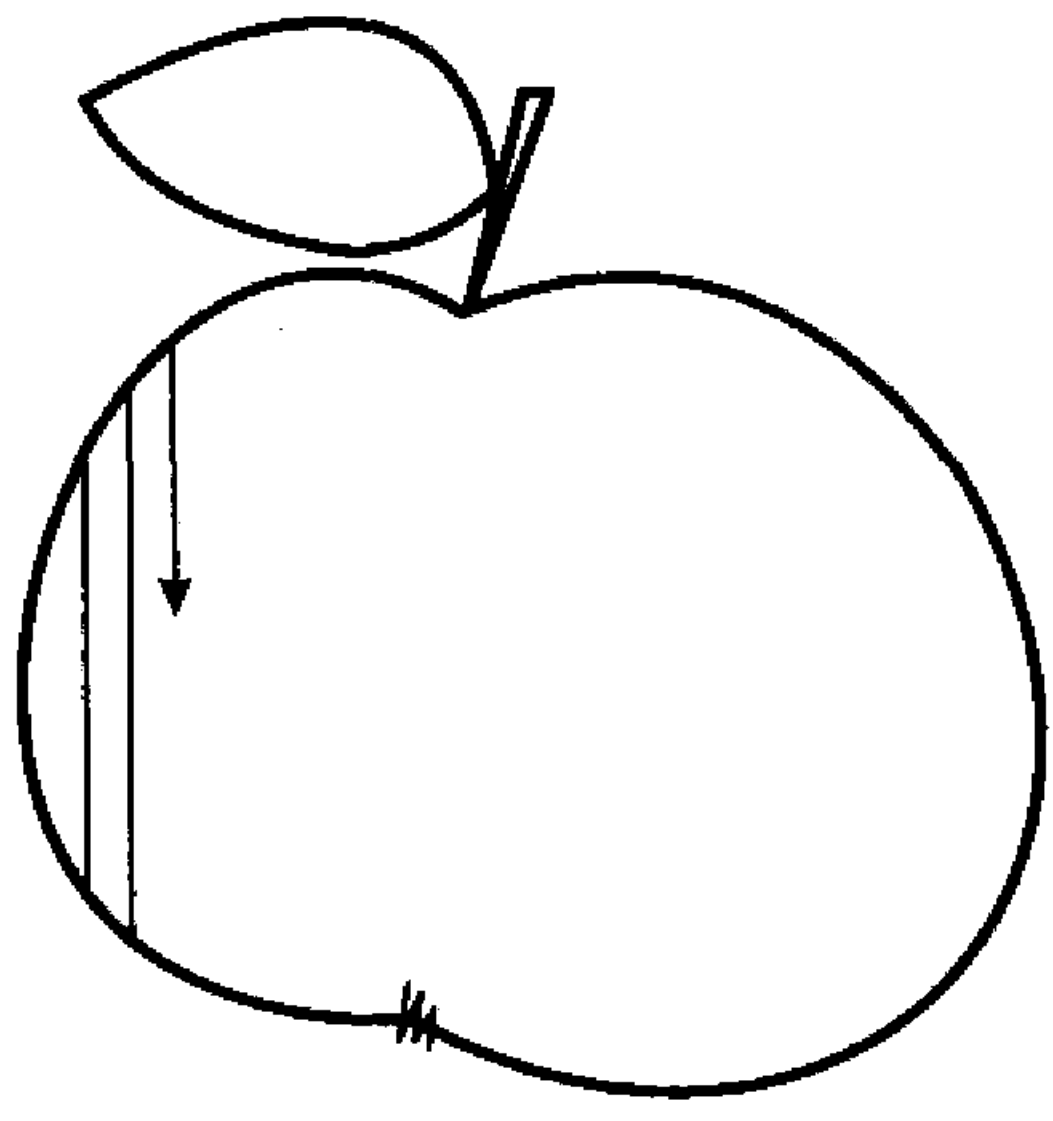
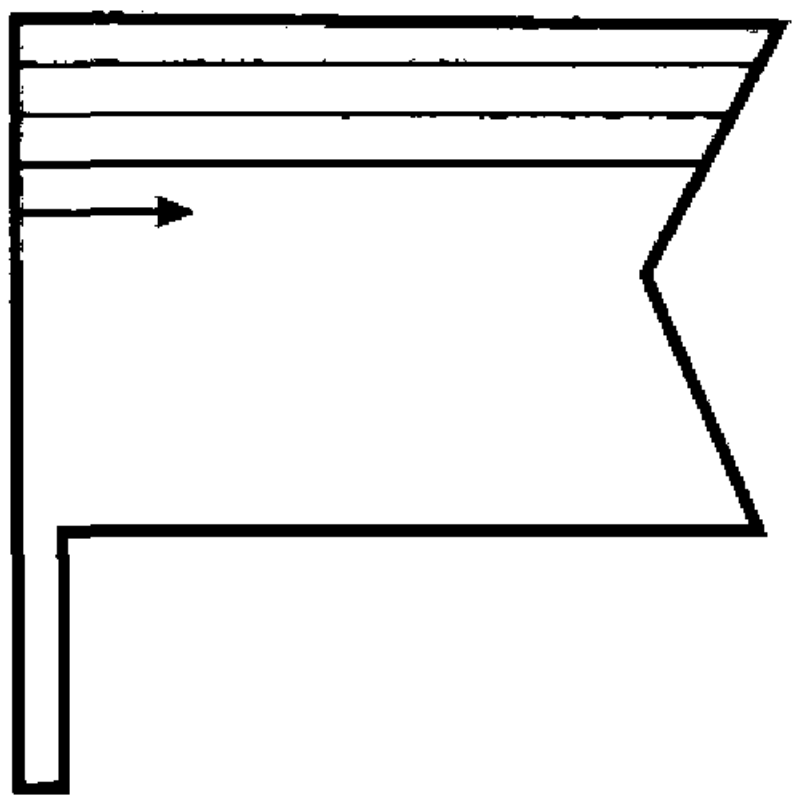

O

Орёл

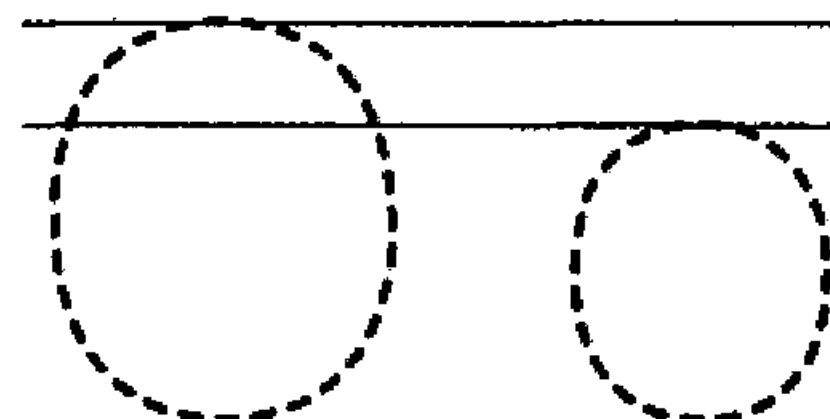
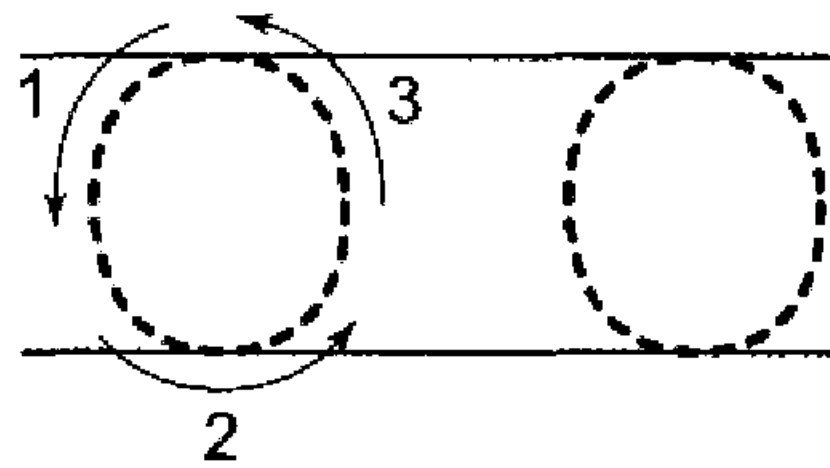
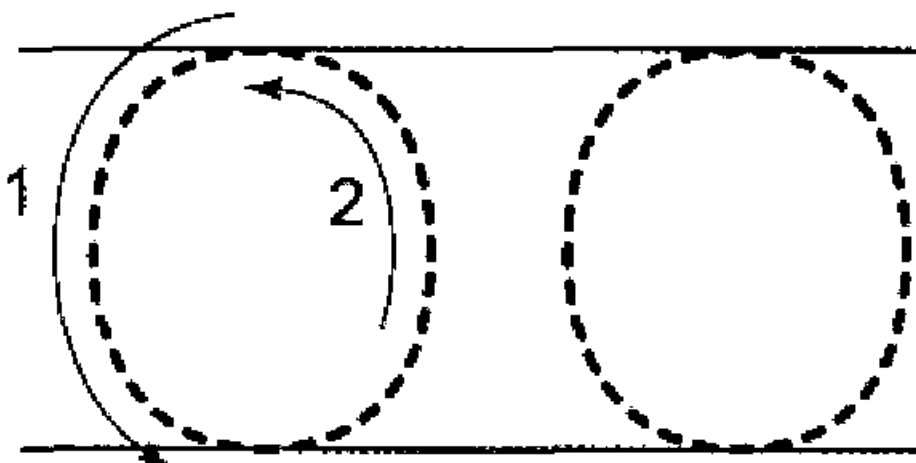

Обведи картинки точно по линиям, не отрывая карандаш от бумаги. Раскрась картинки.

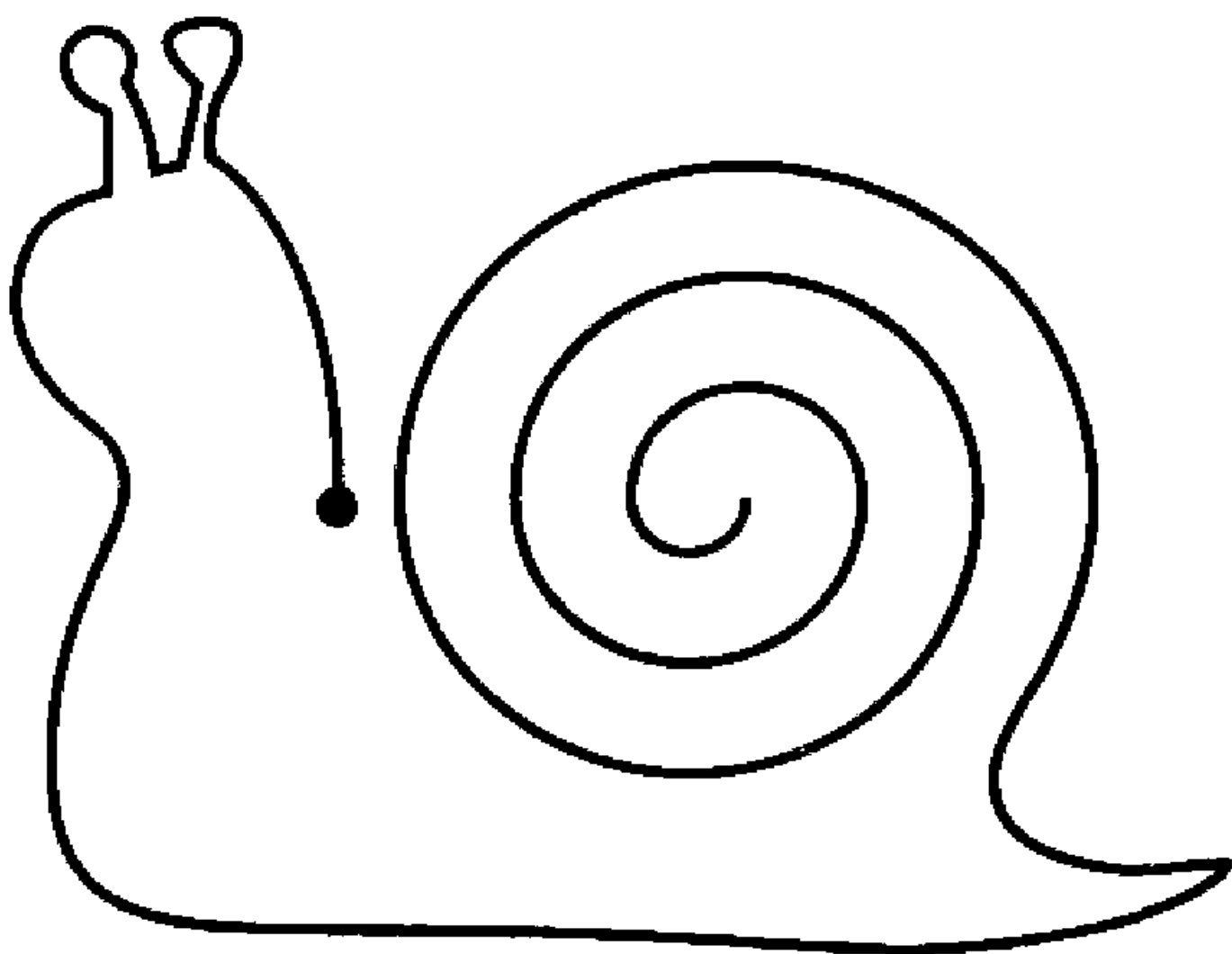
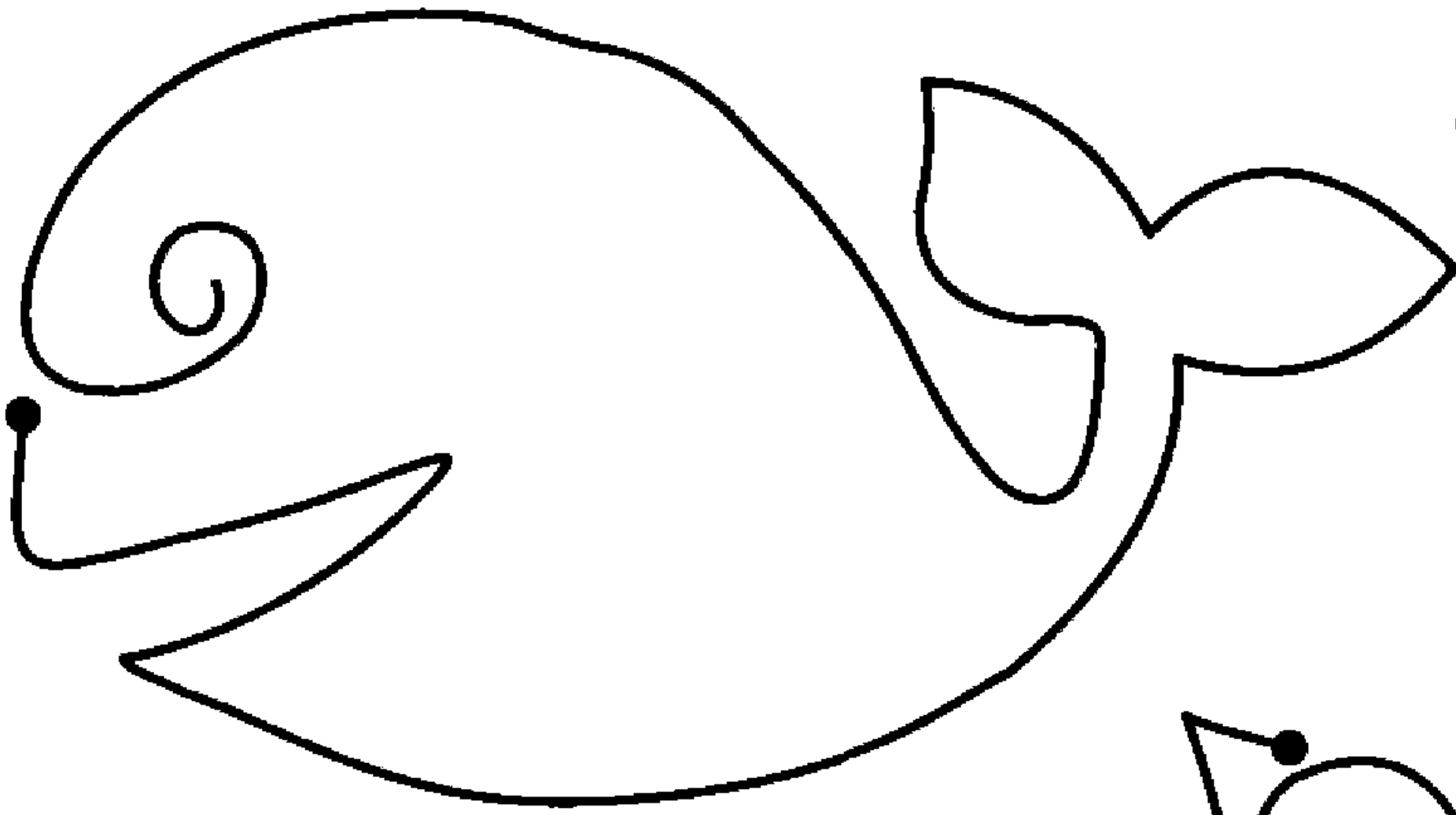
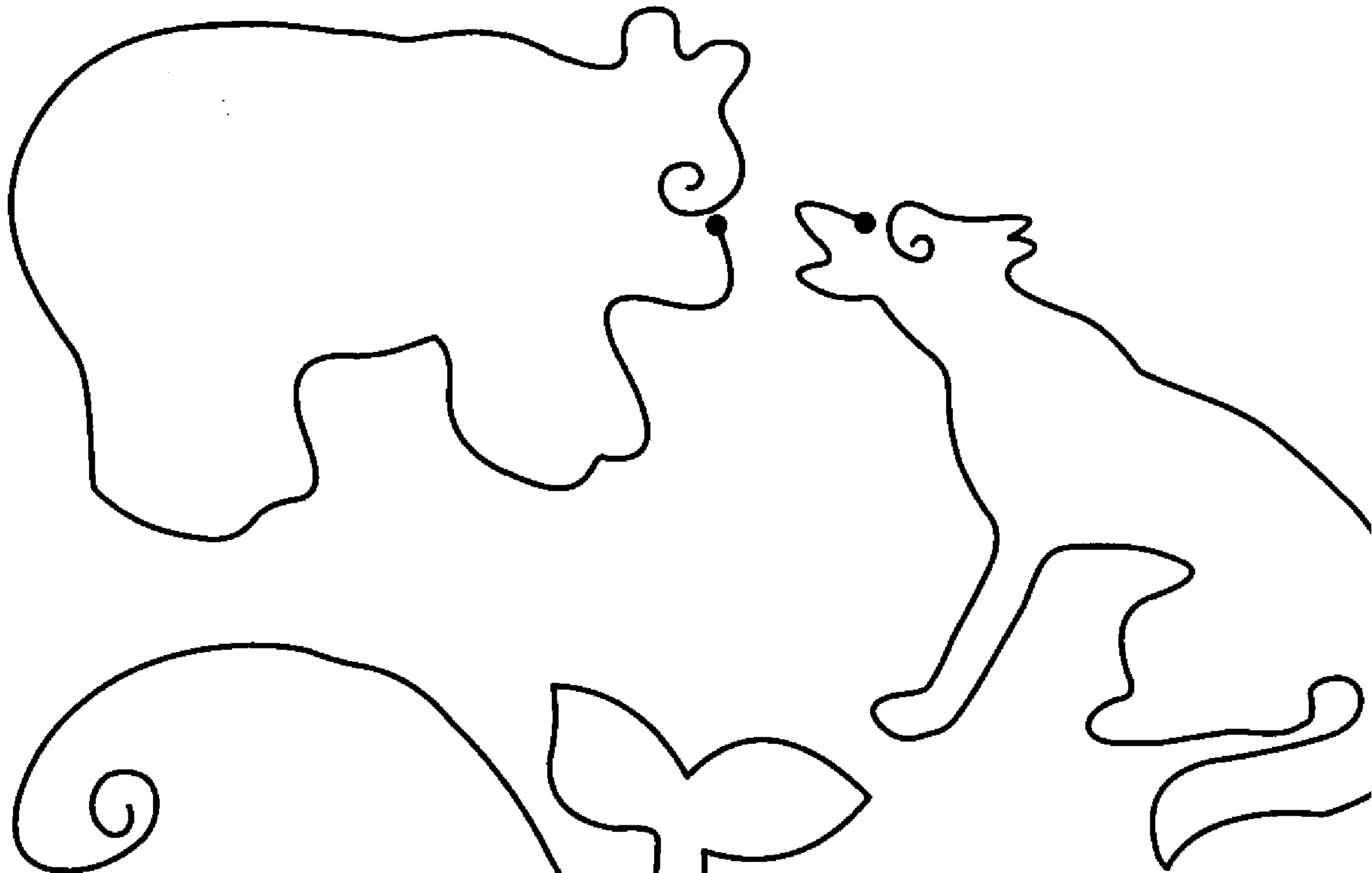

П

Панда

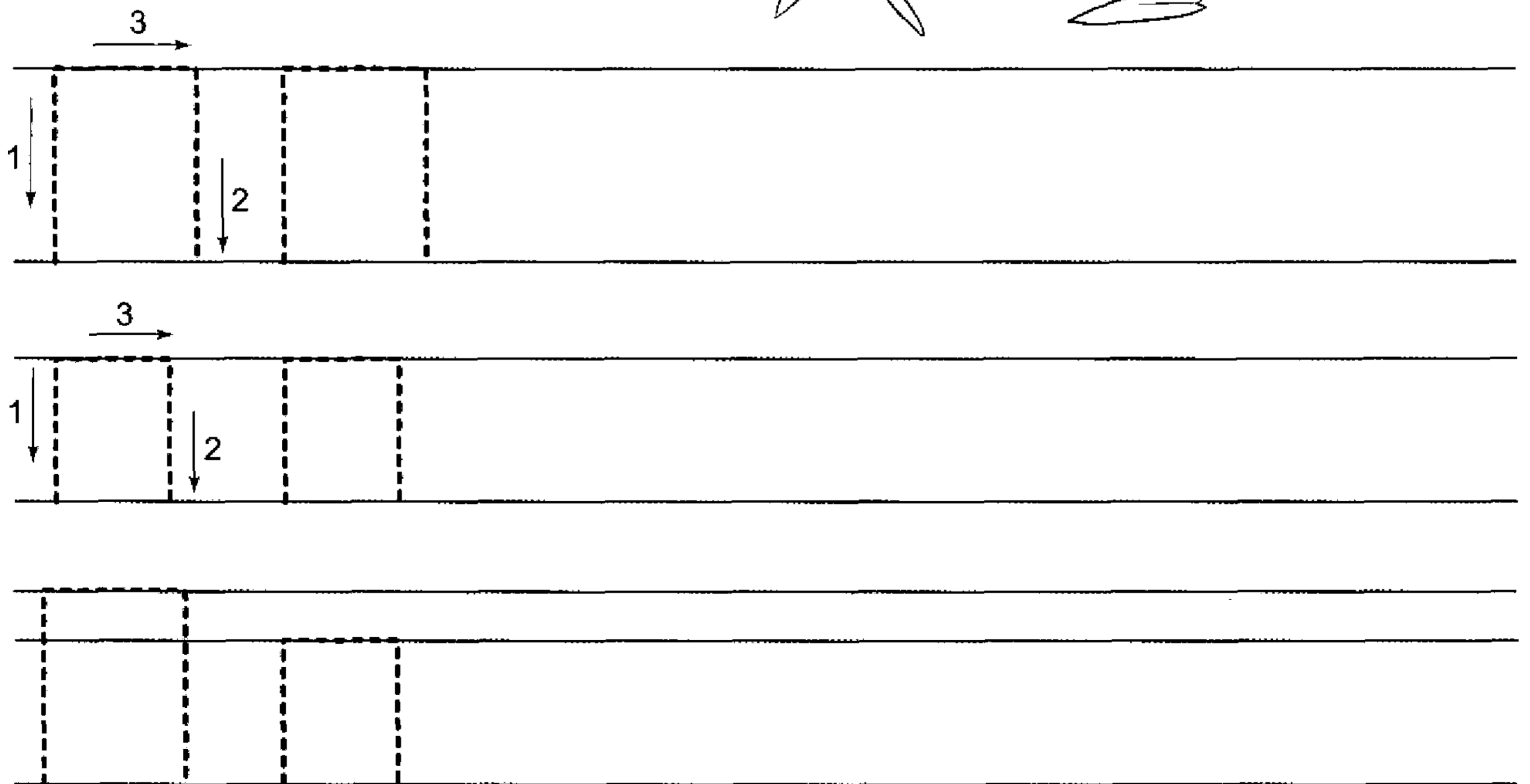

Нарисуй от точки фигуры по образцу и раскрась их.

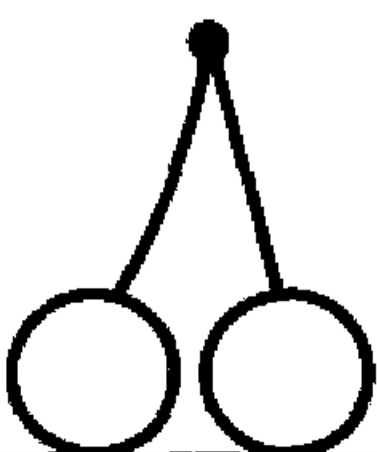
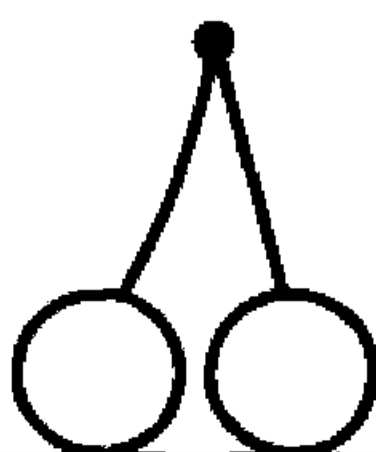
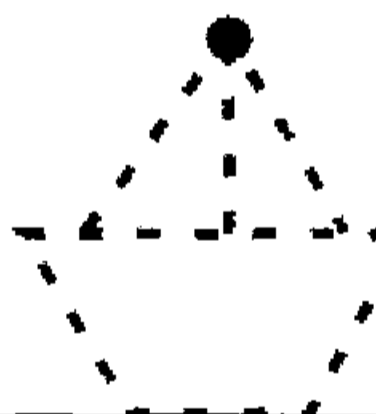
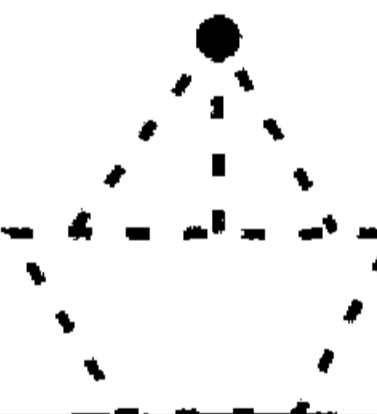
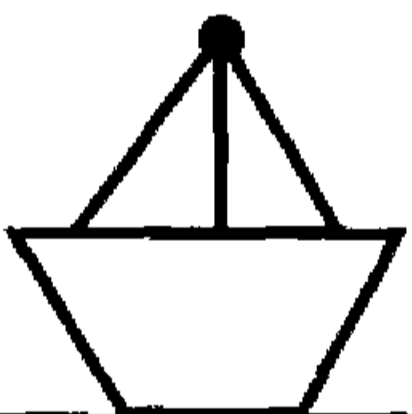
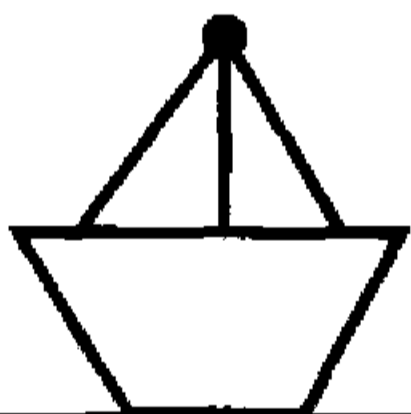
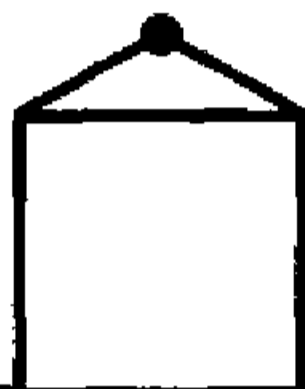
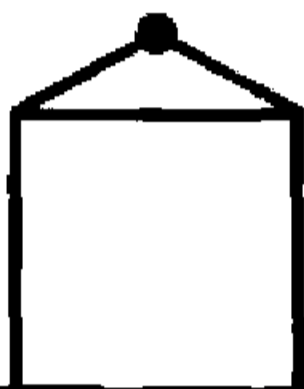
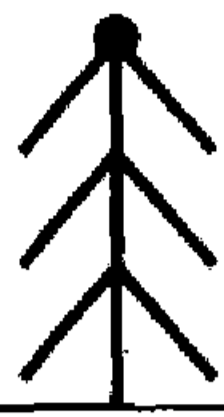
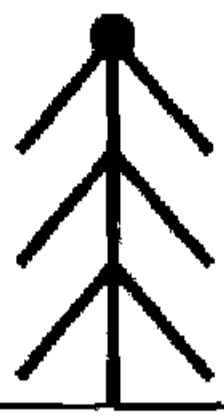

P

РЫСЬ

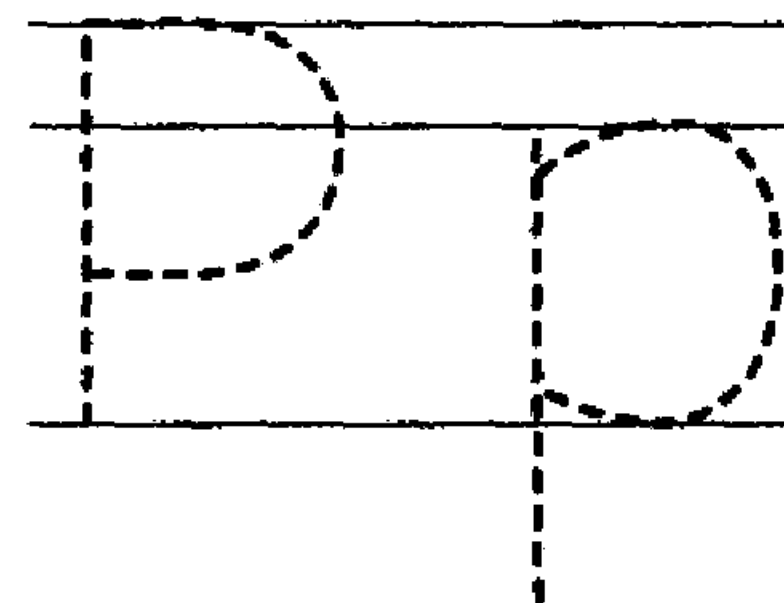
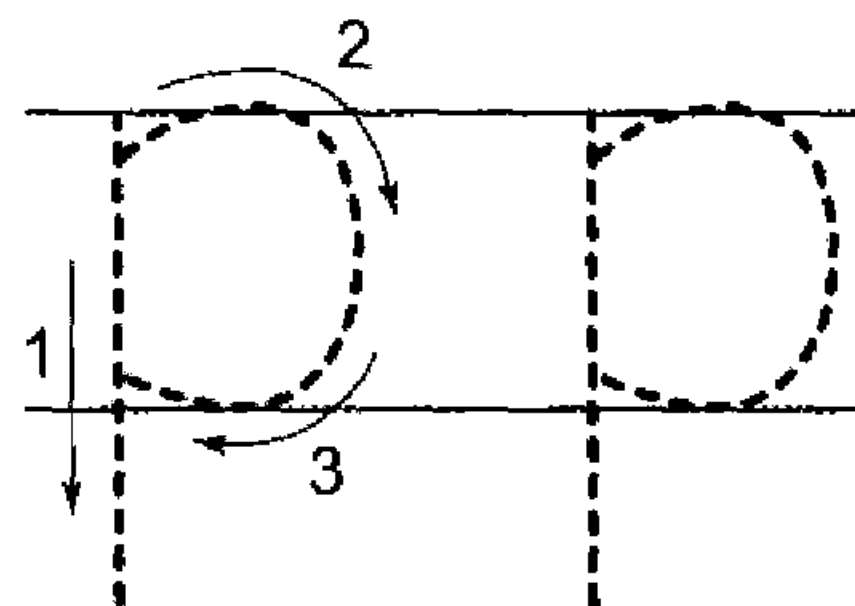
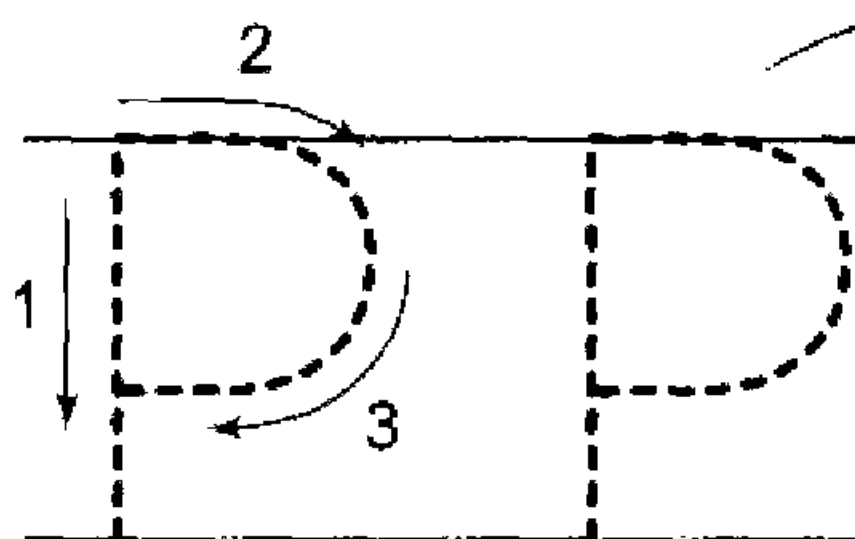
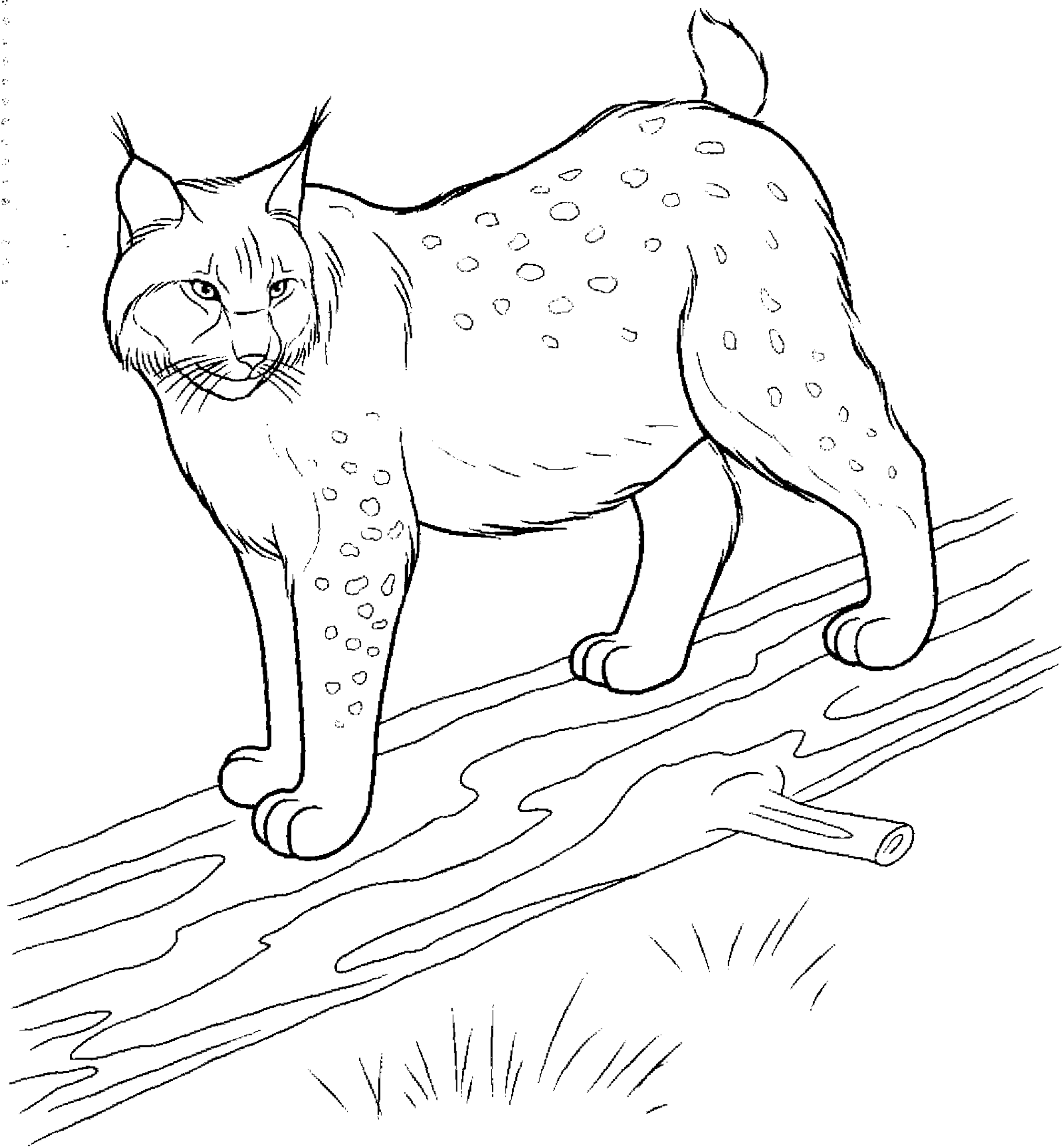

Обведи рисунки точно по пунктирной линии и раскрась их.

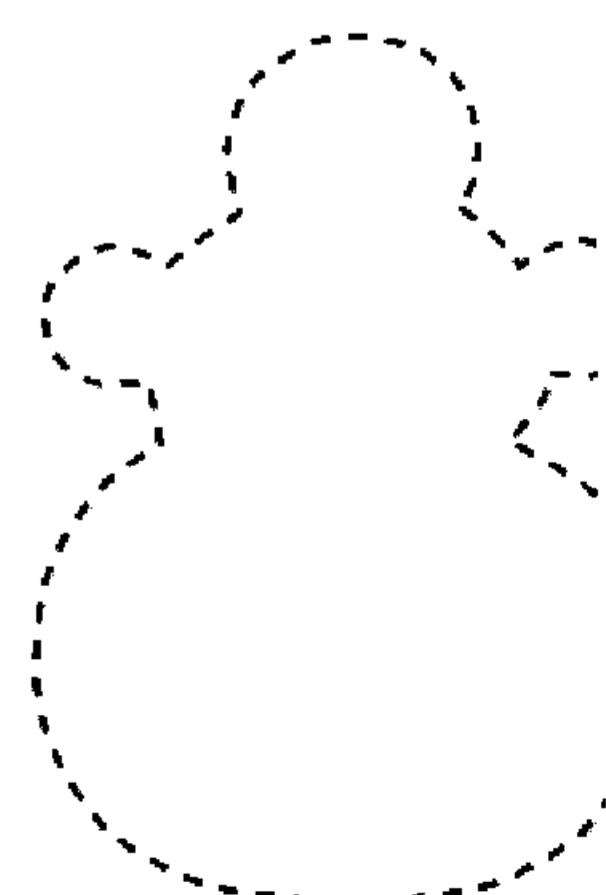
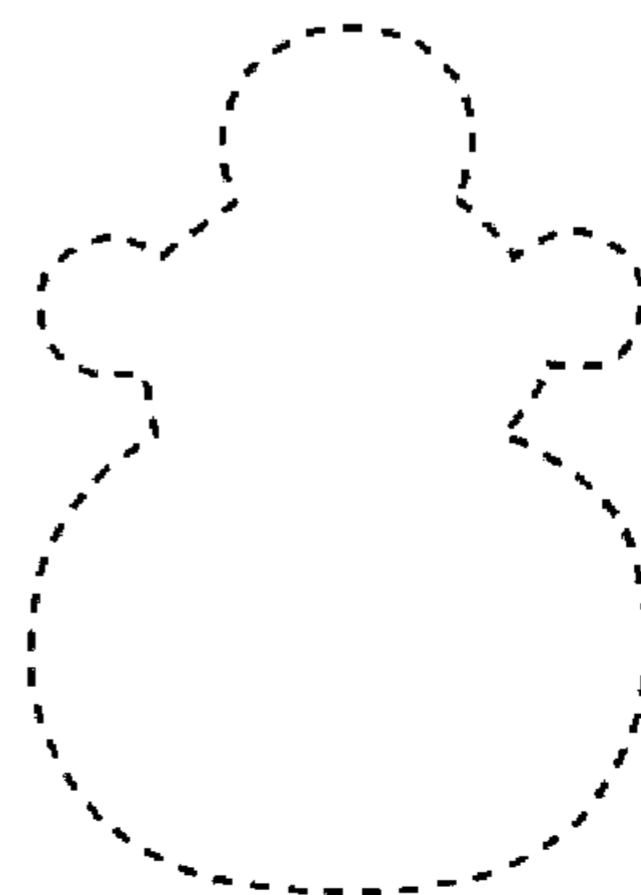
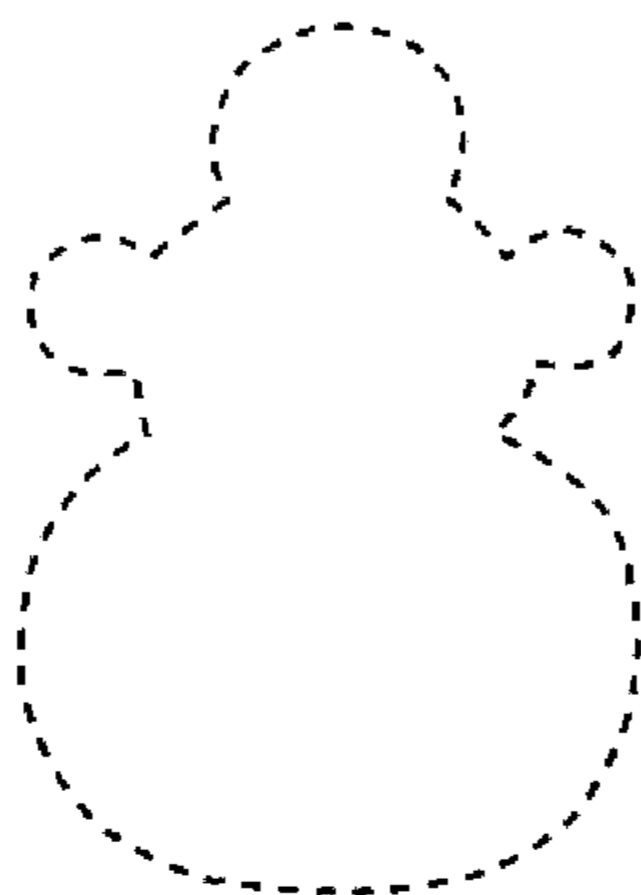
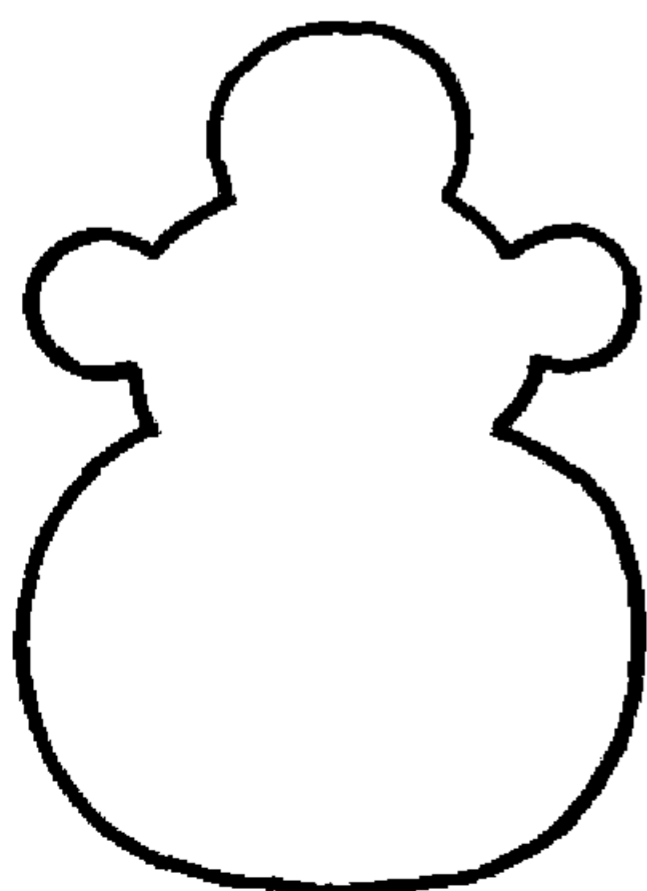
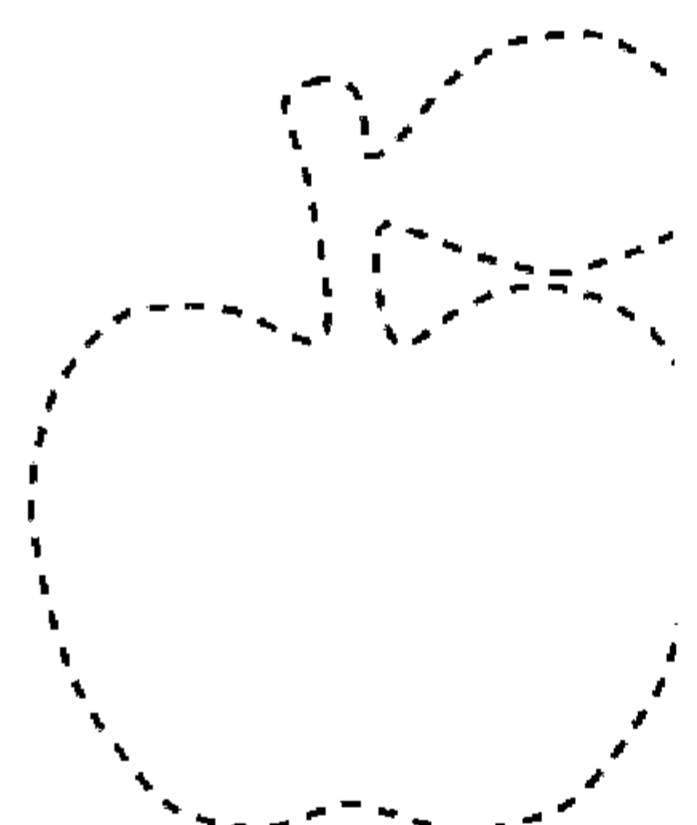
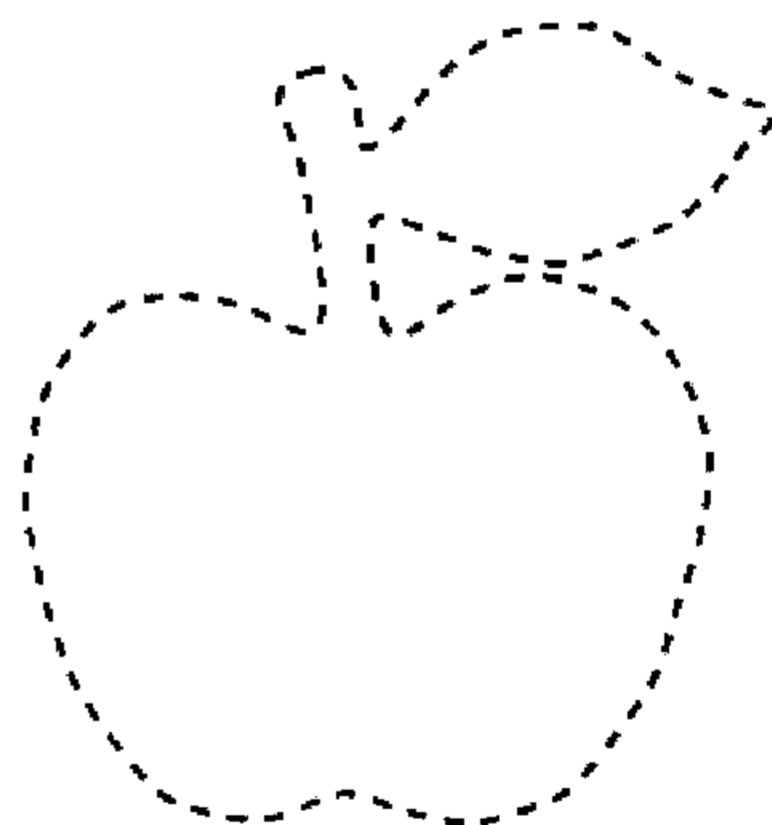
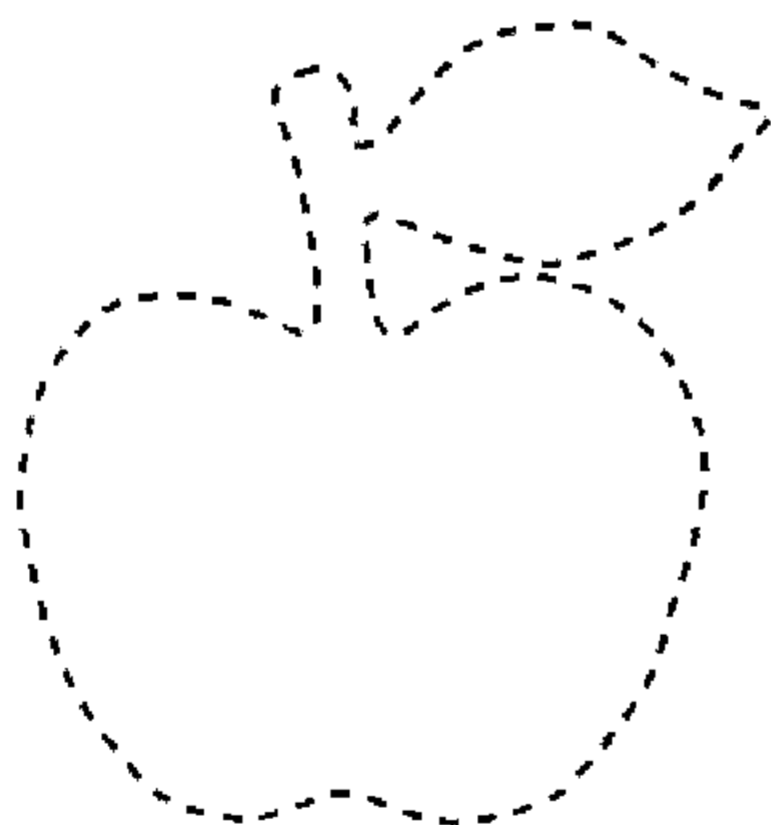
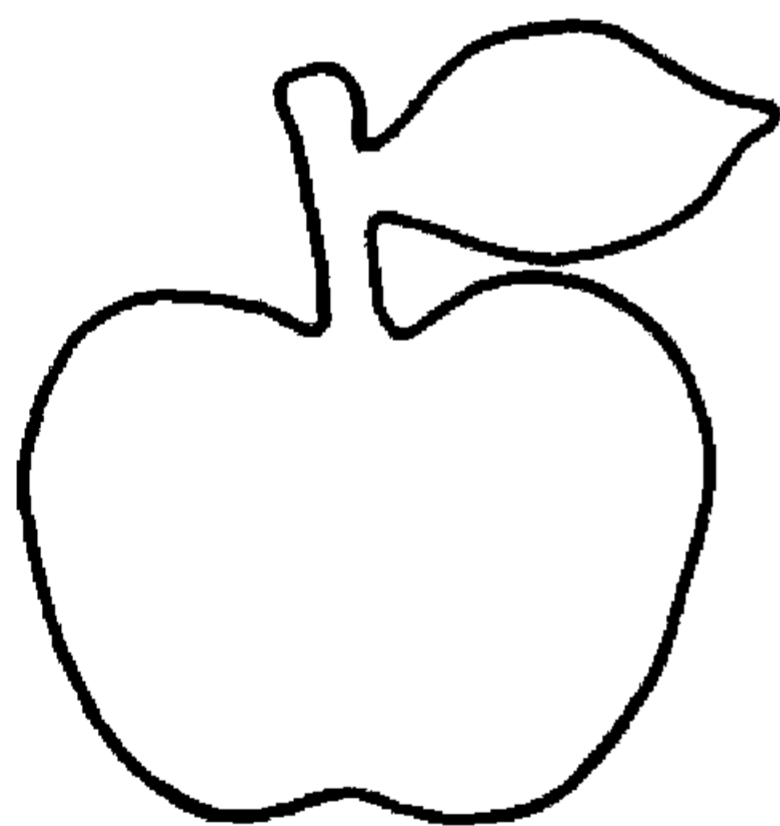
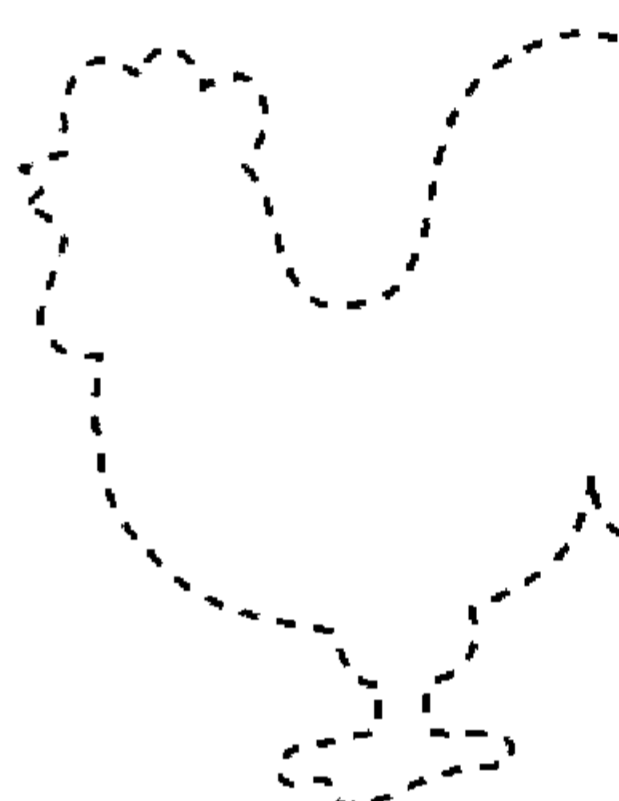
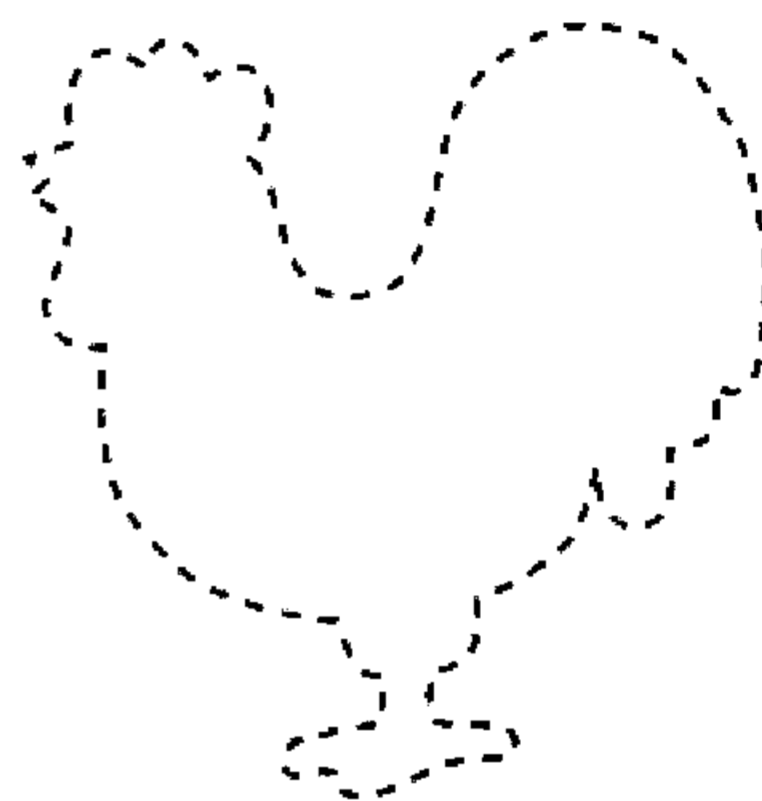
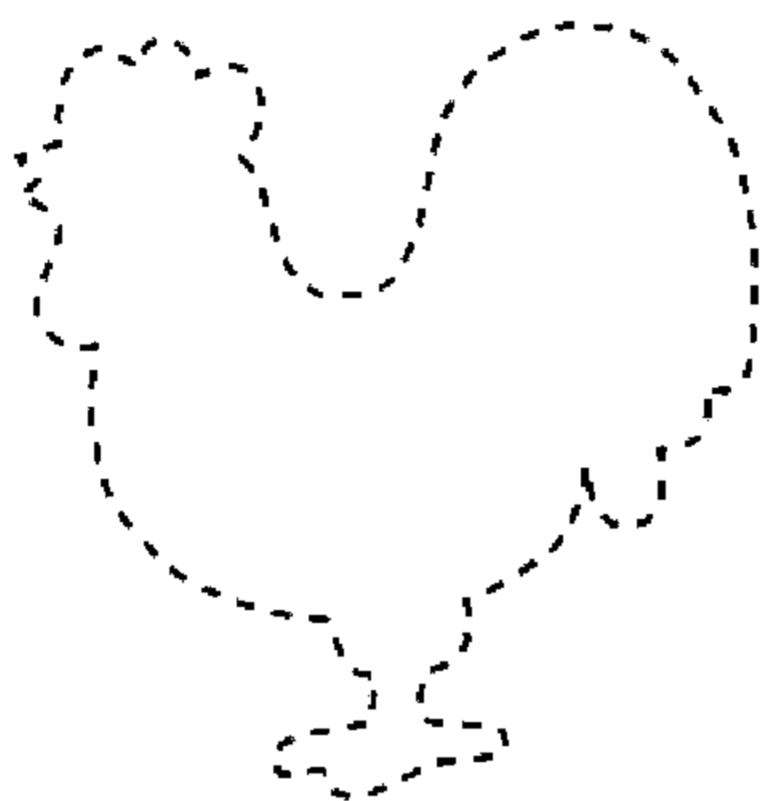
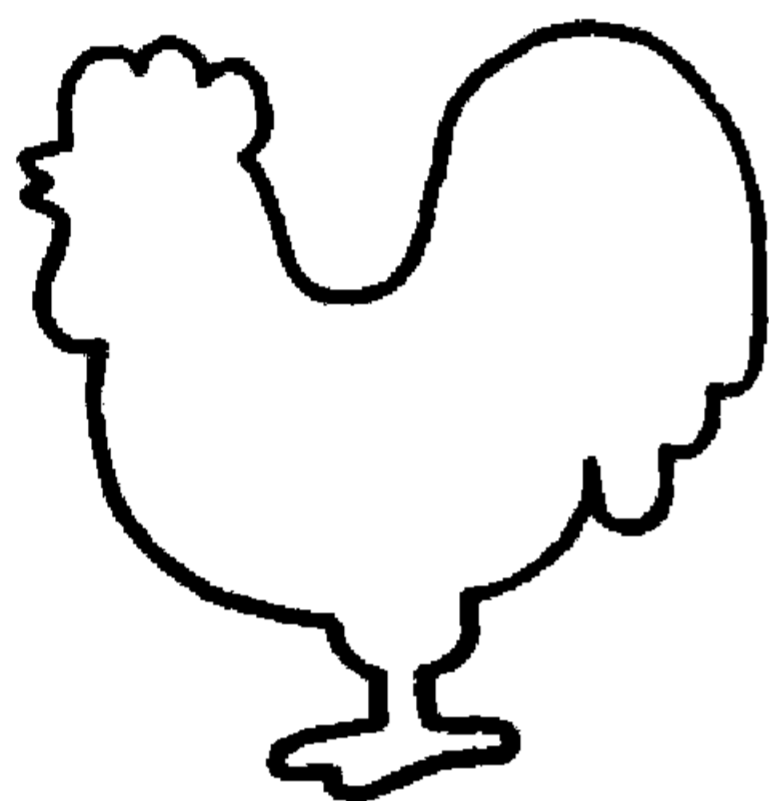
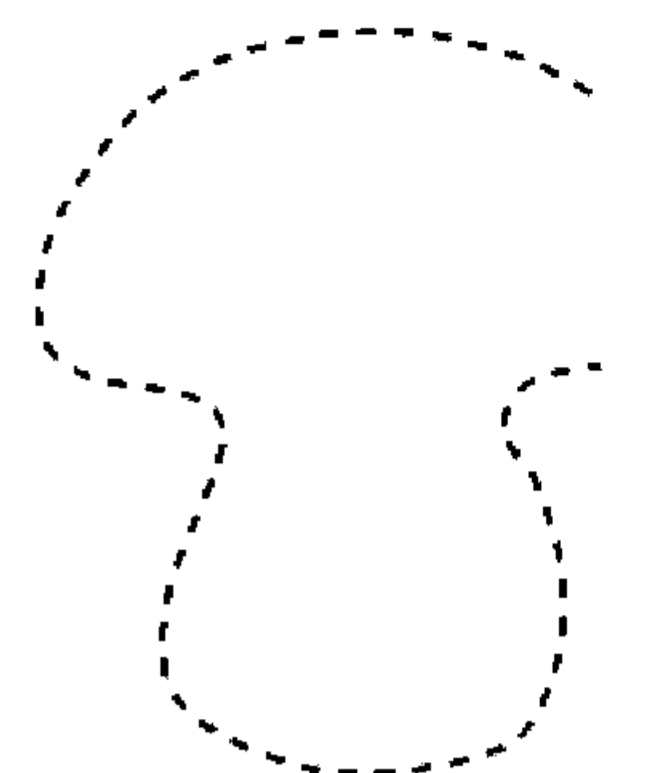
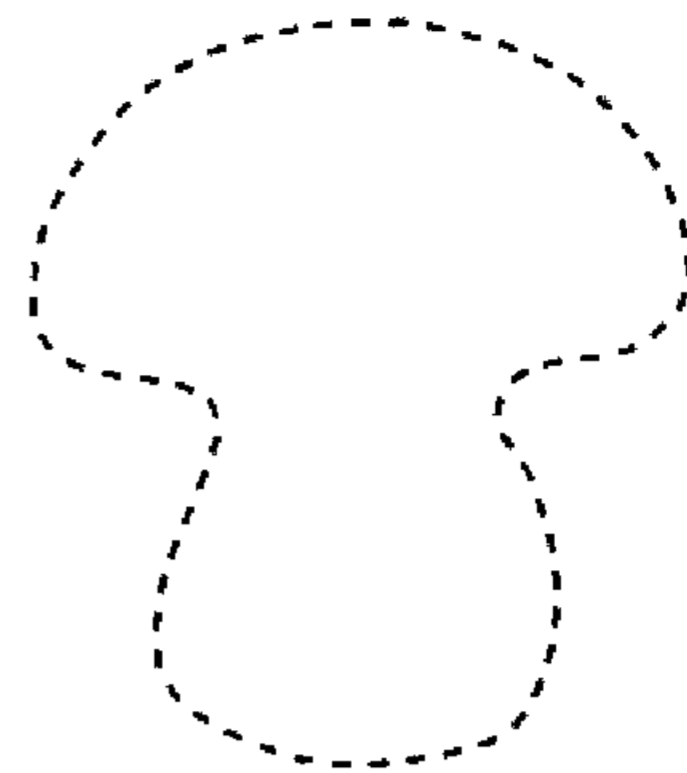
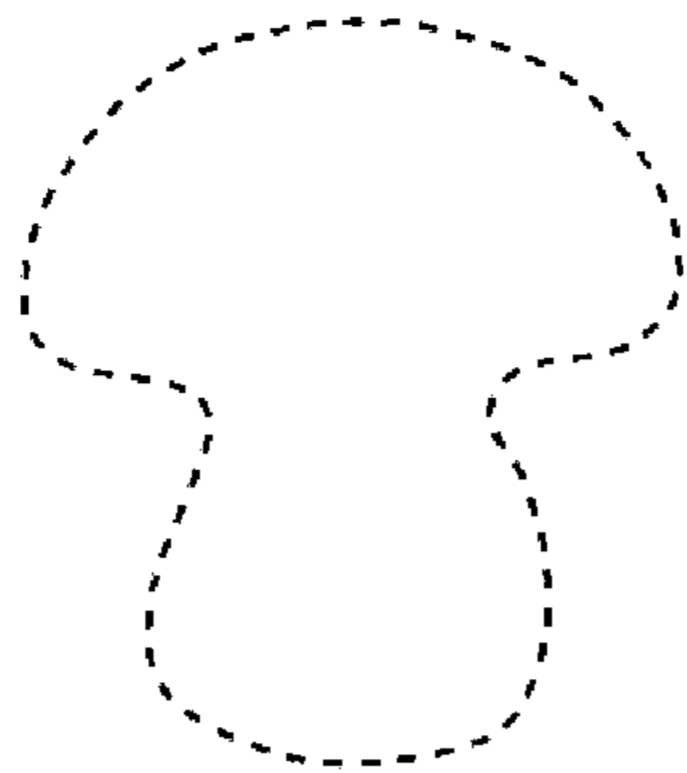
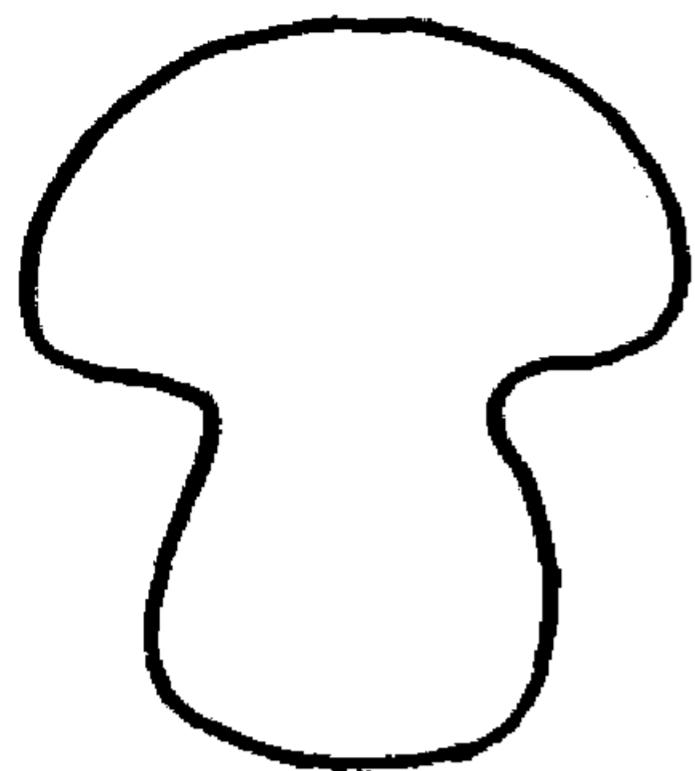

С

Слон

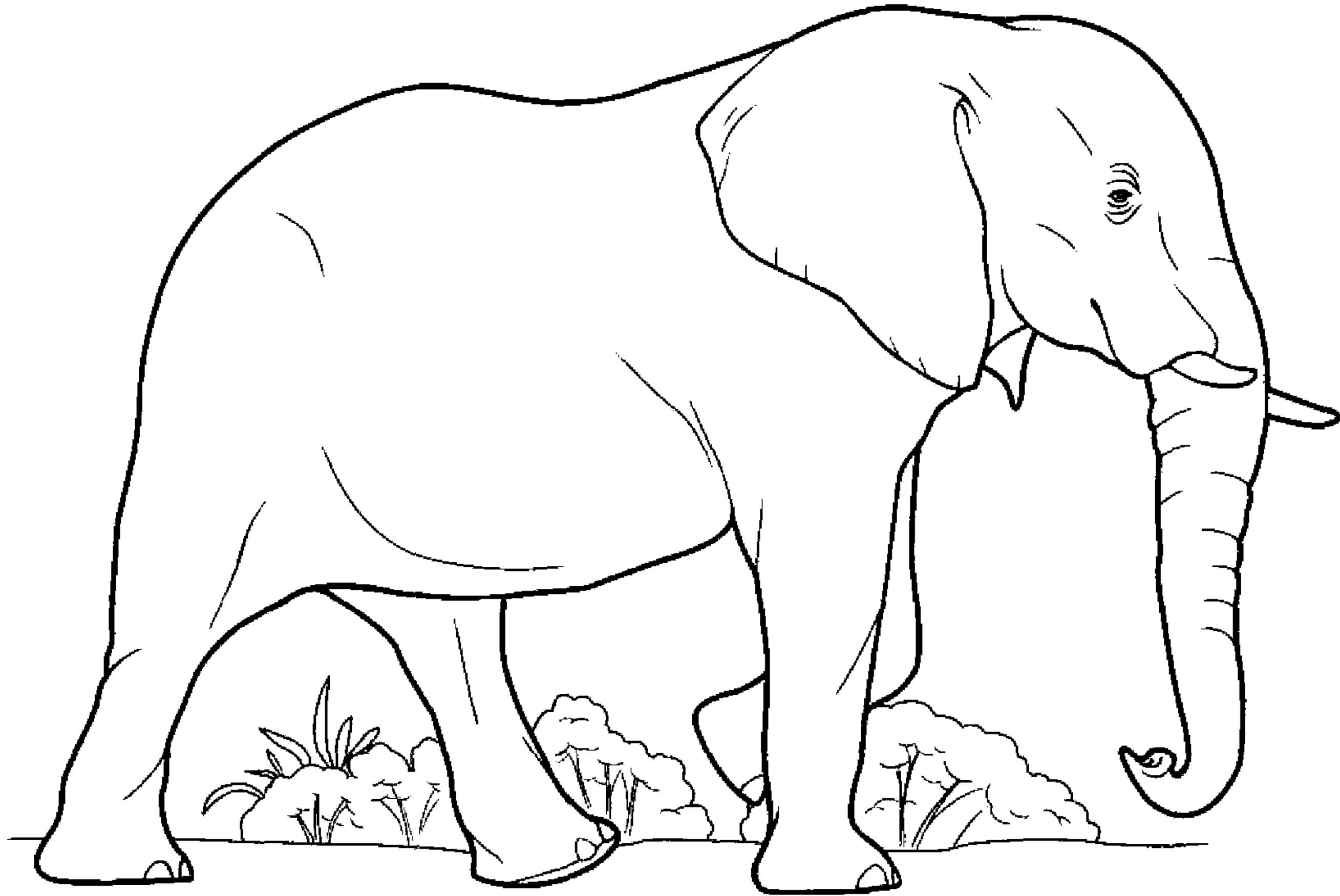
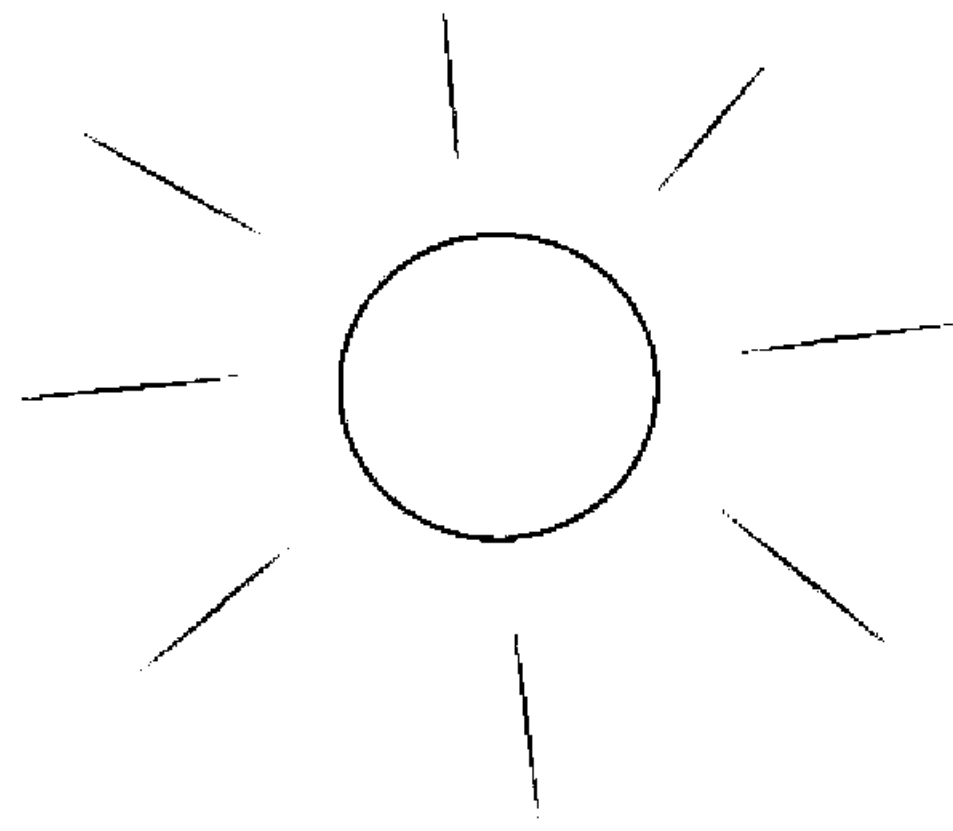

Three rows of handwriting practice lines. Each row consists of four horizontal lines. The first row shows a dashed uppercase letter 'C' with three numbered arrows indicating the stroke order: 1 (top curve), 2 (left curve), and 3 (bottom curve). To its right is another dashed 'C' for tracing. The second row shows a dashed lowercase letter 'c' with three numbered arrows indicating the stroke order: 1 (top curve), 2 (left curve), and 3 (bottom curve). To its right is another dashed 'c' for tracing. The third row shows two dashed uppercase 'C's for tracing without stroke order guides.

Дорисуй вторые половинки ковриков и раскрась их.

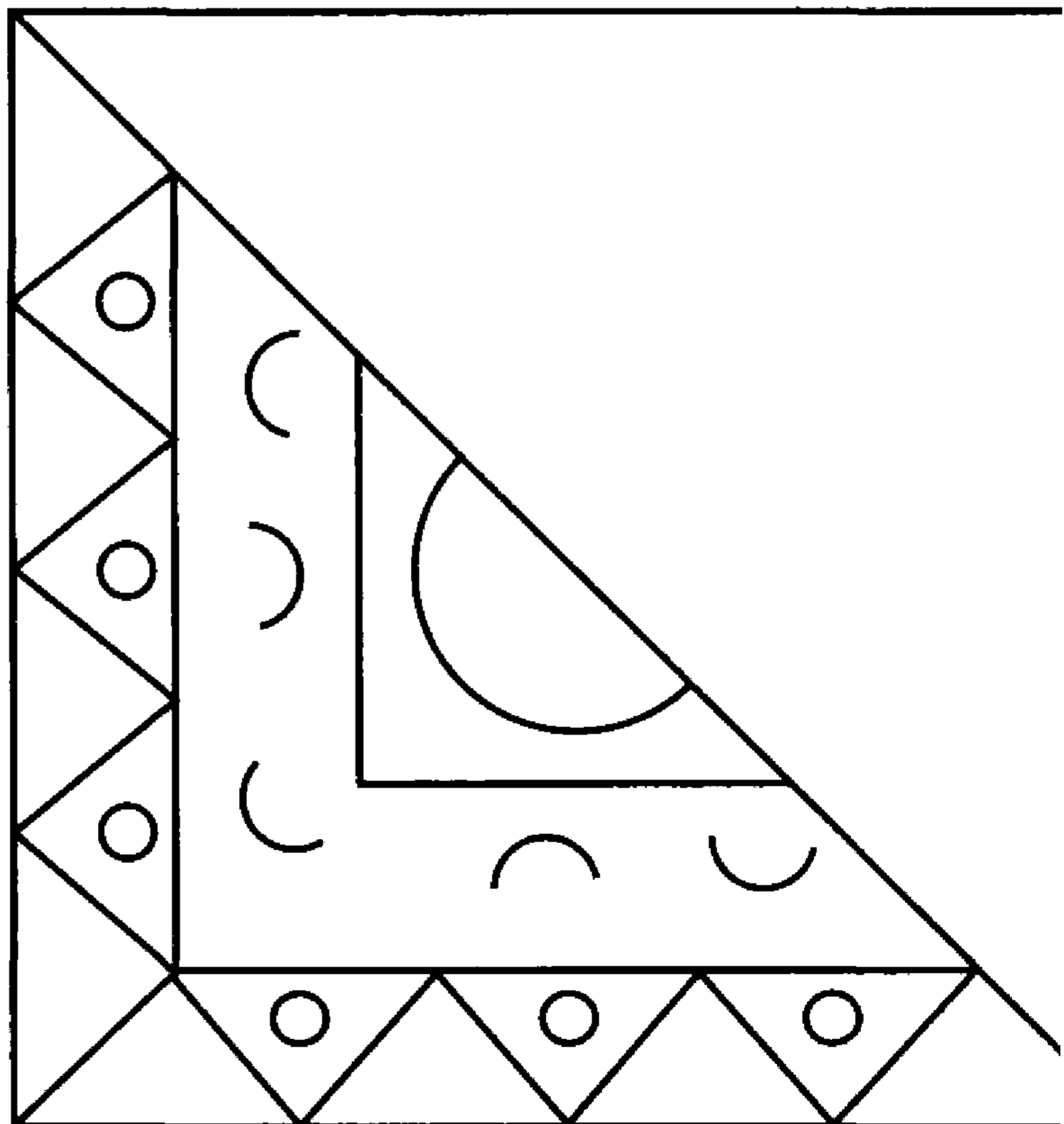
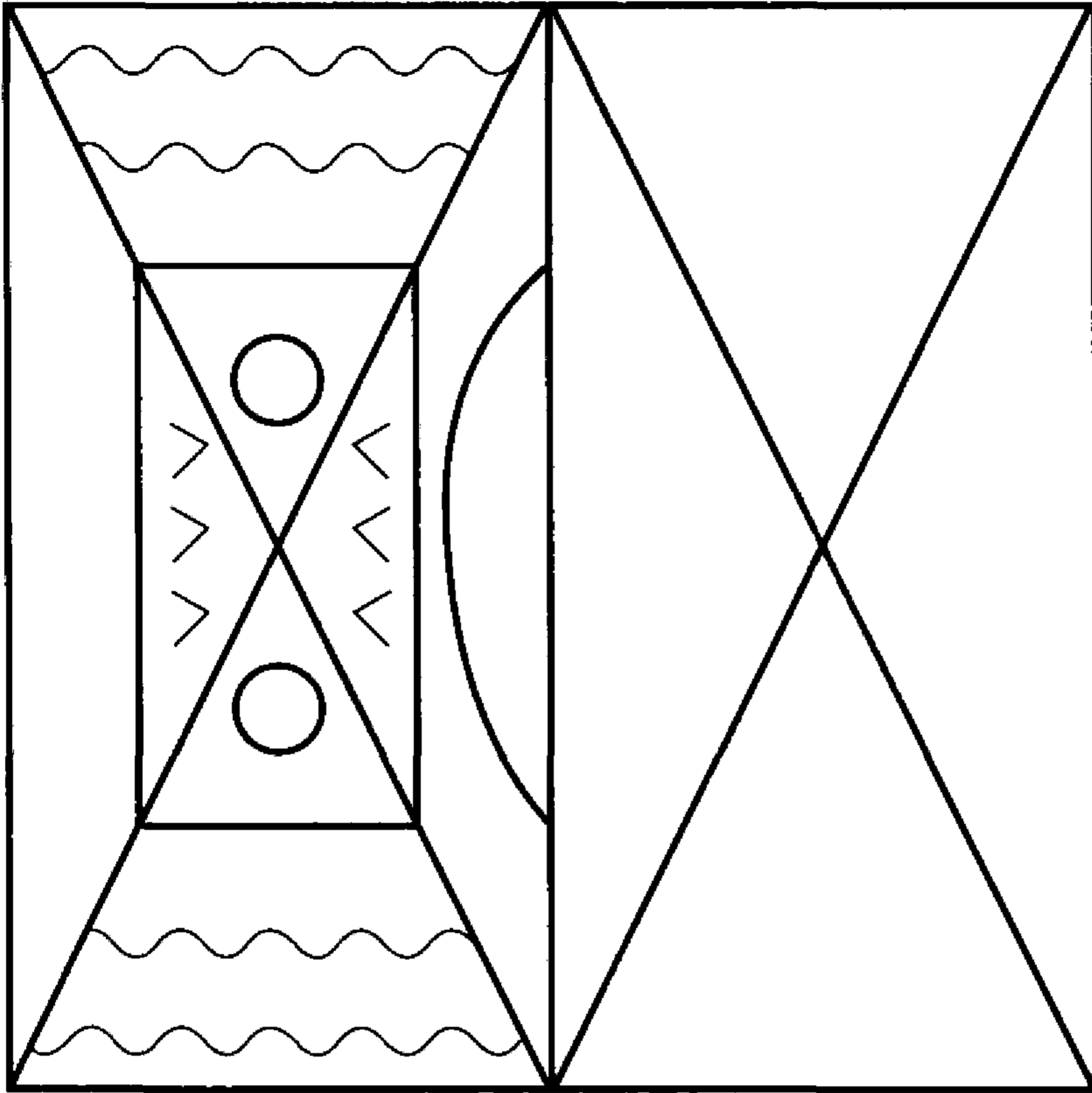

T

Тигр



2

1

2

1

1

2

1

2

Выполни штриховку этих предметов параллельными линиями, оставляя окошечки незаштрихованными. Раскрась картинки.

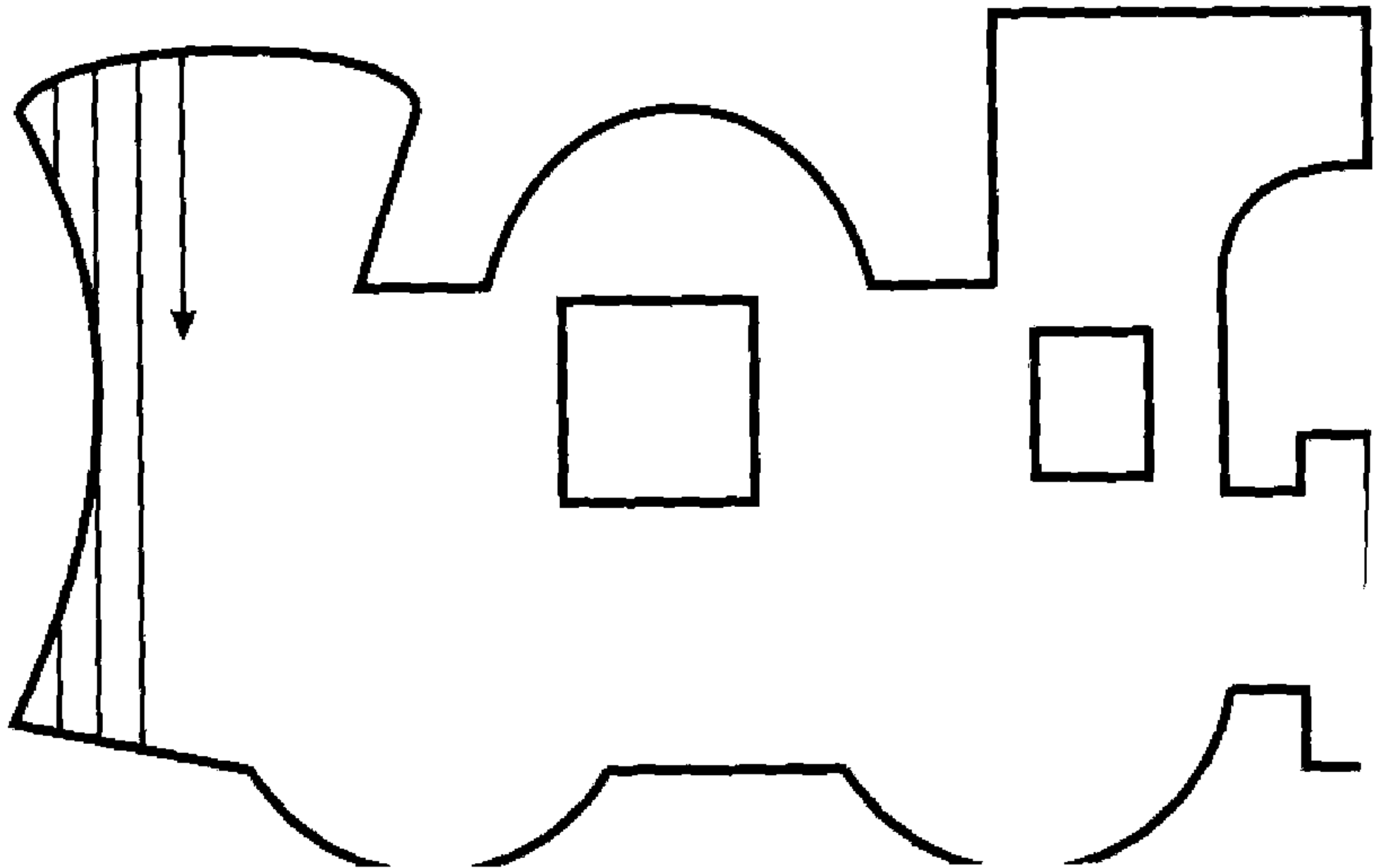
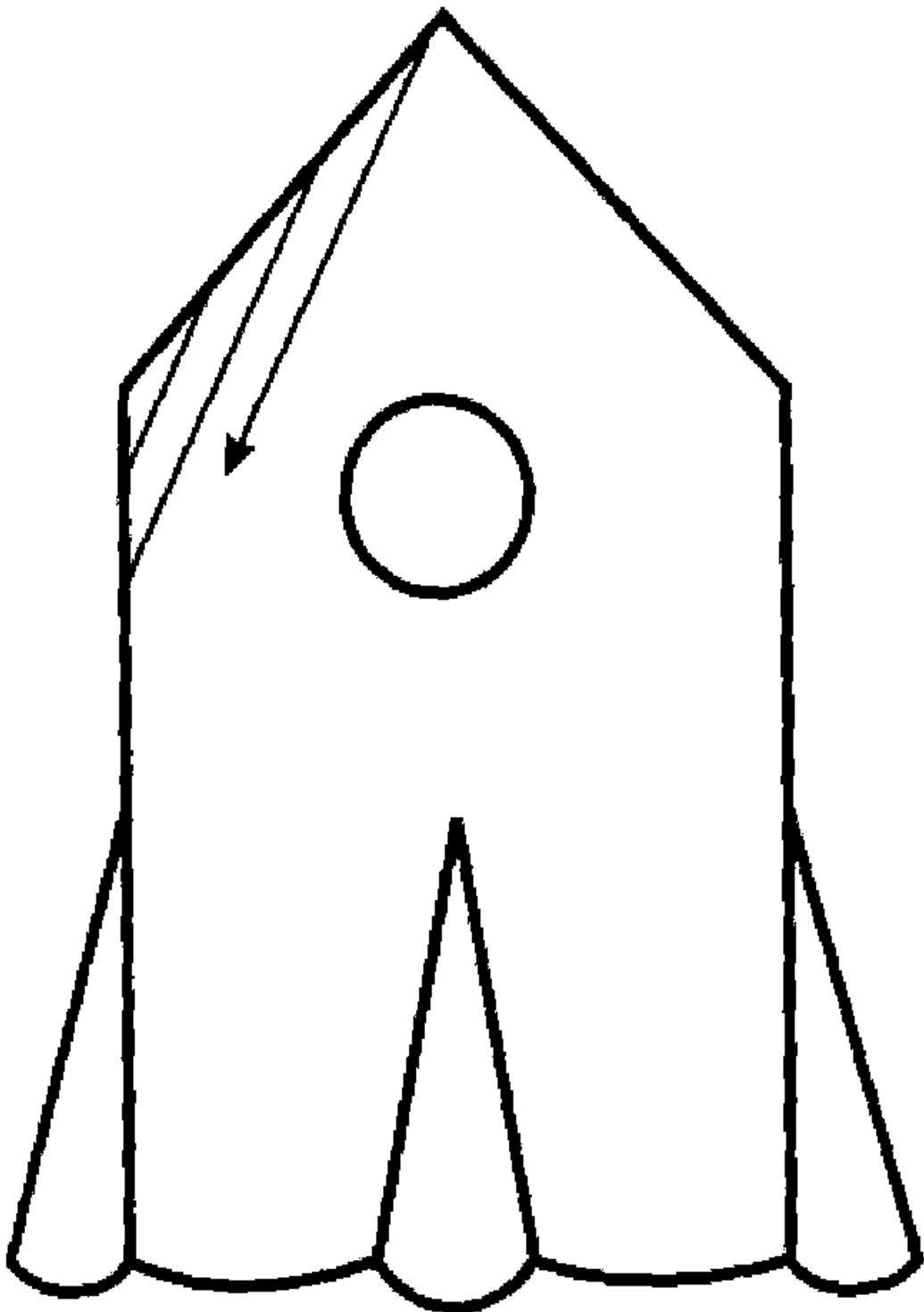
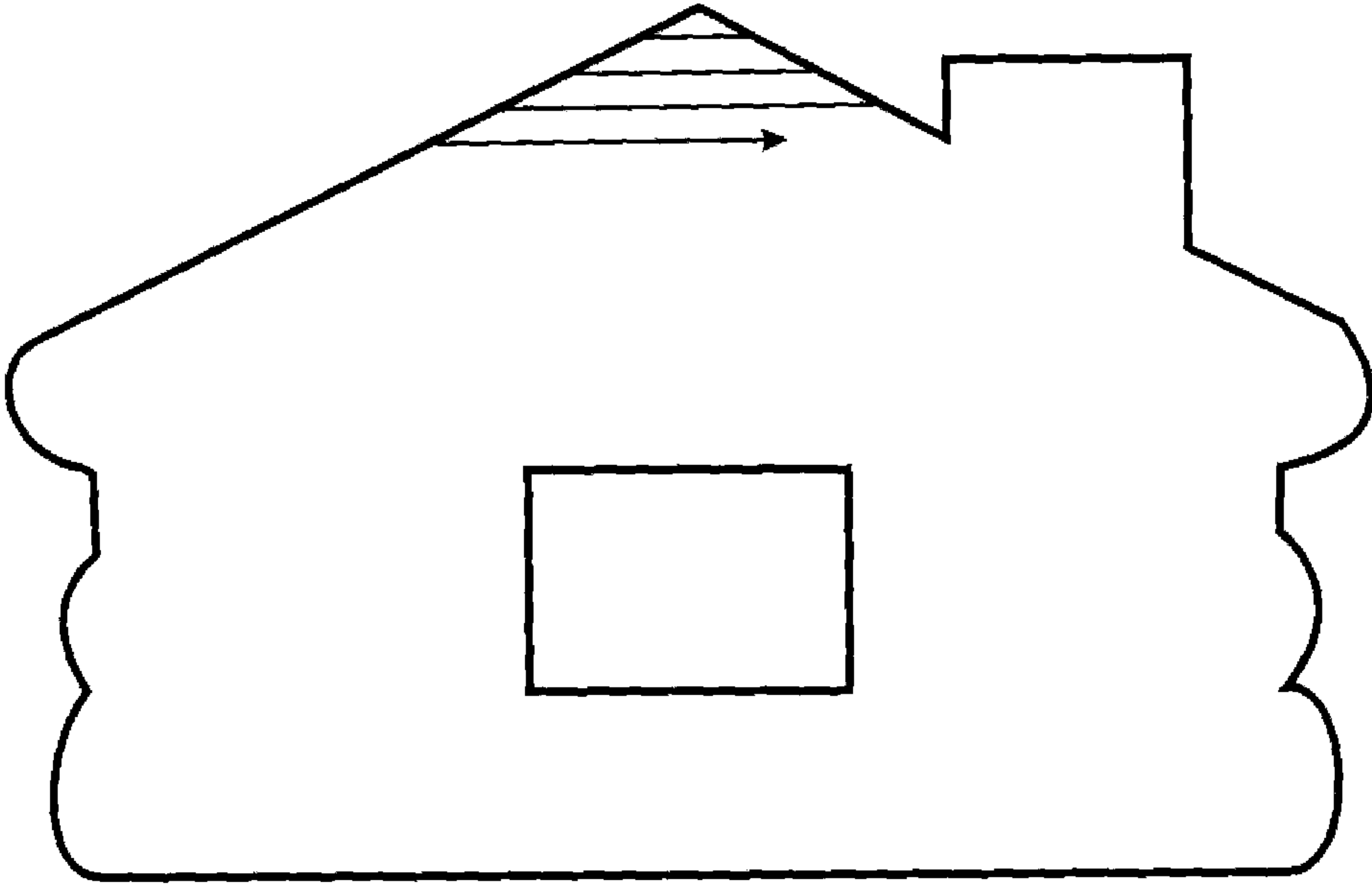

у

Утка

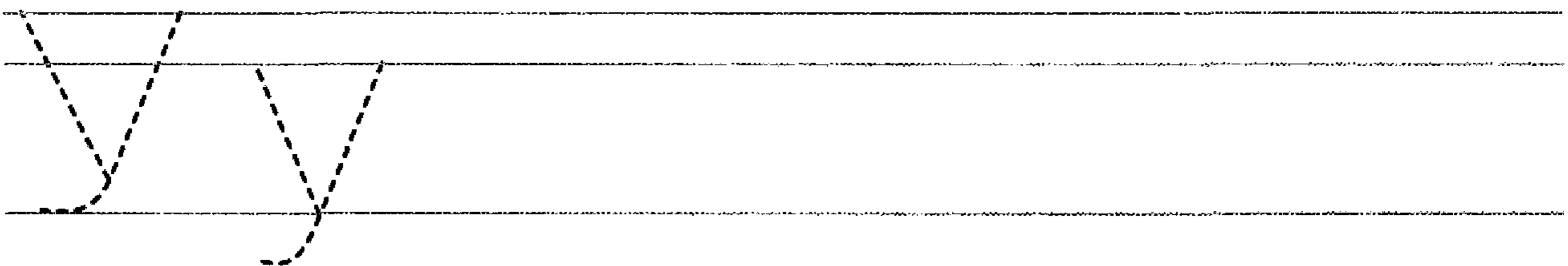
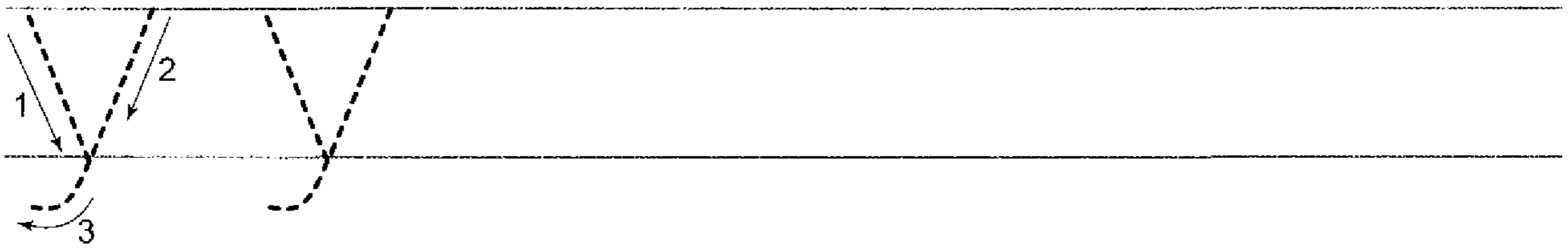
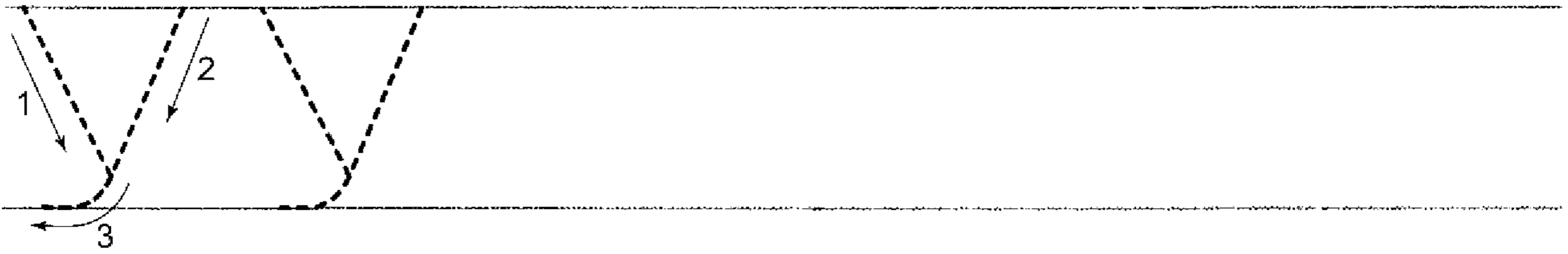
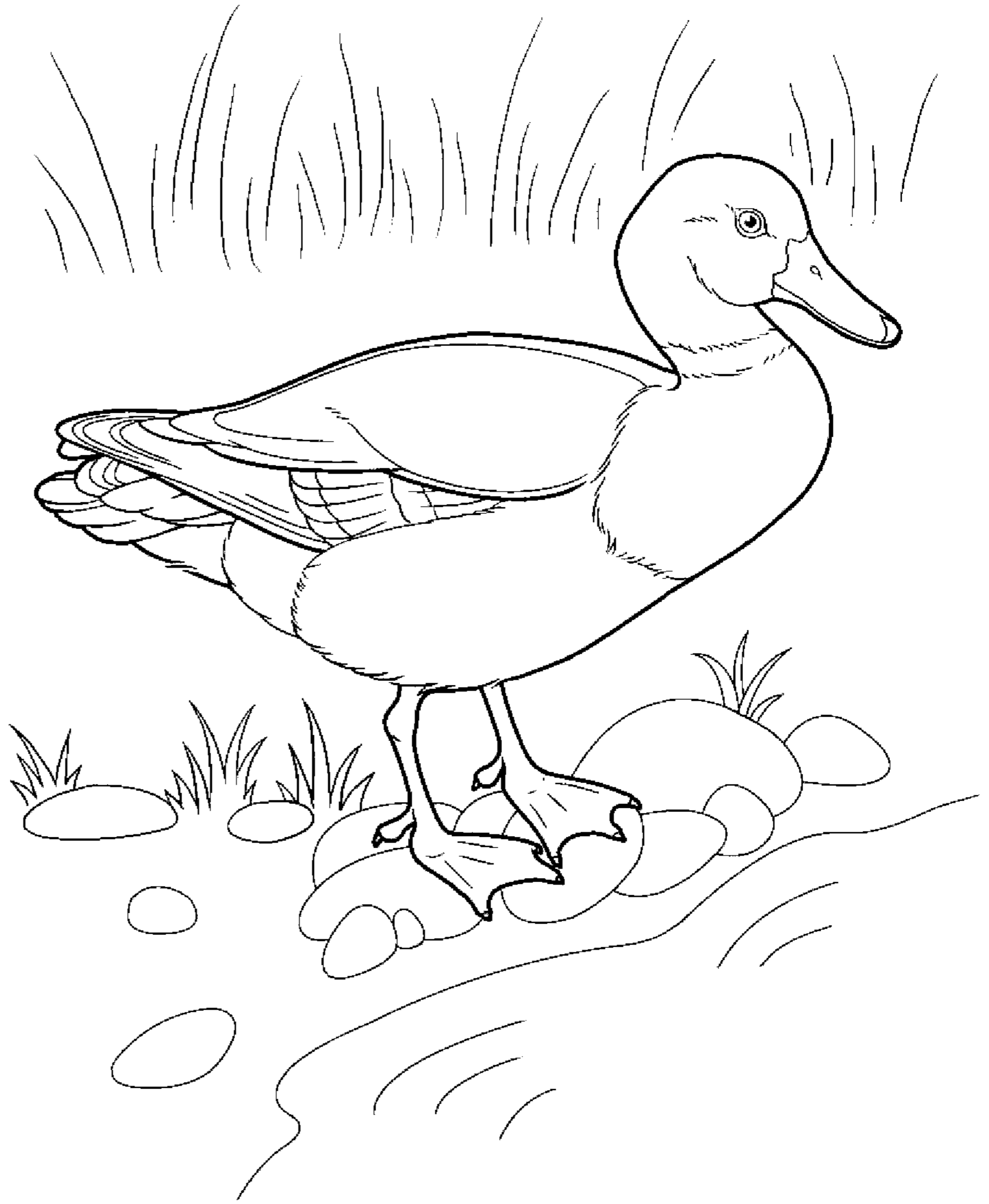

Обведи рисунки точно по пунктирной линии, не отрывая карандаш от бумаги.

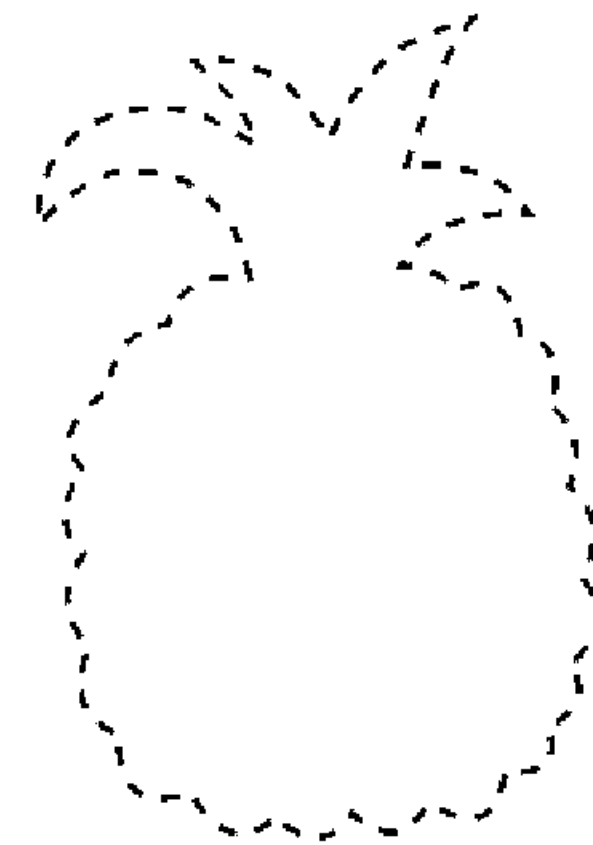
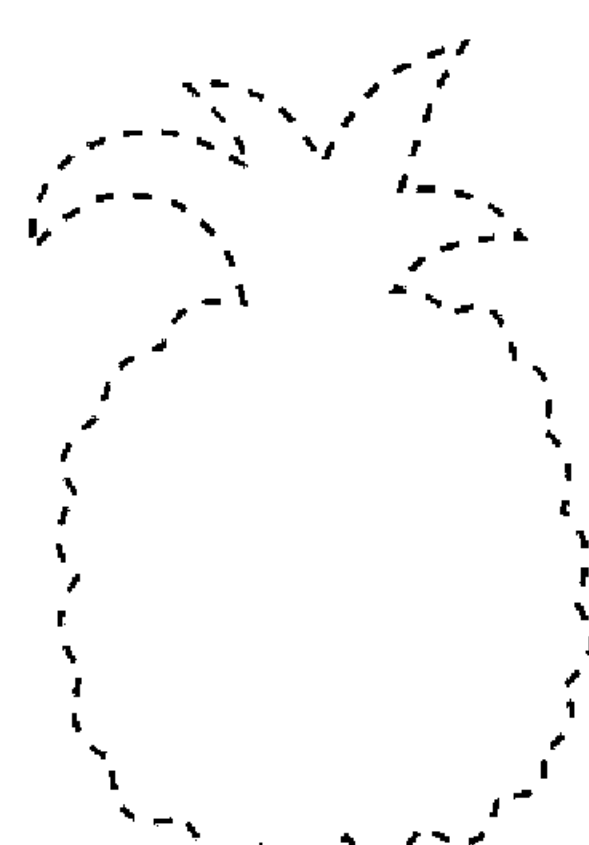
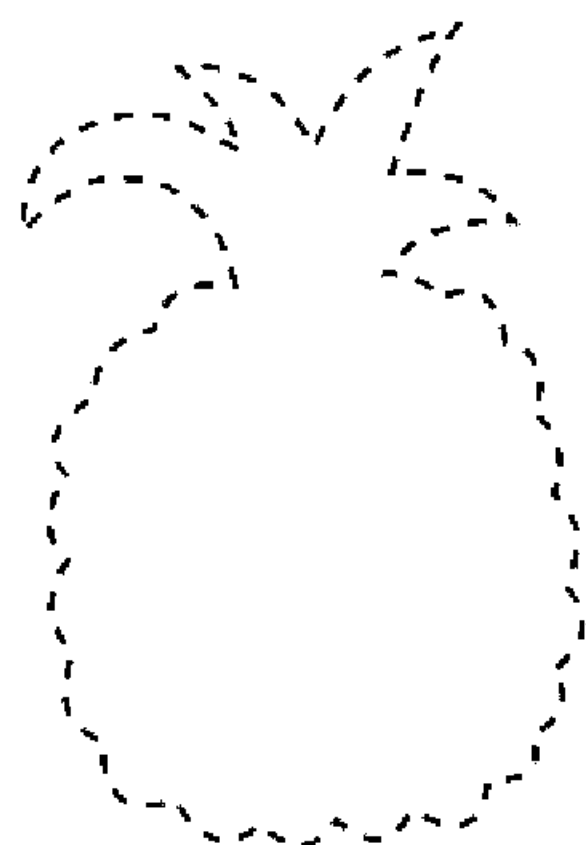
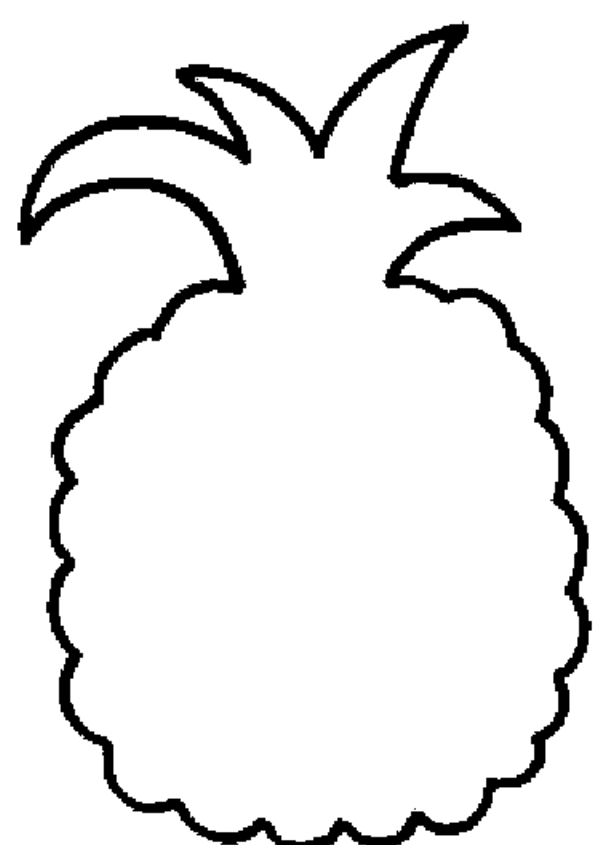
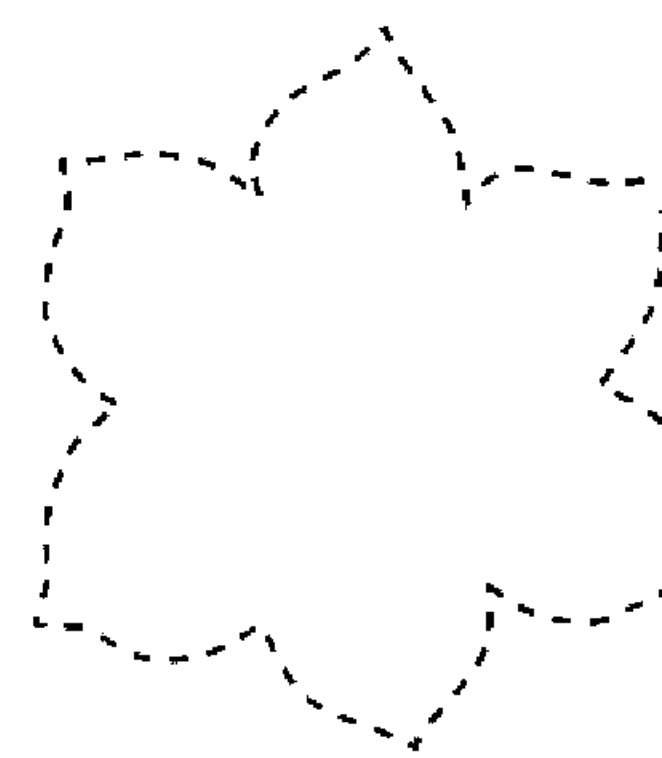
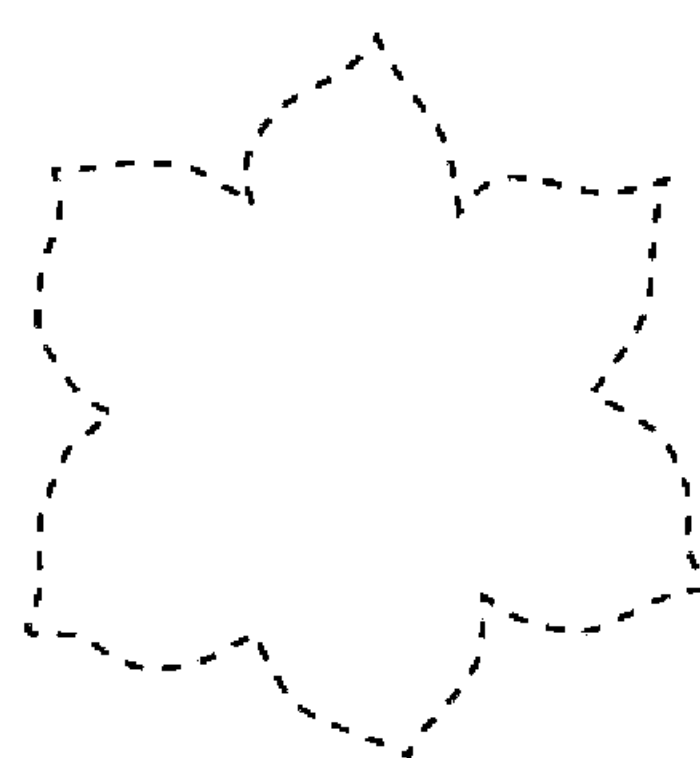
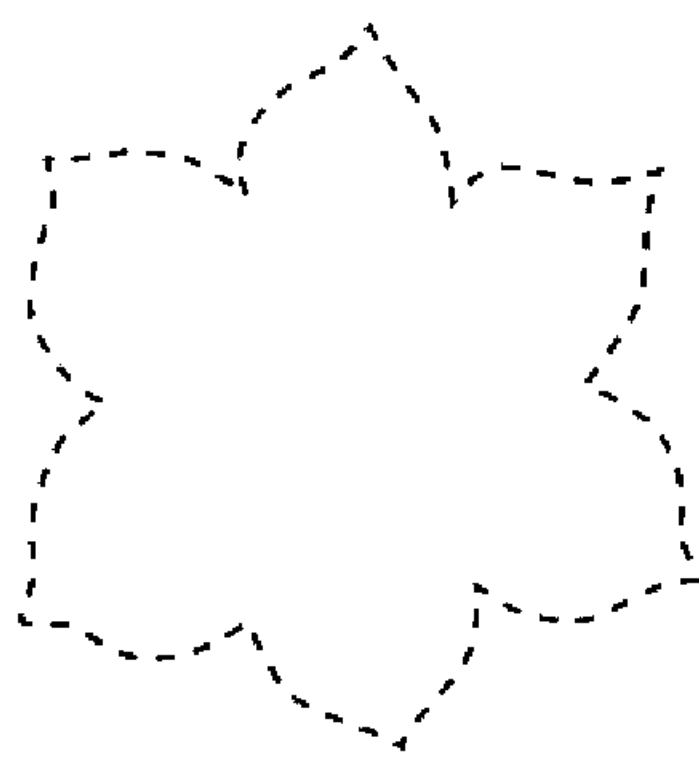
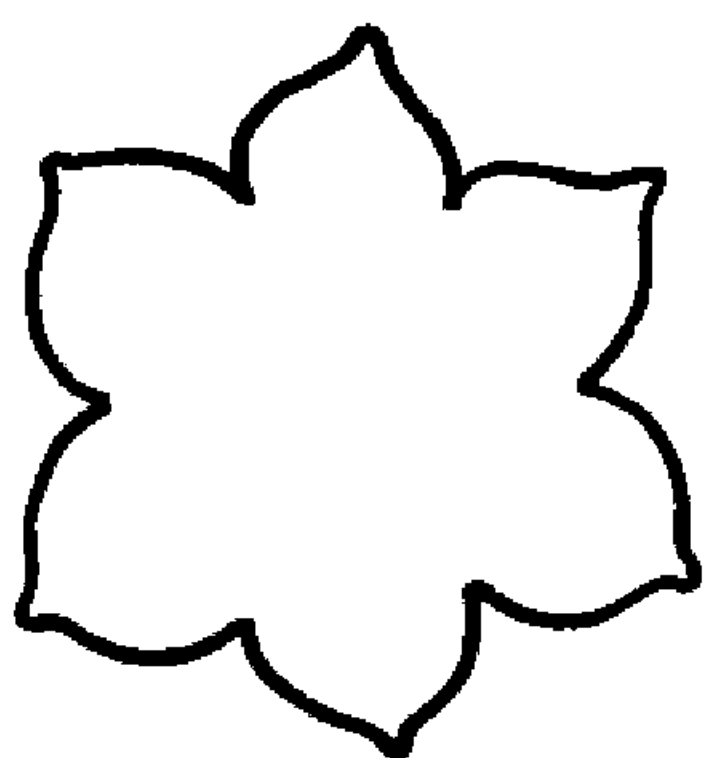
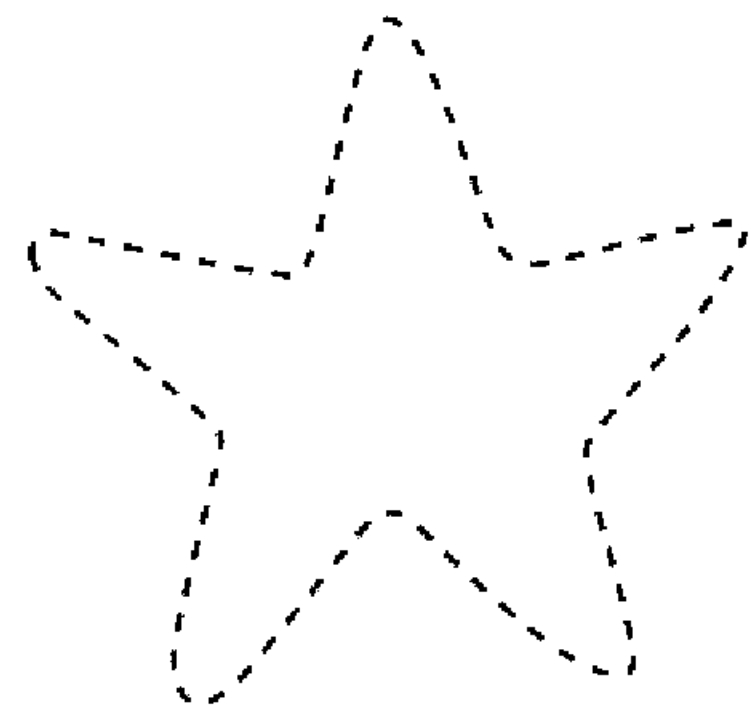
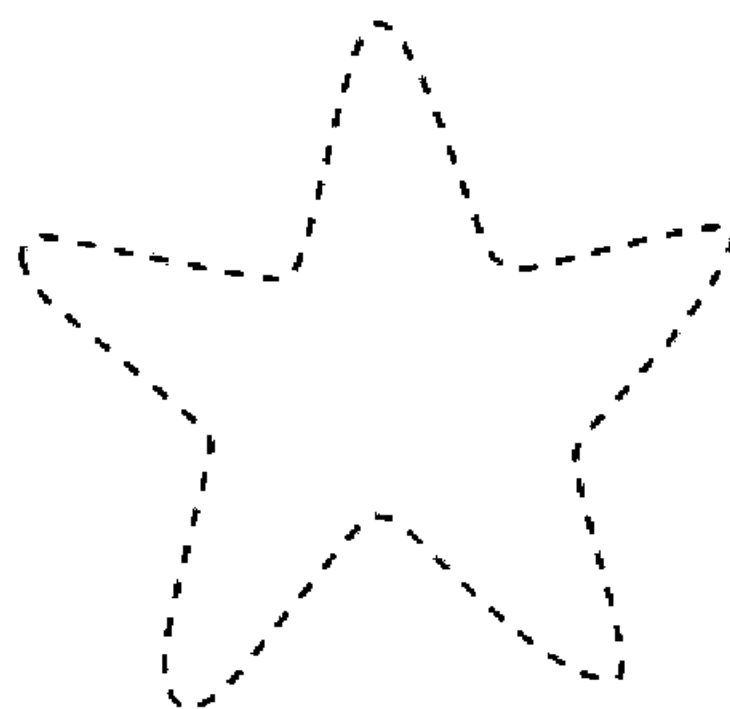
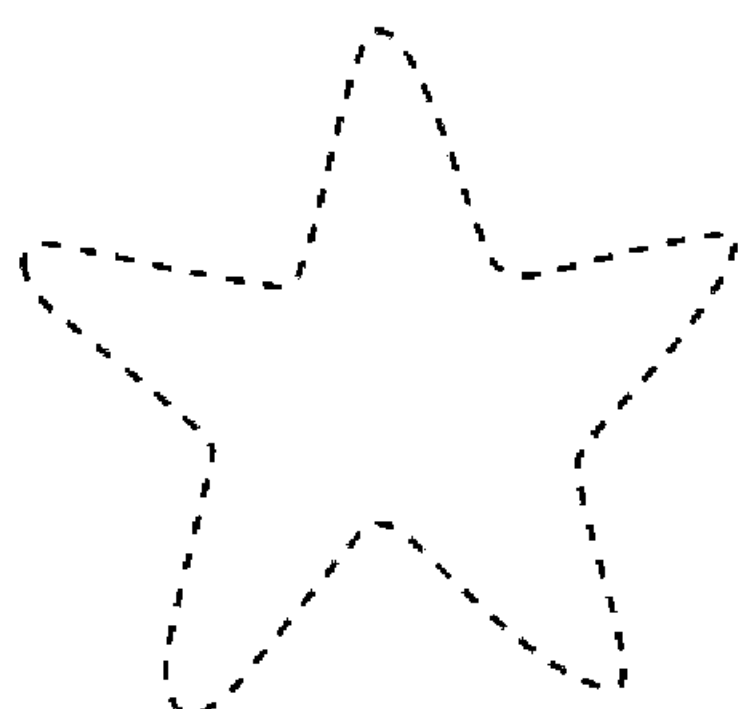
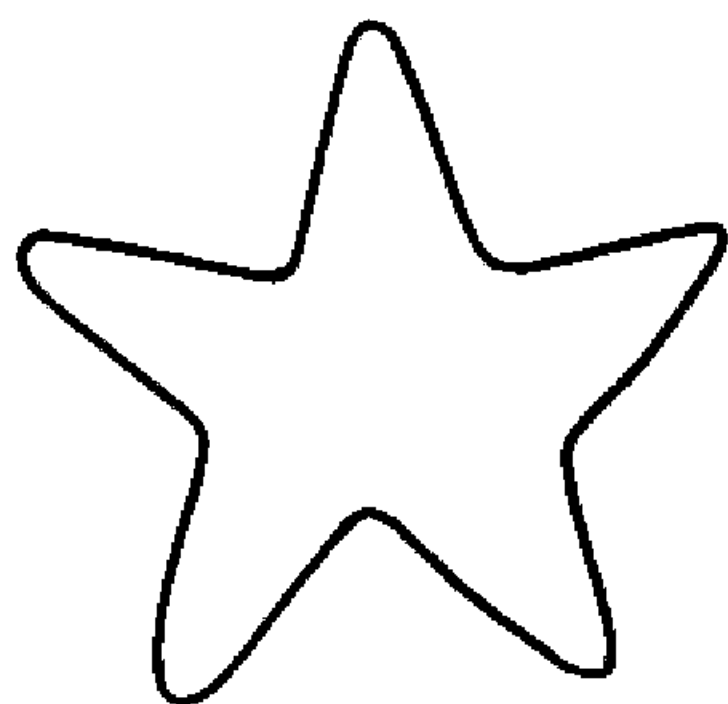
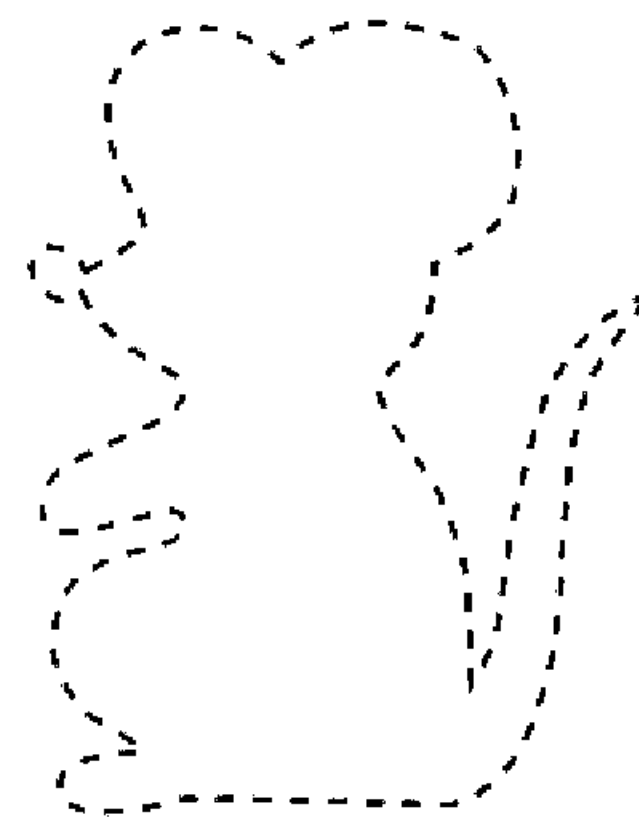
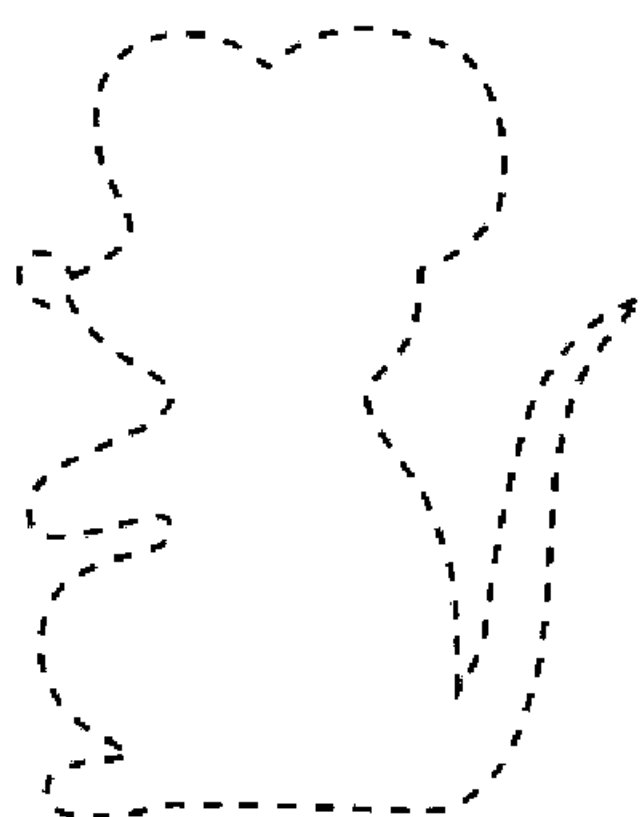

Ф

Фламинго

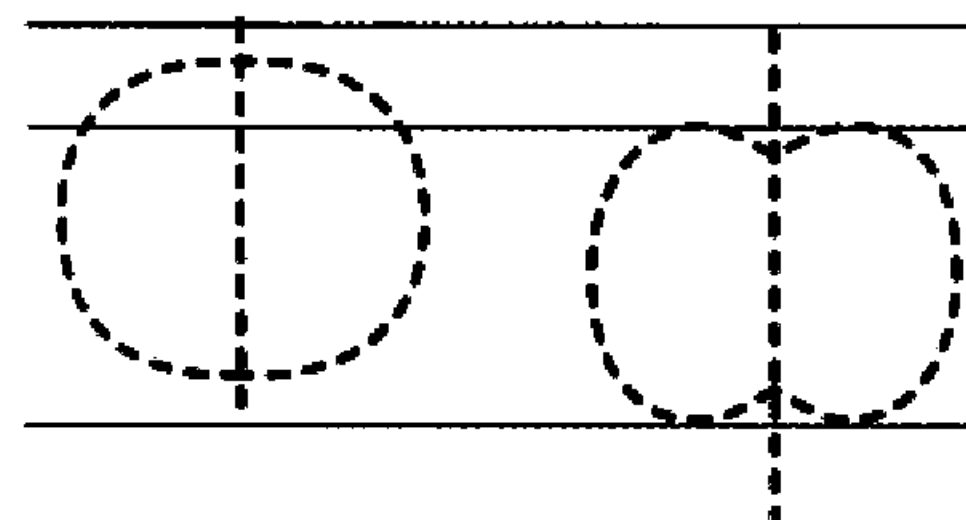
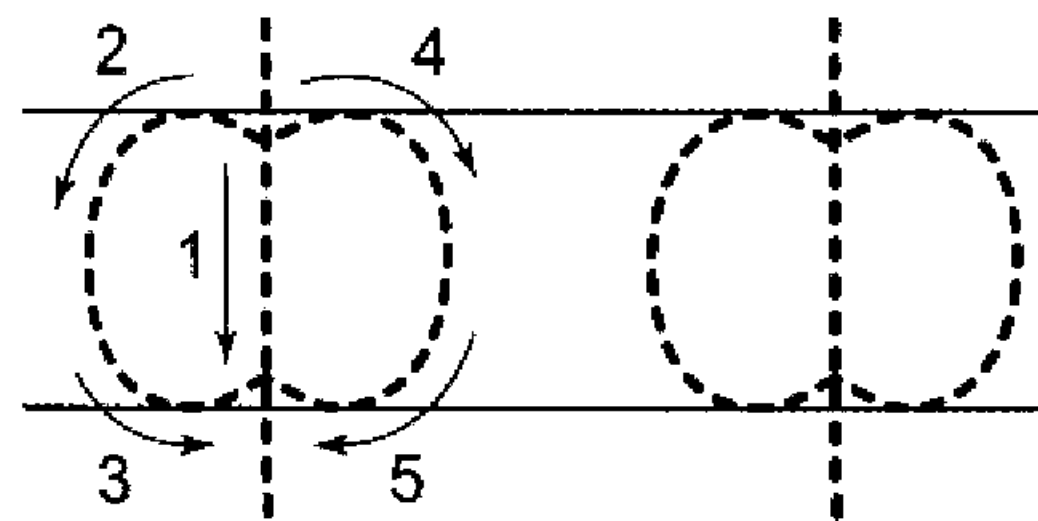
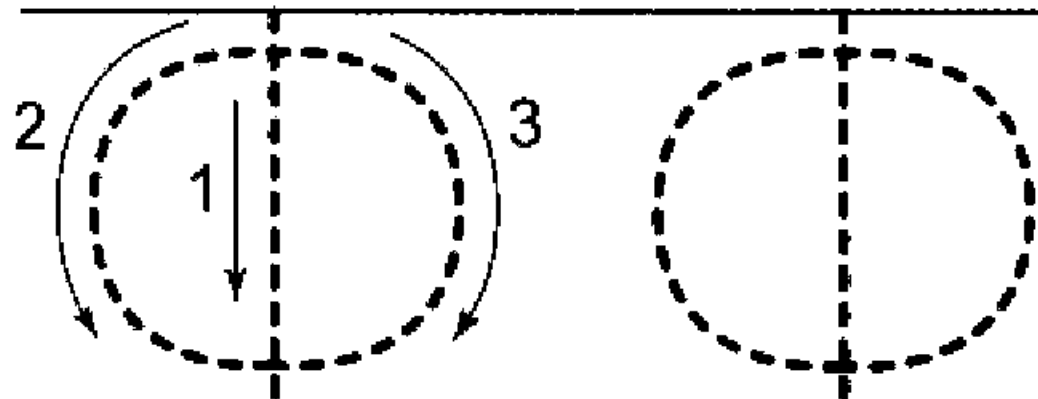
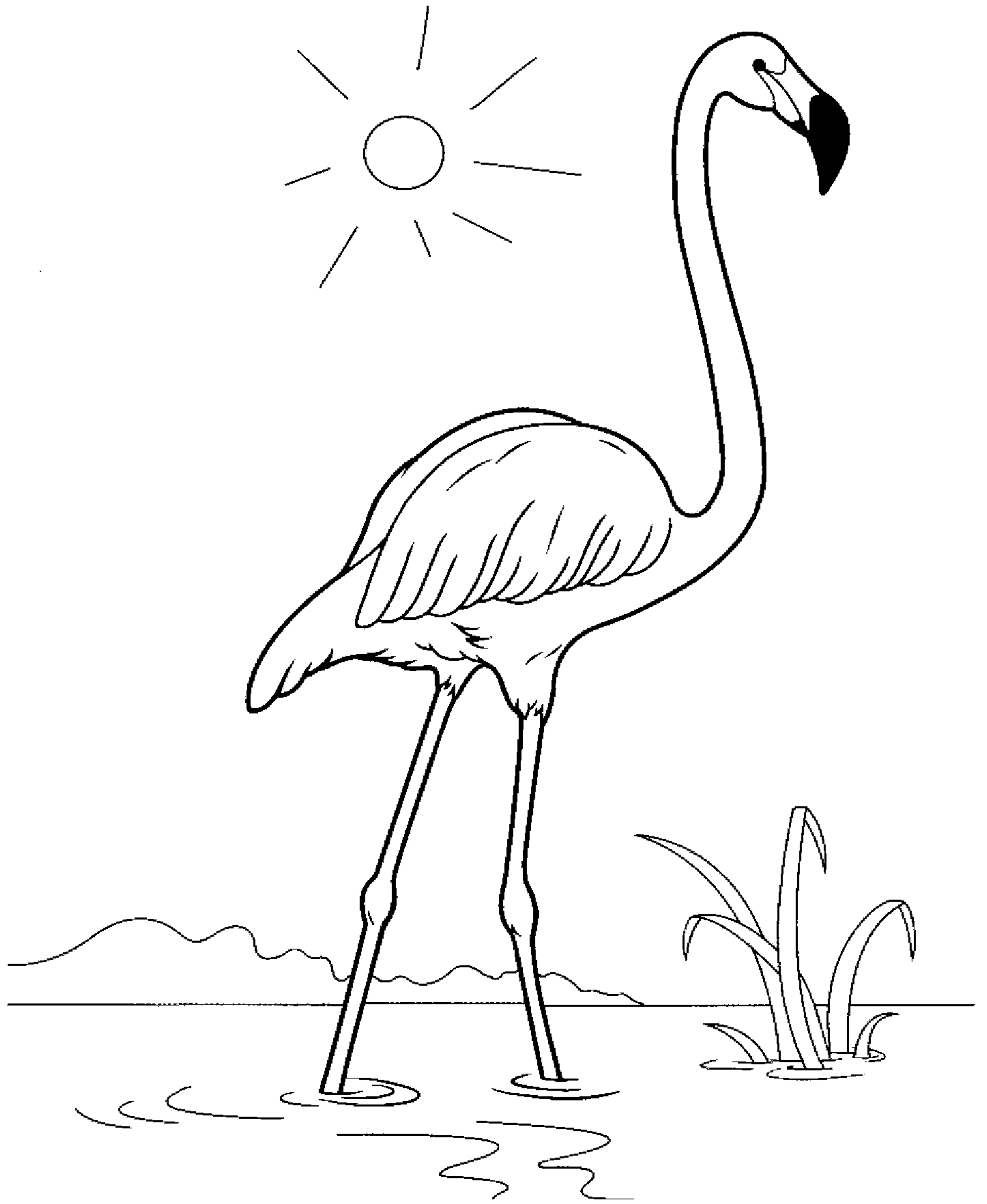

Проведи карандашом точно по линиям, постарайся не отрывать карандаш от бумаги. Раскрась картинки.

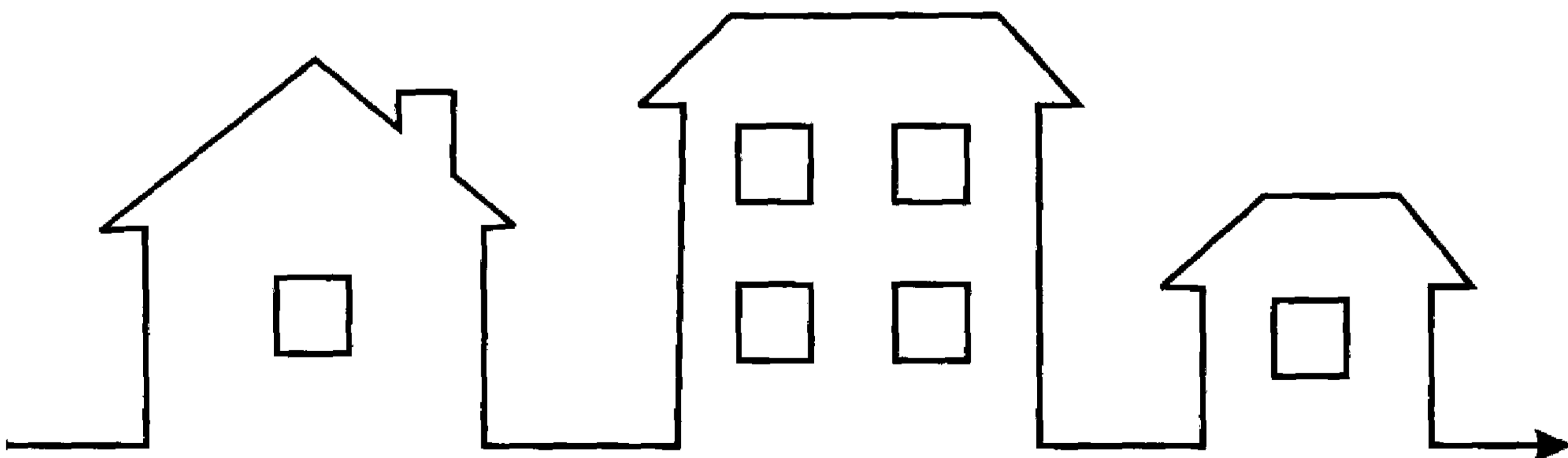
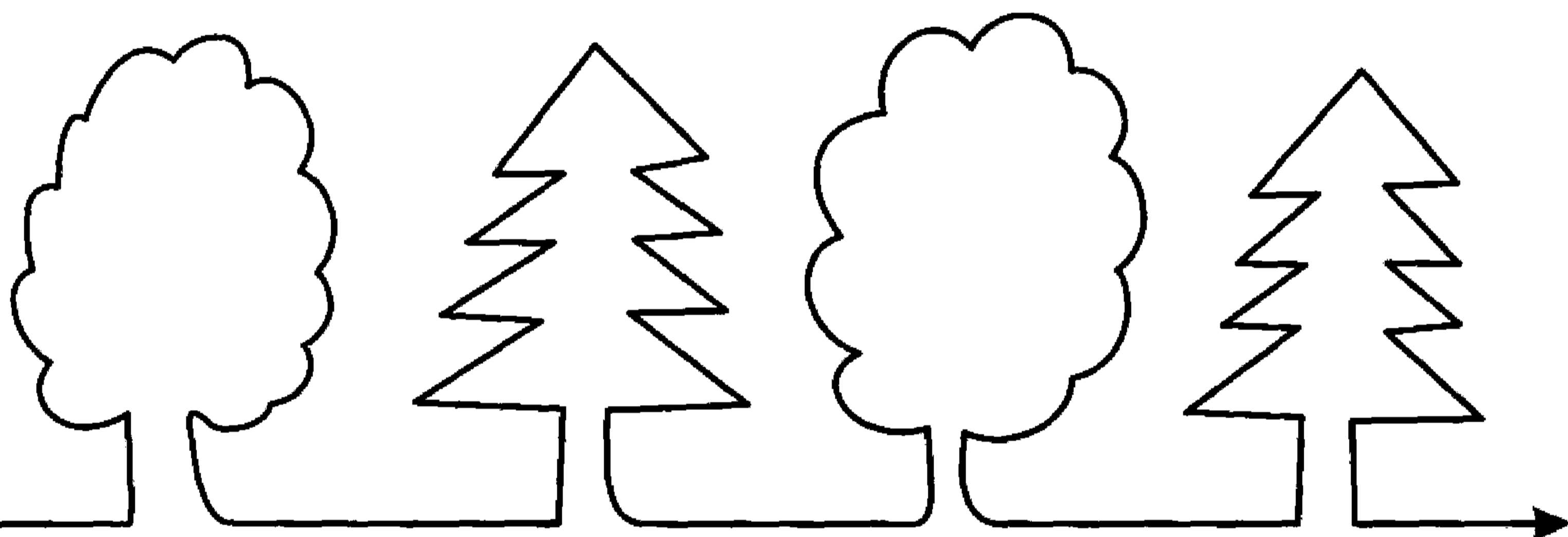
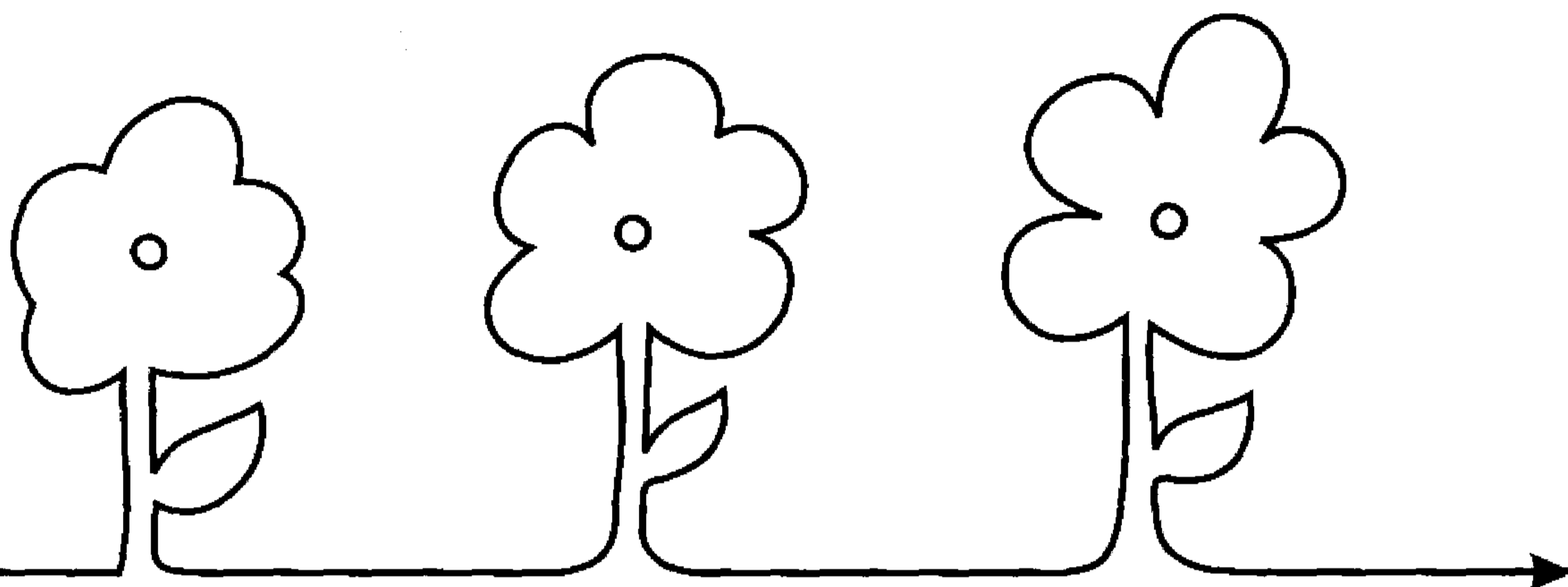

X

Хамелеон

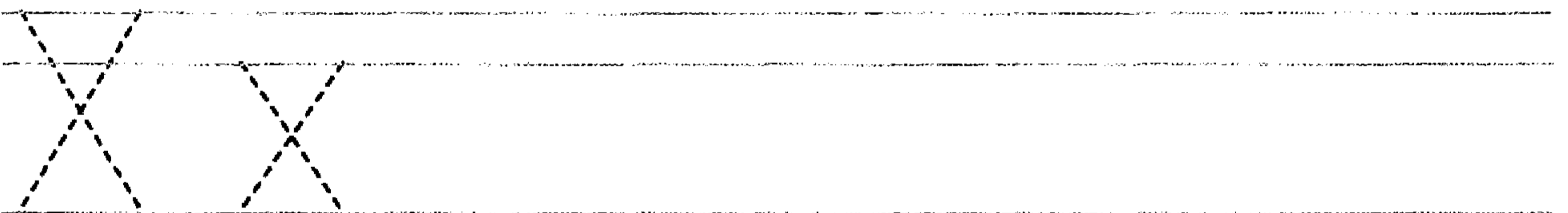
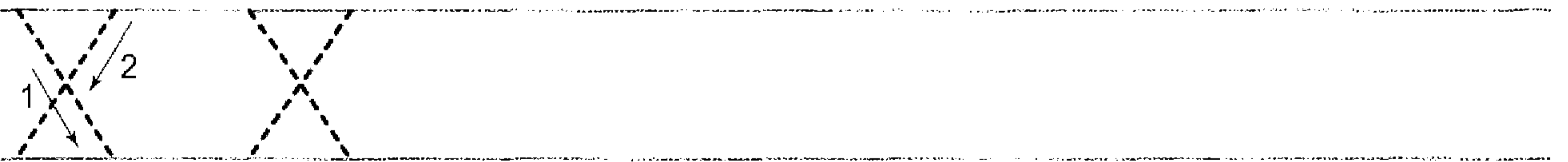
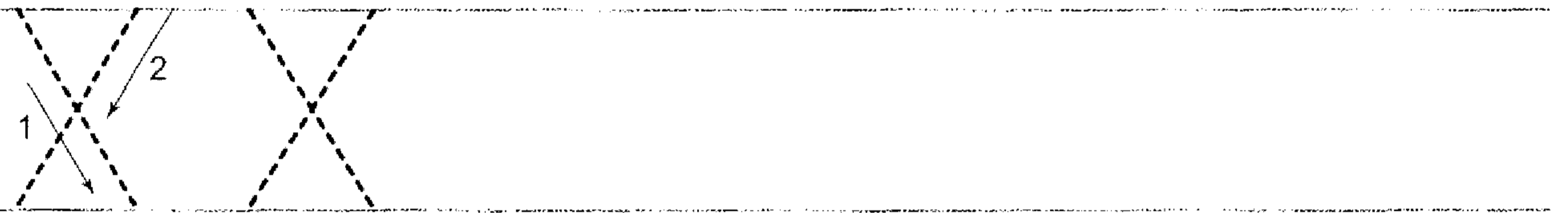

Выполни штриховку этих предметов прямыми линиями, оставляя окошечки незаштрихованными. Раскрась картинки.

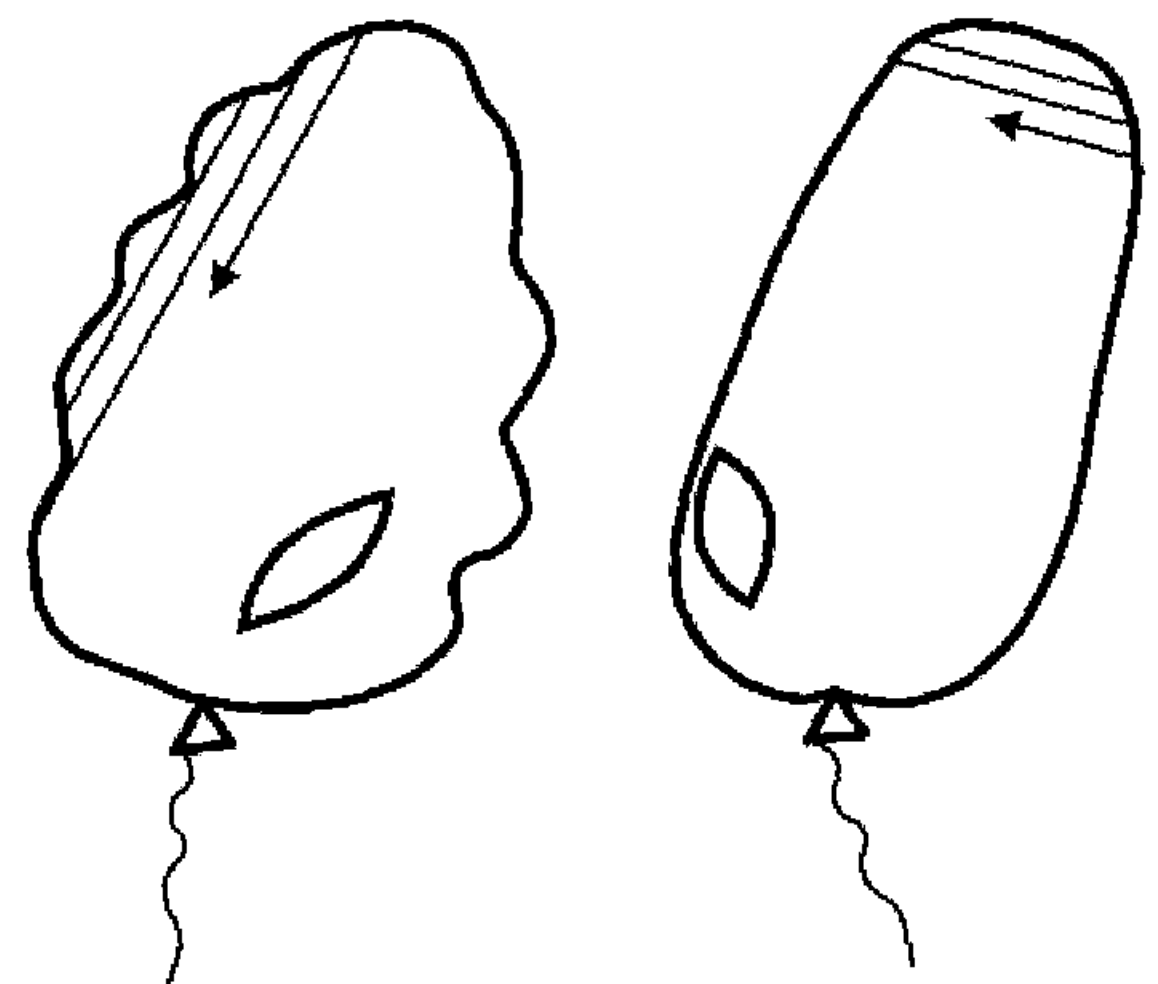
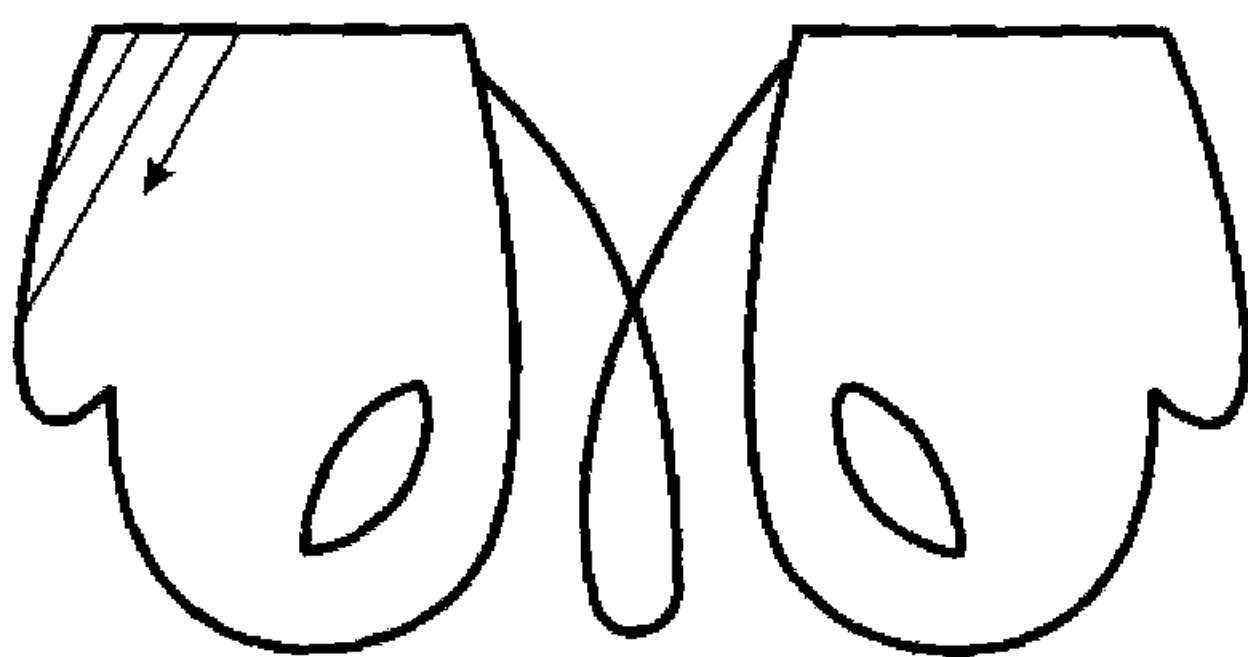
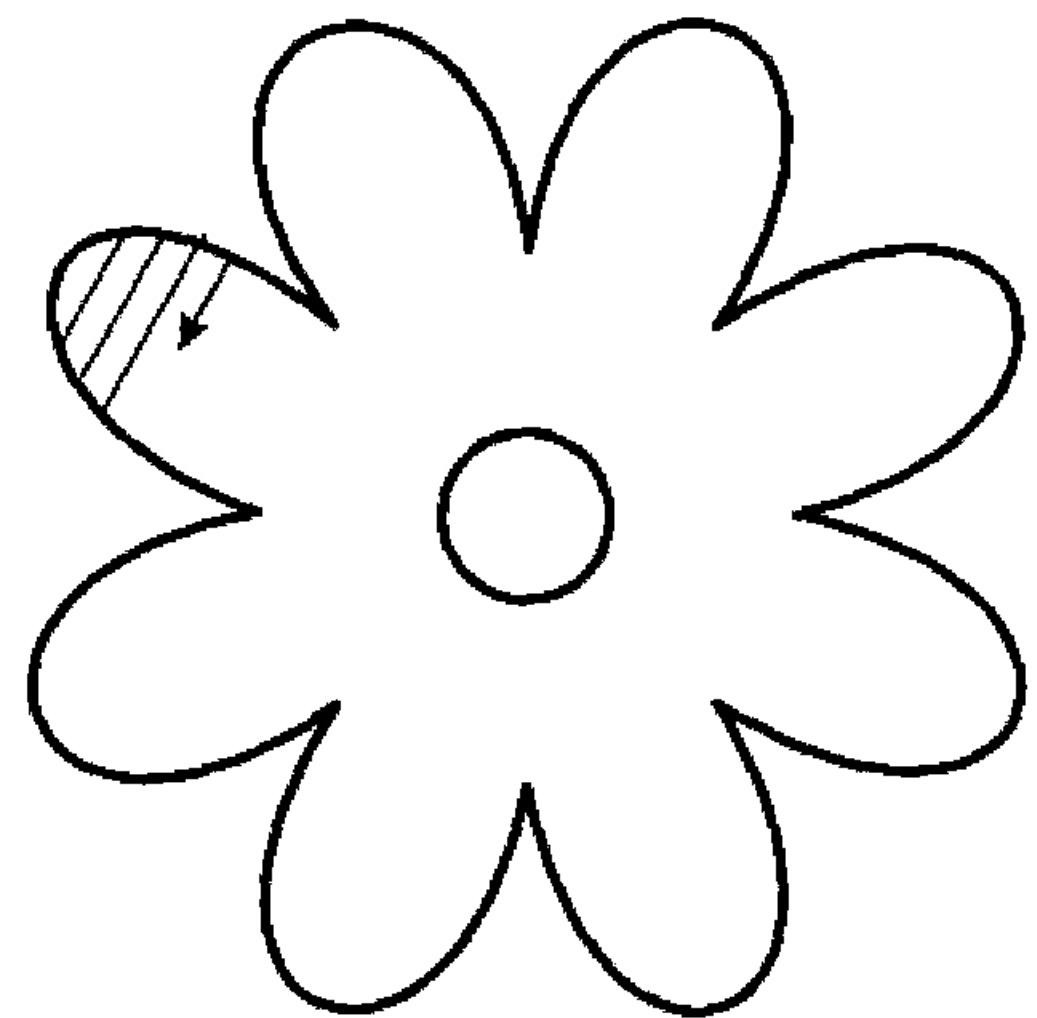
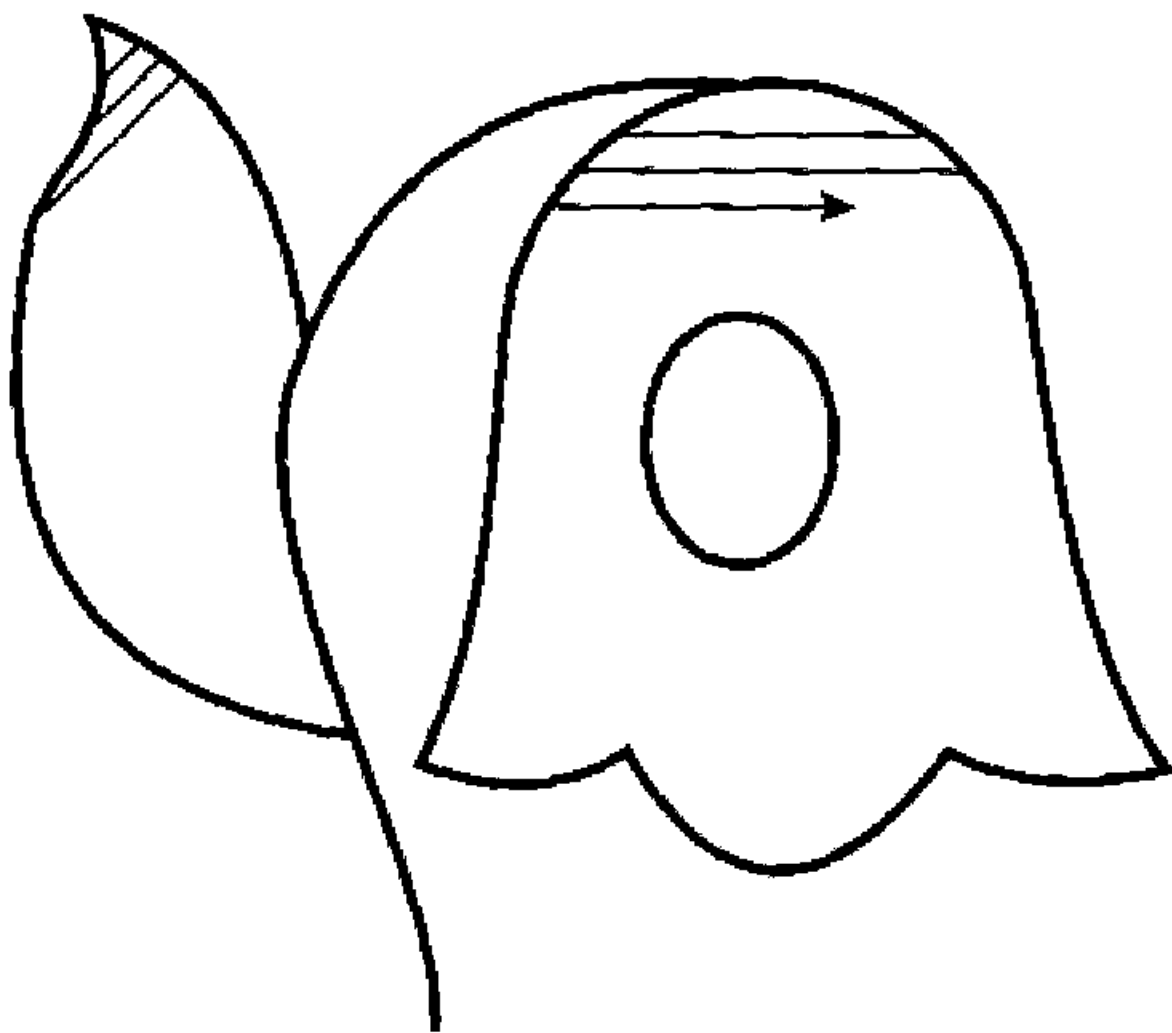
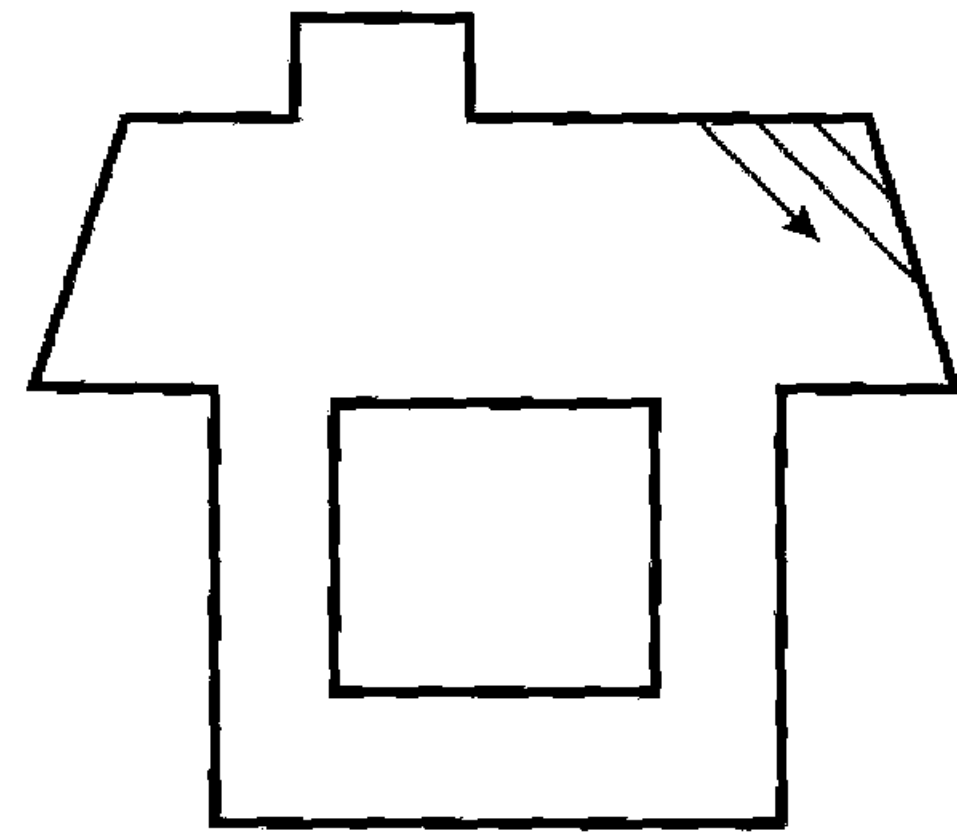
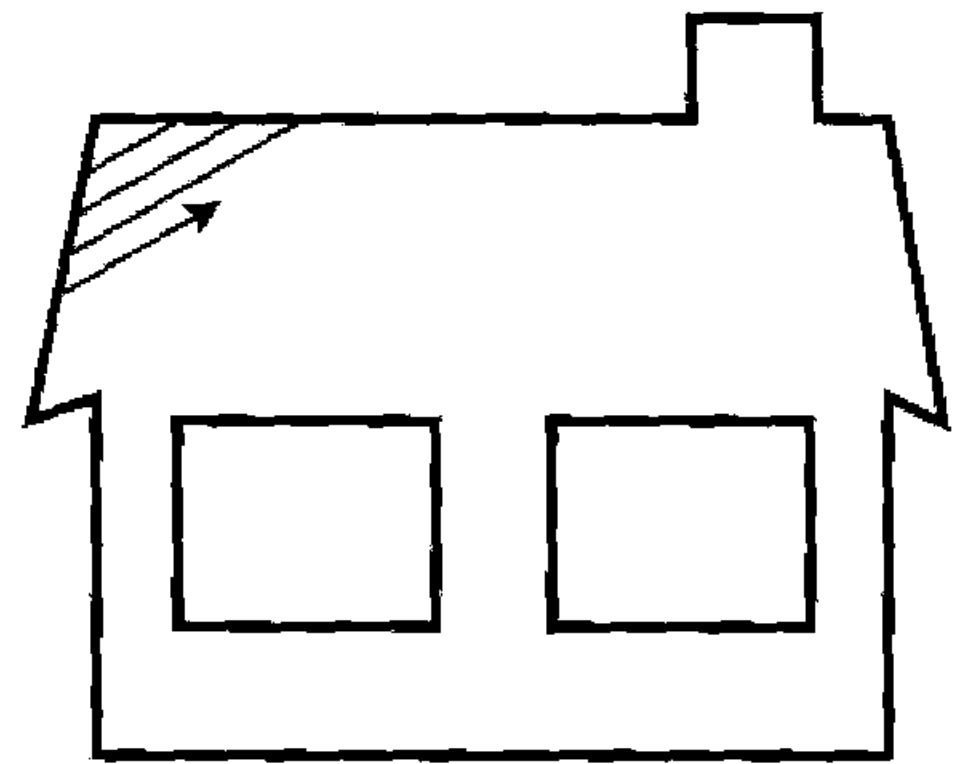
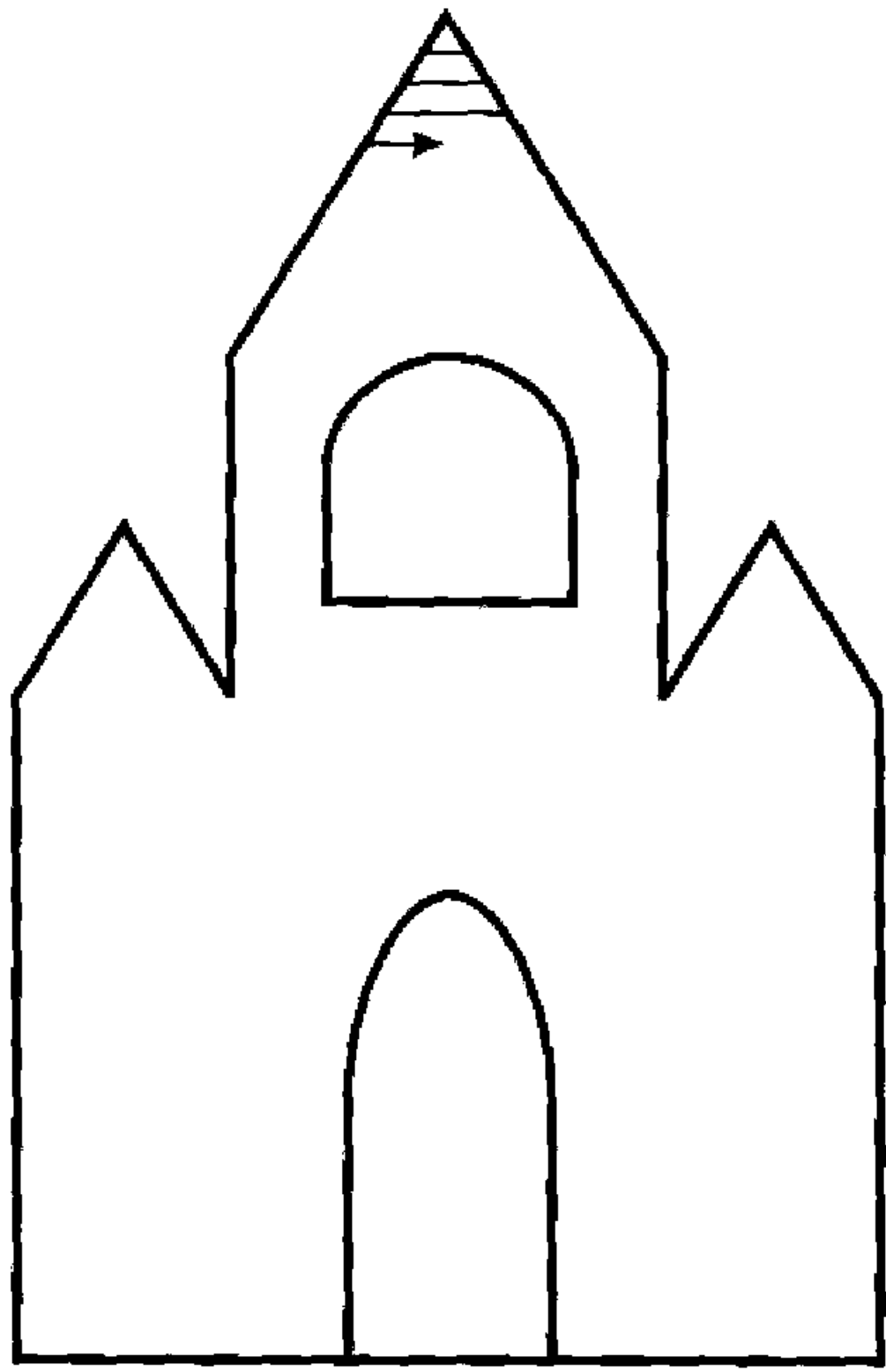

Щ

Щапля

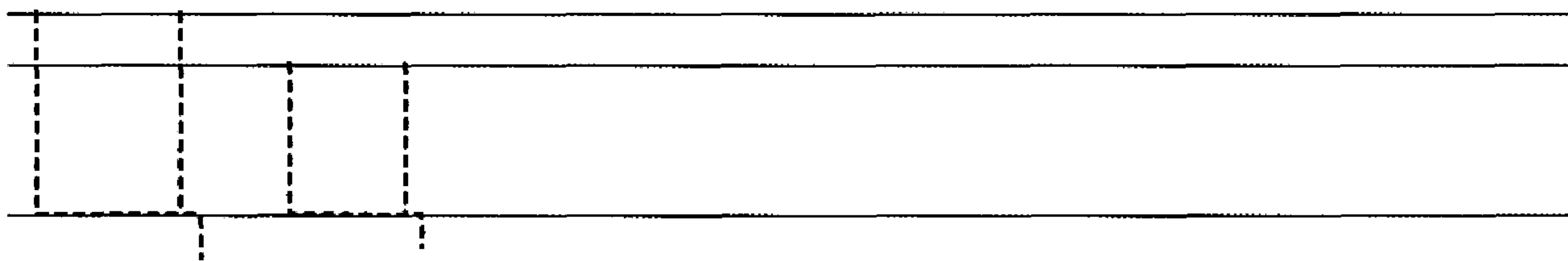
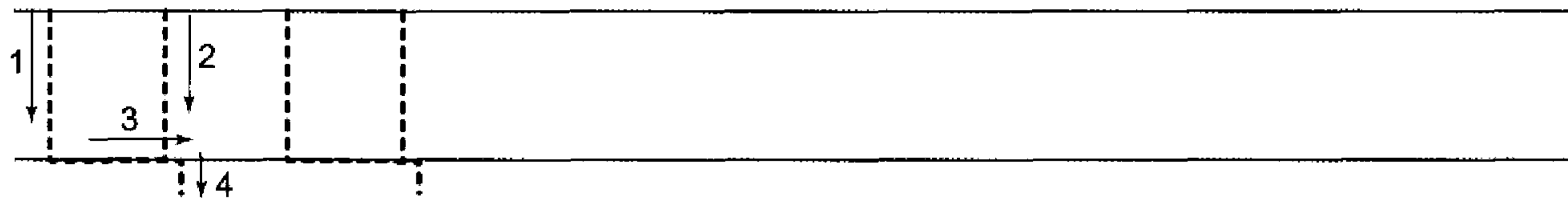
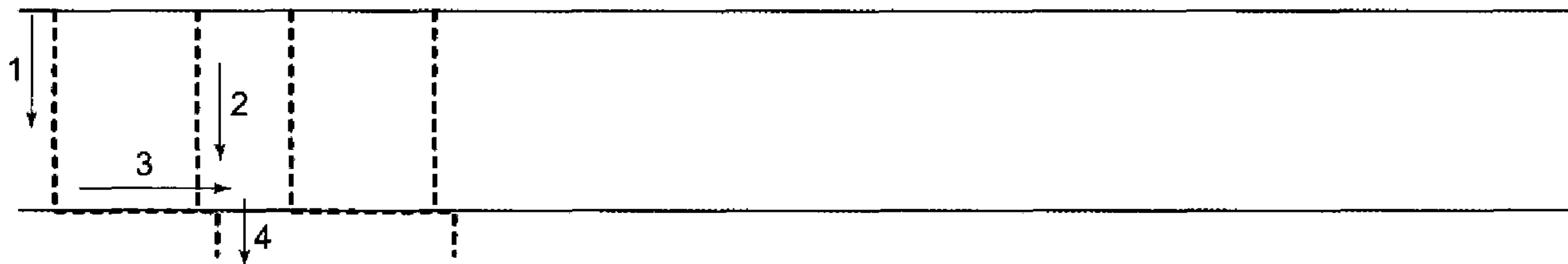
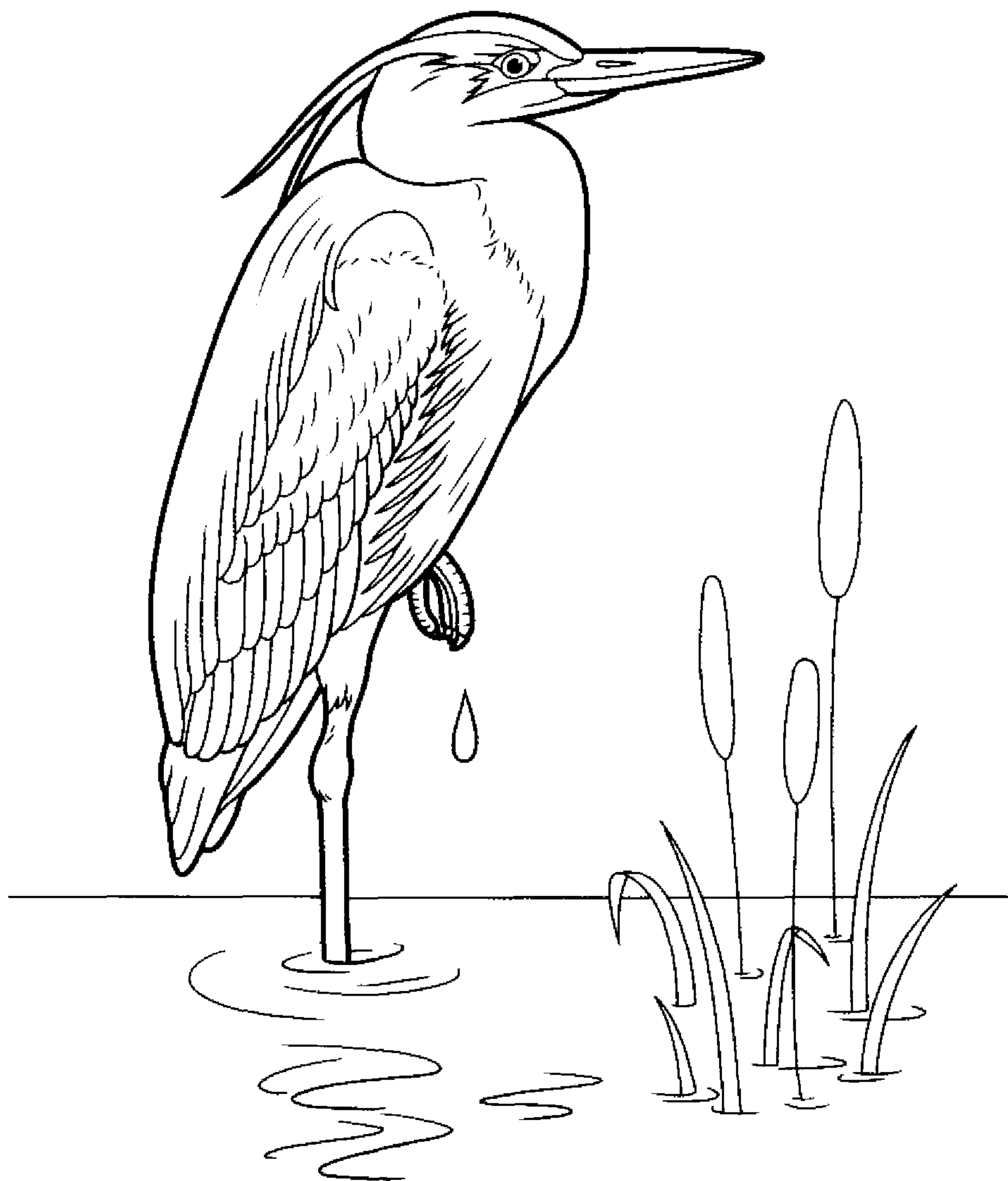

4

Черепаха

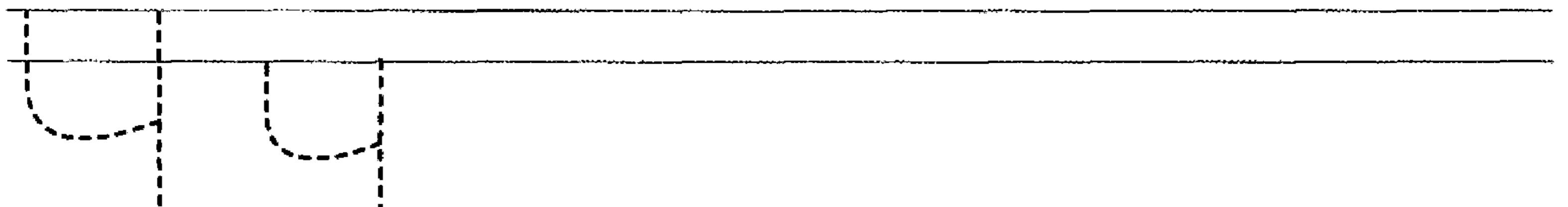
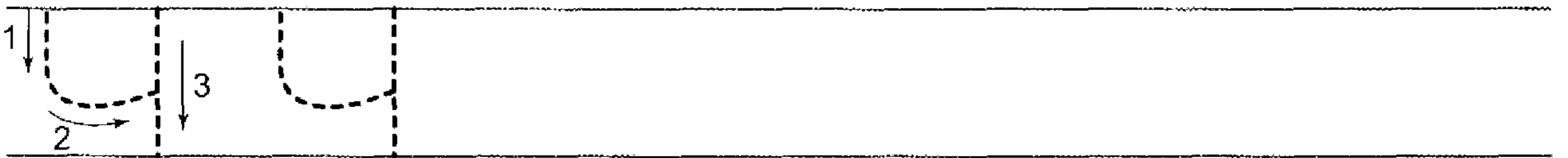
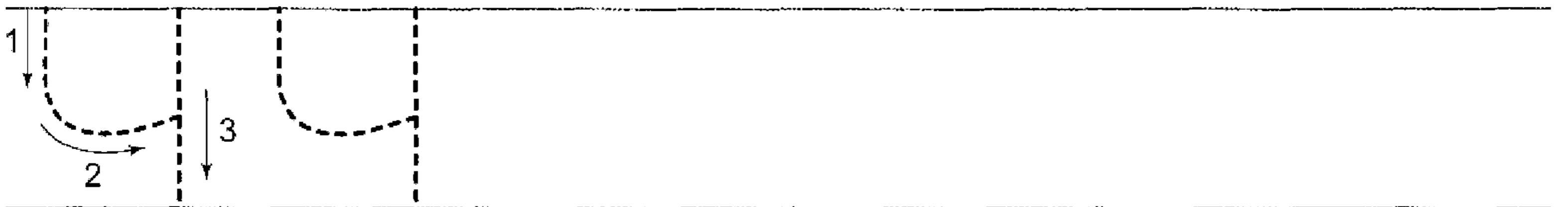
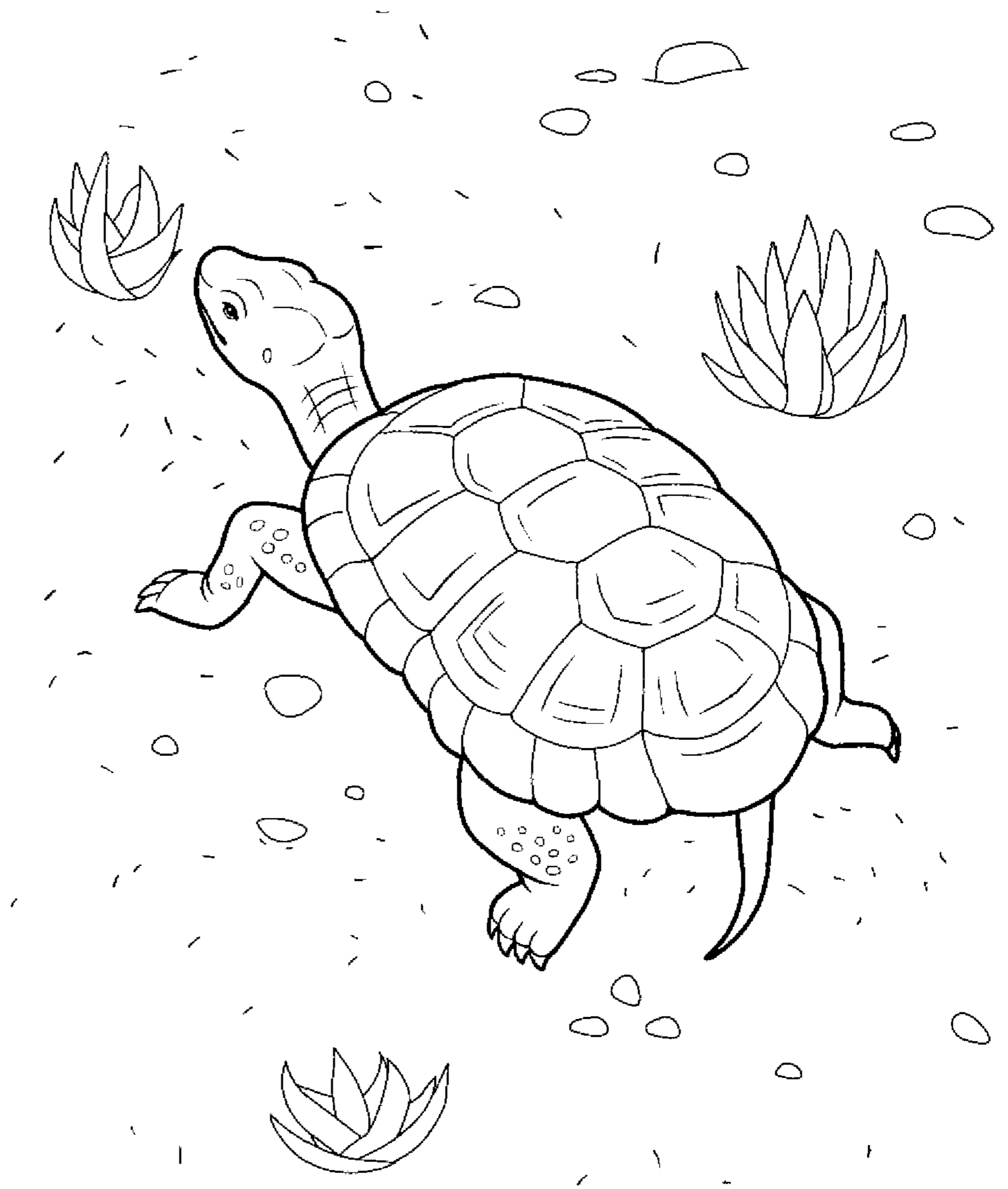

Обведи рисунки точно по линиям, не отрывая карандаш от бумаги. Раскрась картинки.

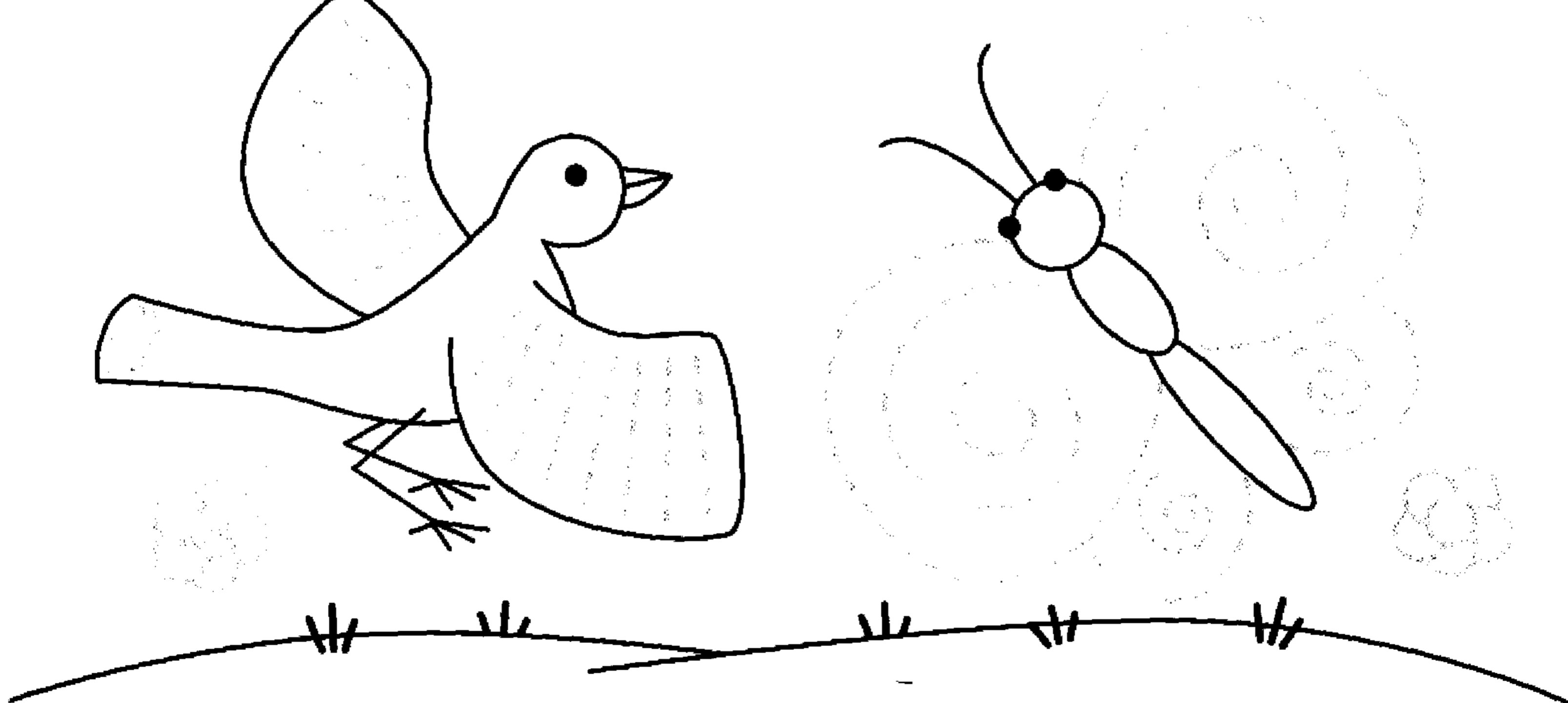
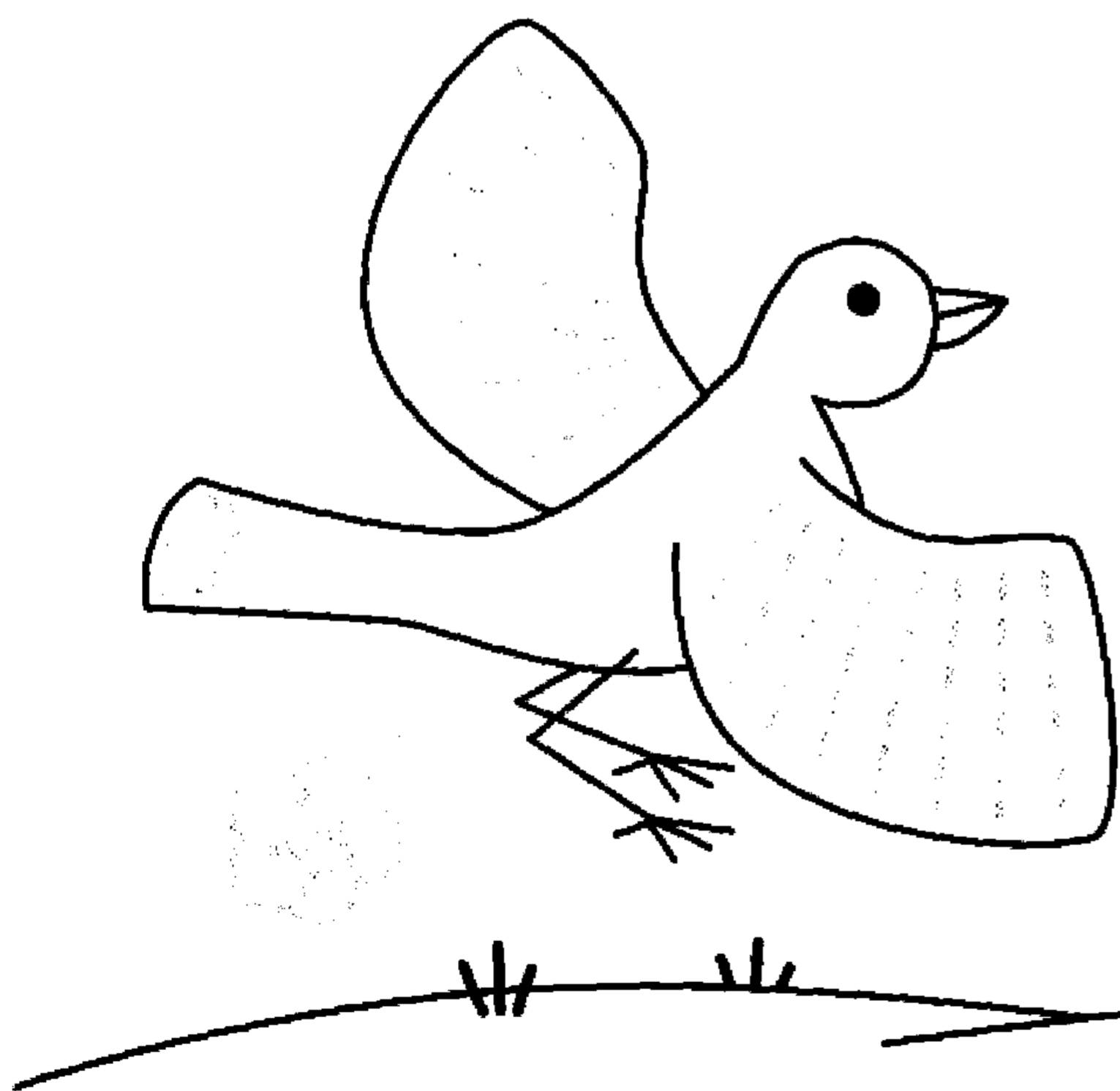
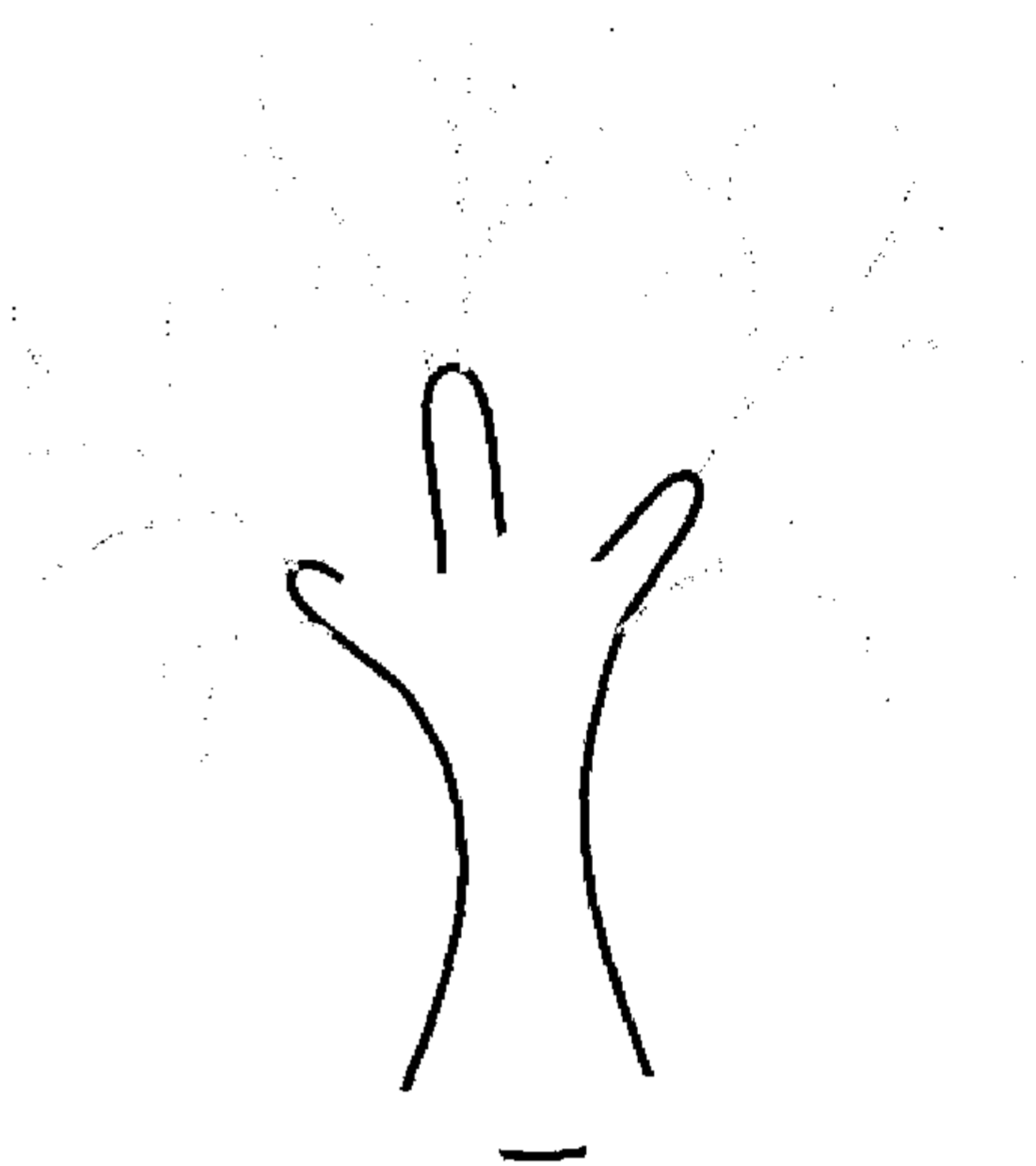
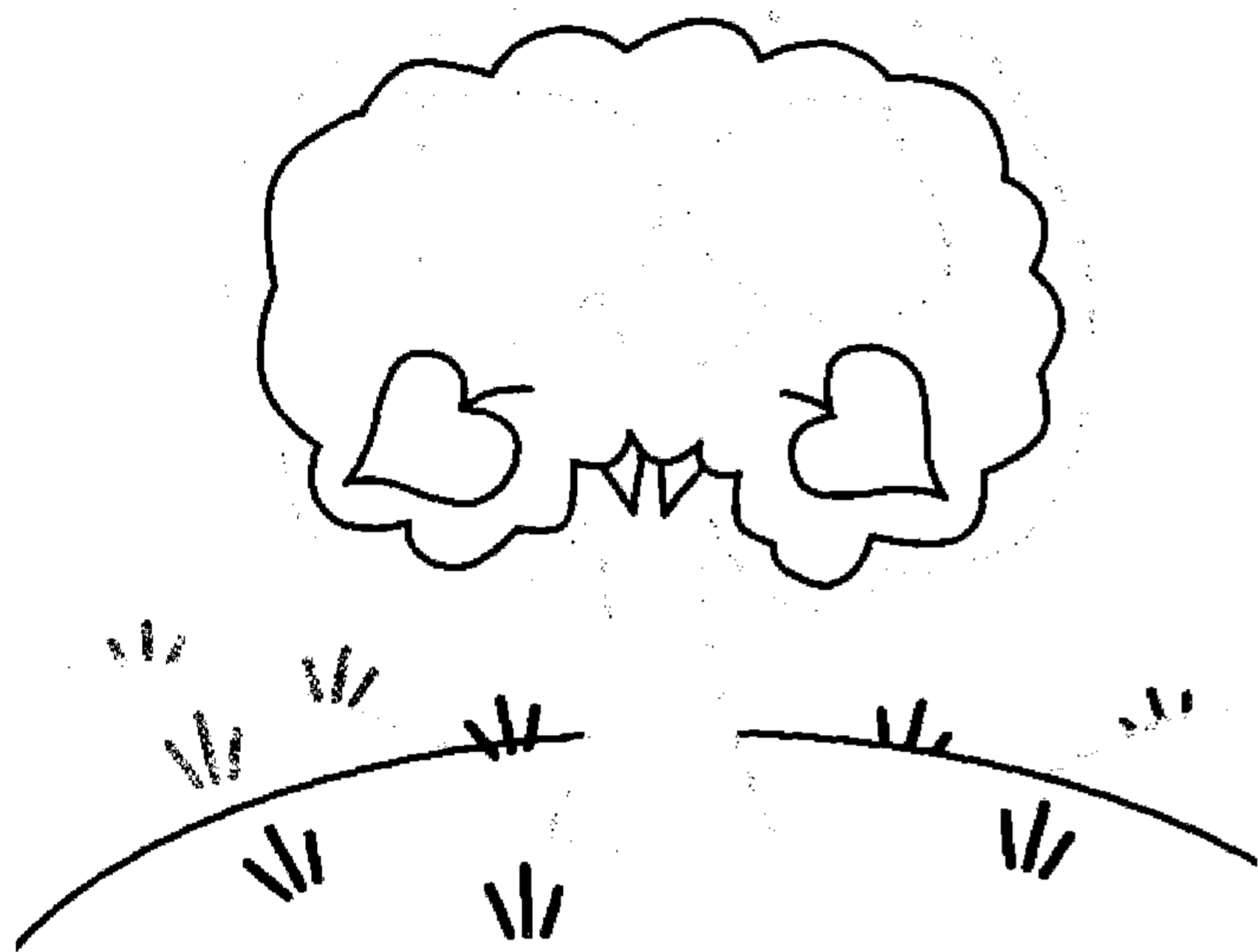

Ш Ш Ш

Шмель

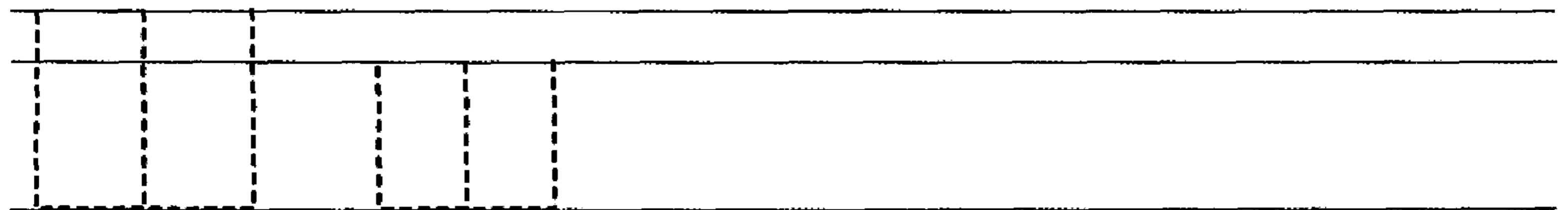
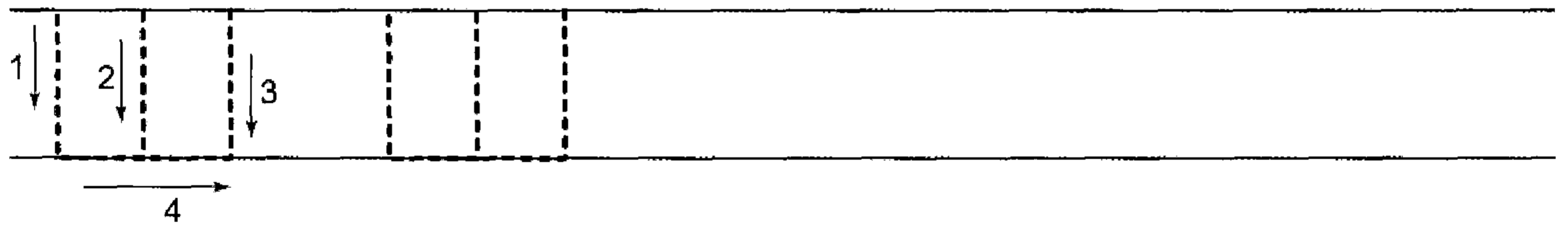
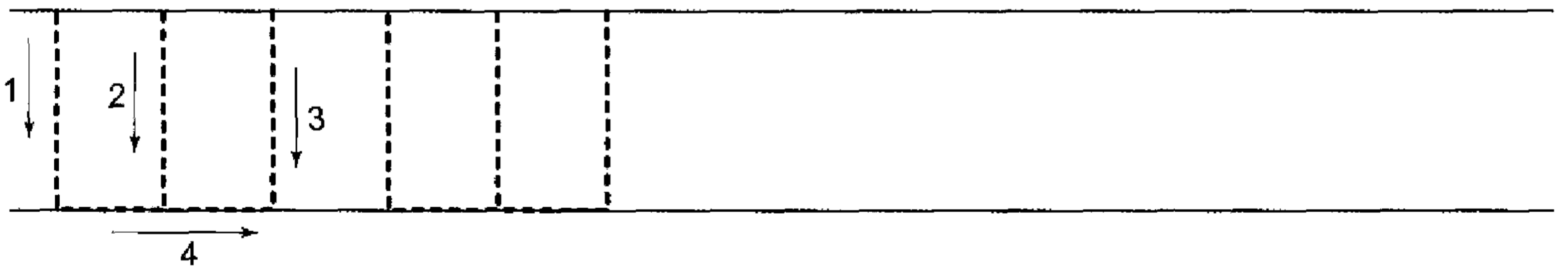
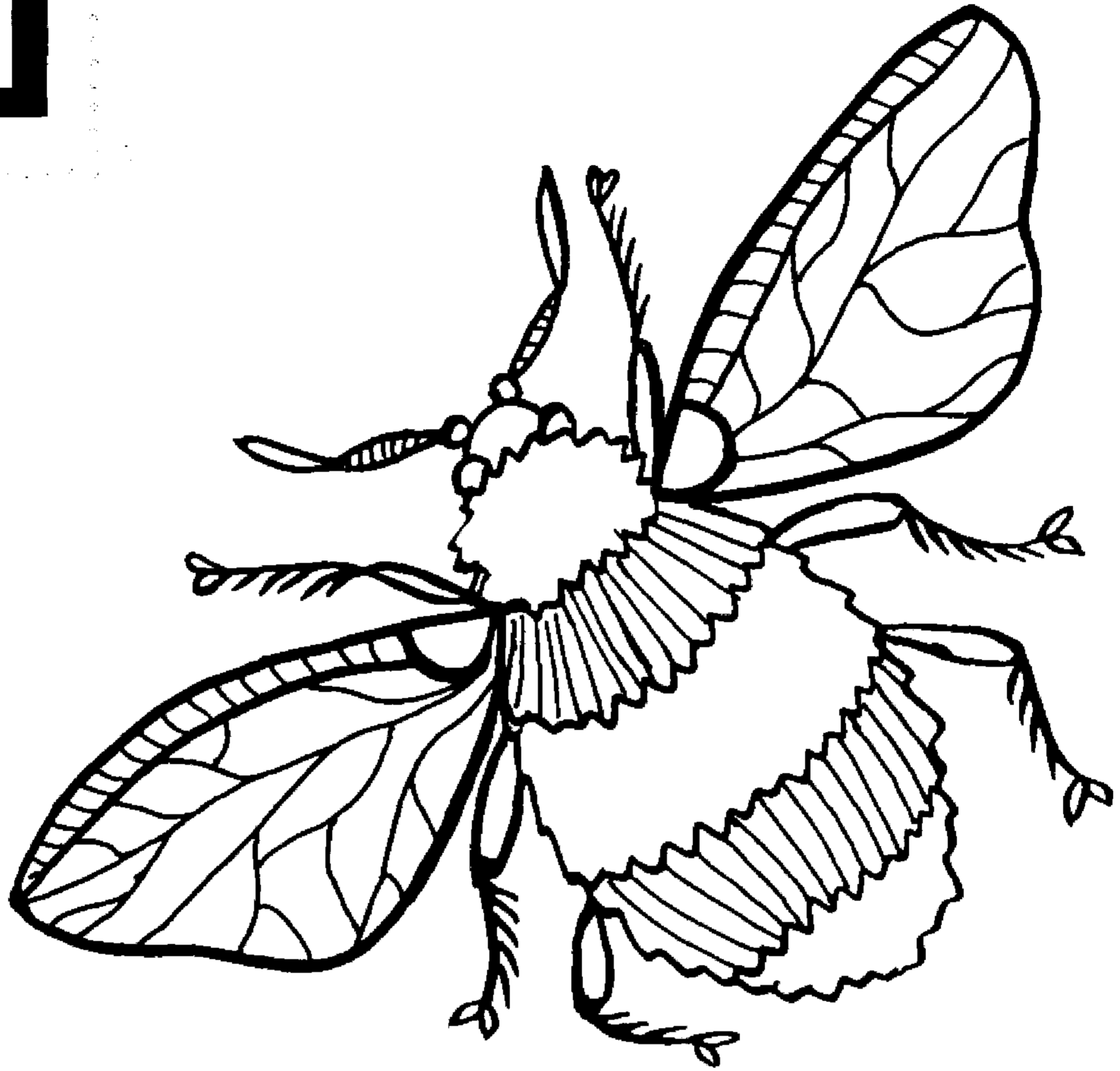

Дорисуй картинку. Соедини линии по точкам и раскрась.

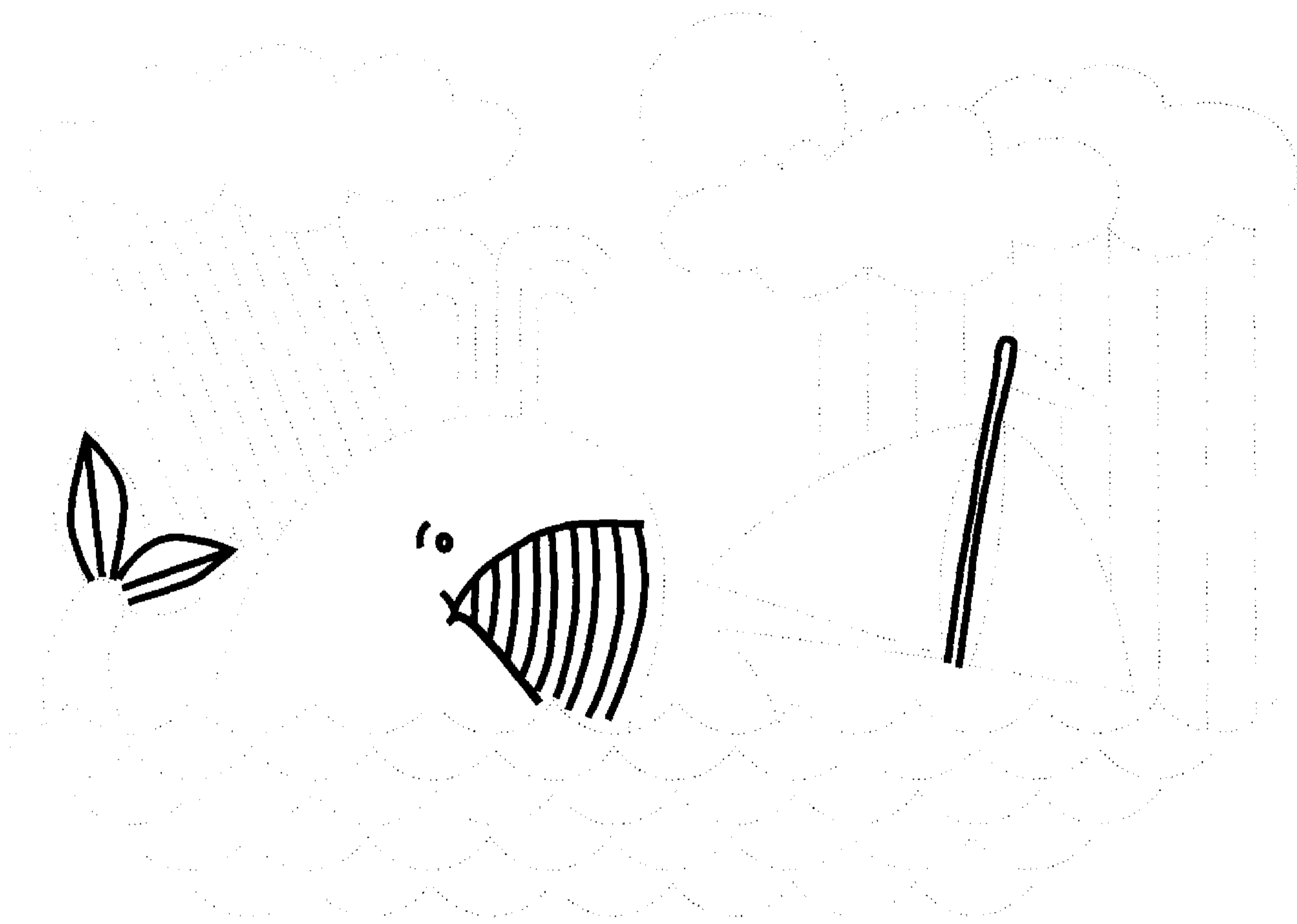

Выполни штриховку прямыми линиями, не выходя за контур рисунка, и раскрась.

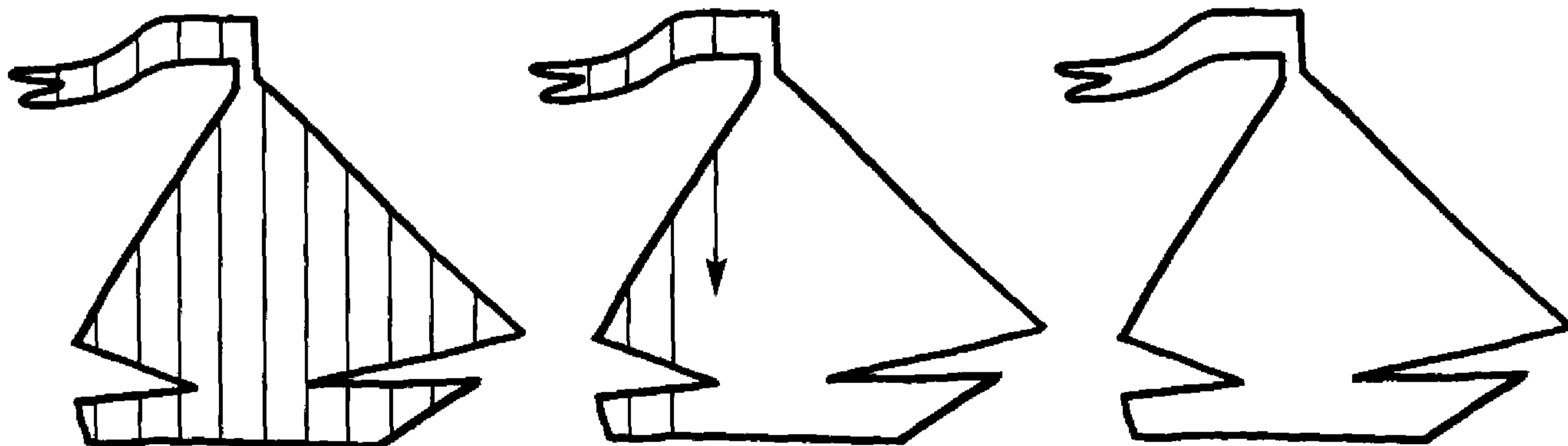

ЩЩЩ

Щенок

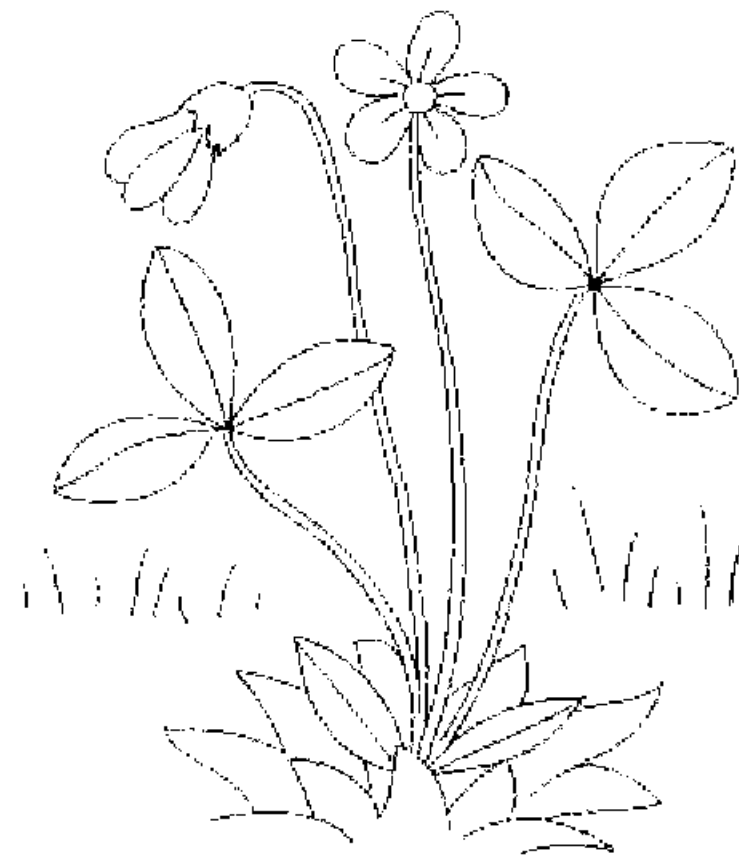

Tracing practice lines for the Cyrillic letter 'Щ'. The first two rows show the stroke order: 1 (vertical down), 2 (vertical down), 3 (vertical down), 4 (horizontal right), and 5 (vertical down). The third row is a blank template for practice.

Нарисуй узоры на рукавичках, шарфике и шапочке. Раскрась картинку.



Ъ

Нет такого животного, в названии
которого была бы буква «Ъ».
Нарисуй любое животное
и раскрась его.

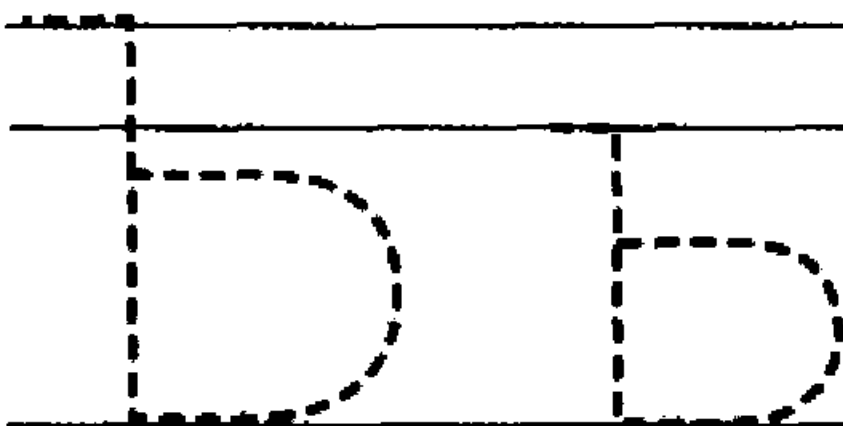
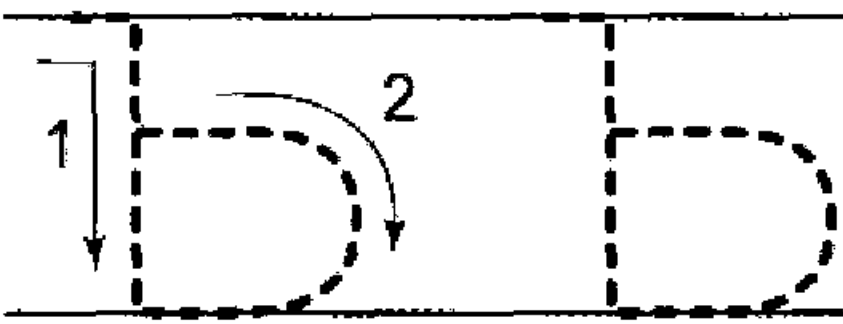
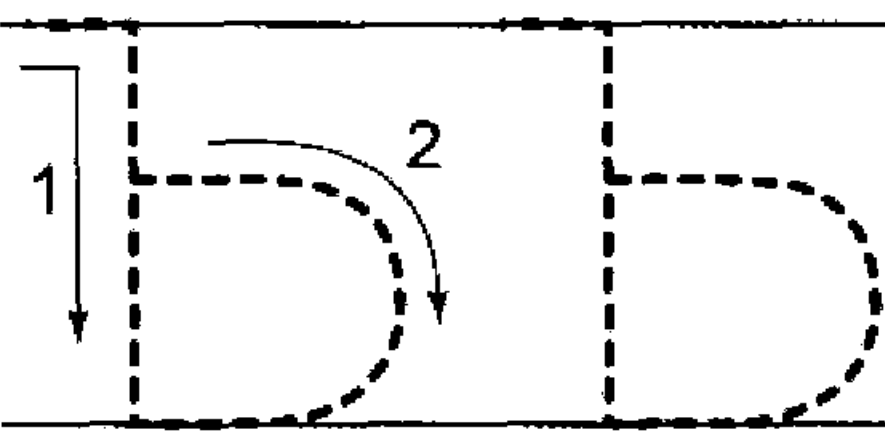

б

Олень

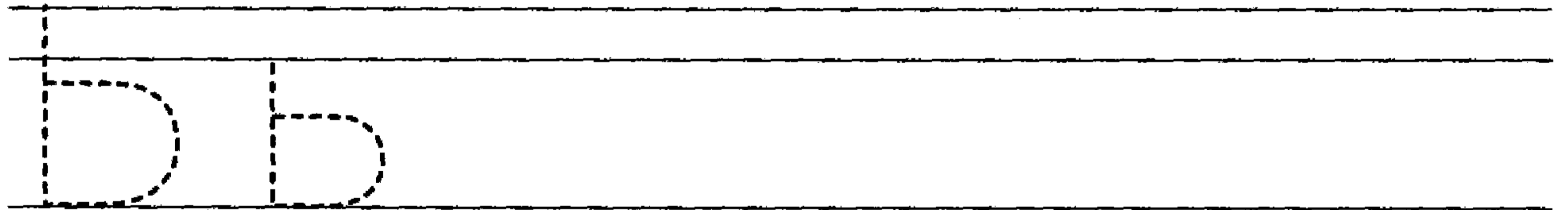
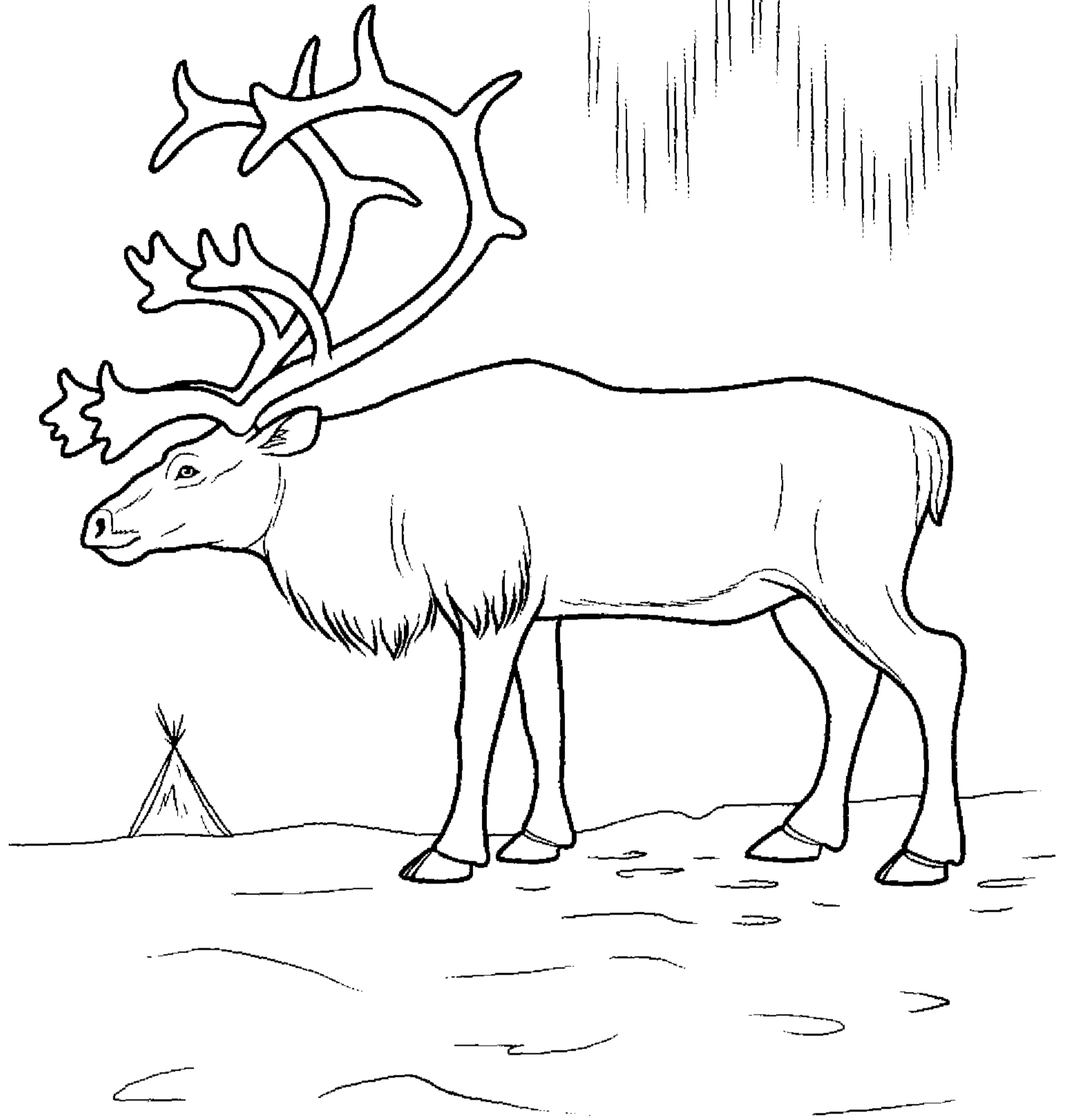

Ы

Выдра

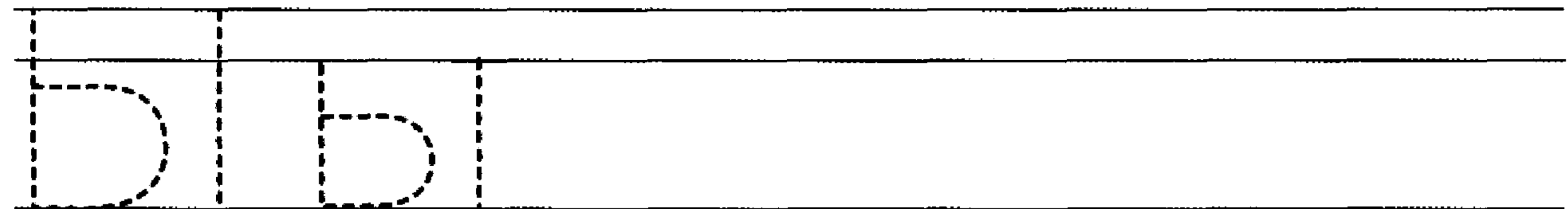
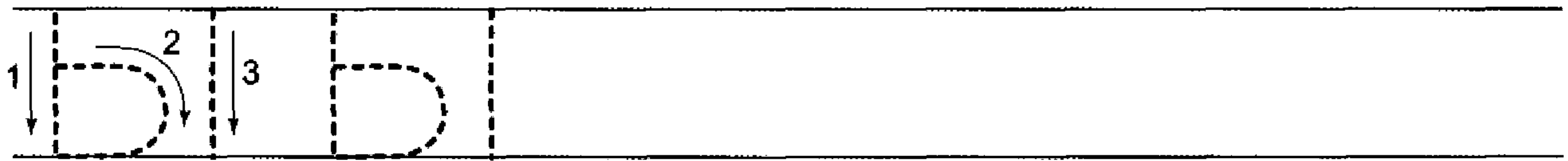
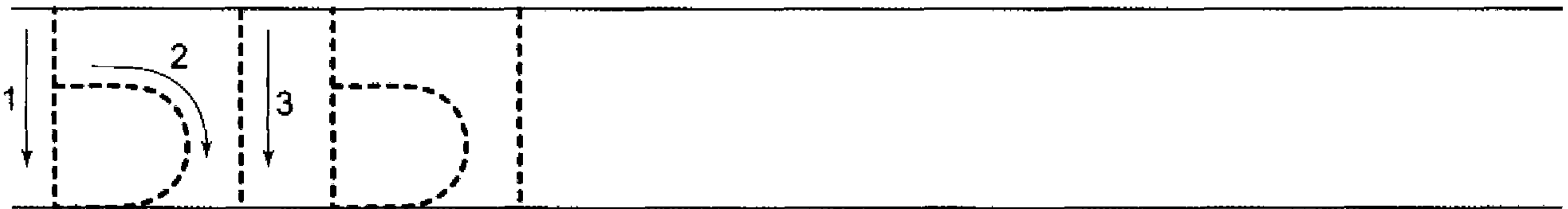

Обведи картинки по пунктирным линиям. Раскрась их.

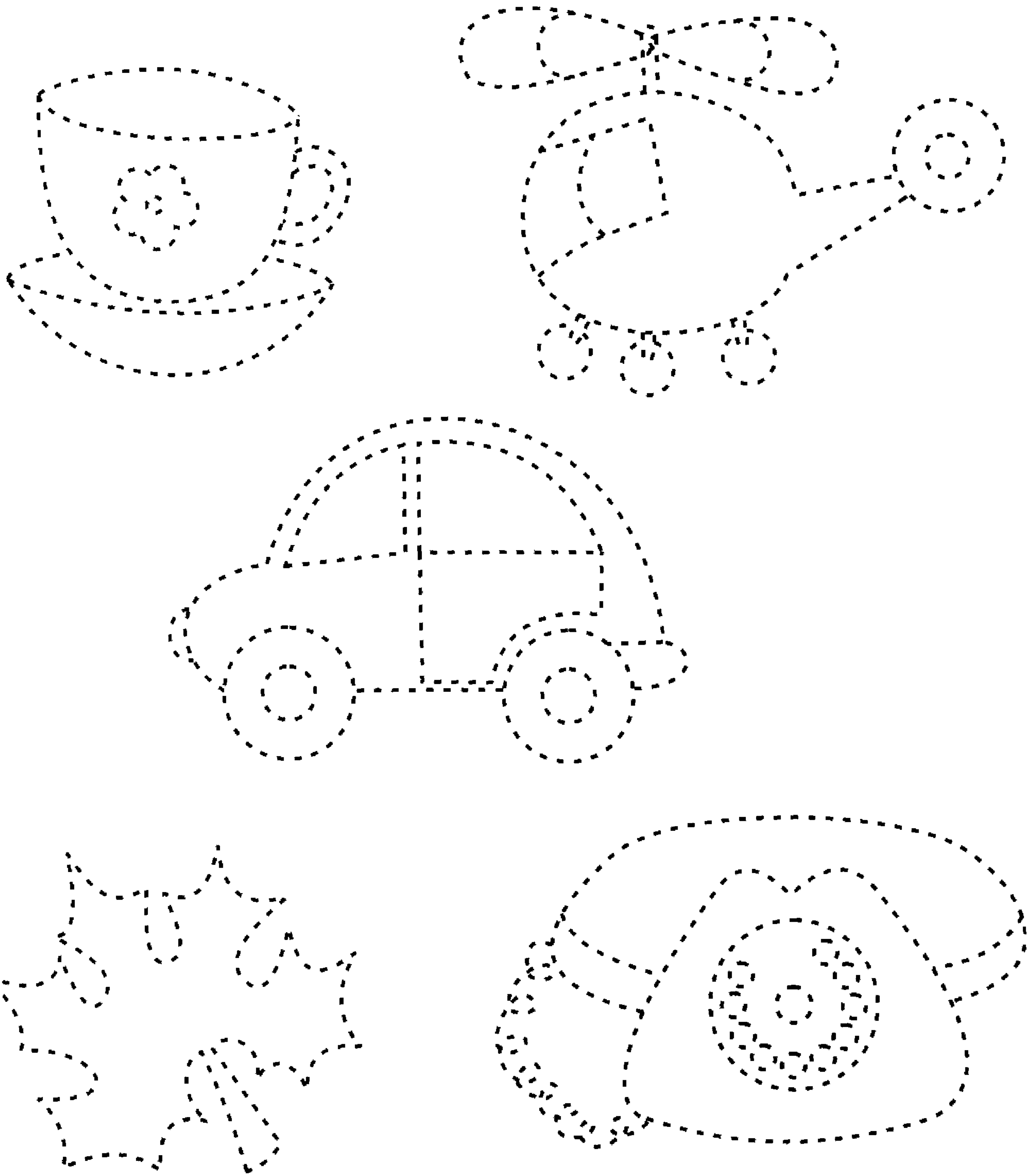

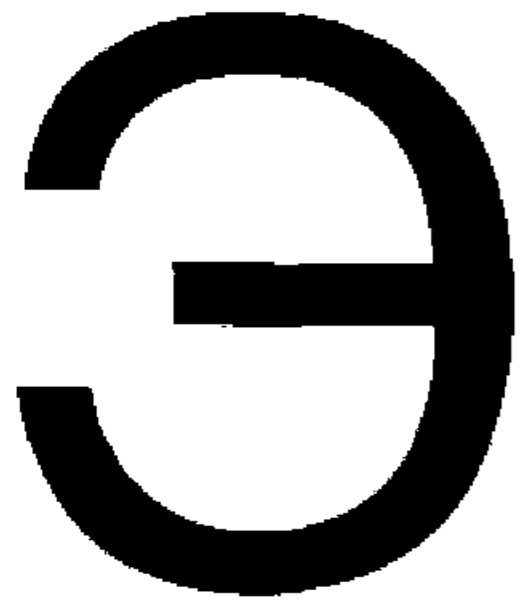

Нет такого животного, в названии
которого была бы буква «Э».
Нарисуй любое животное
и раскрась его.

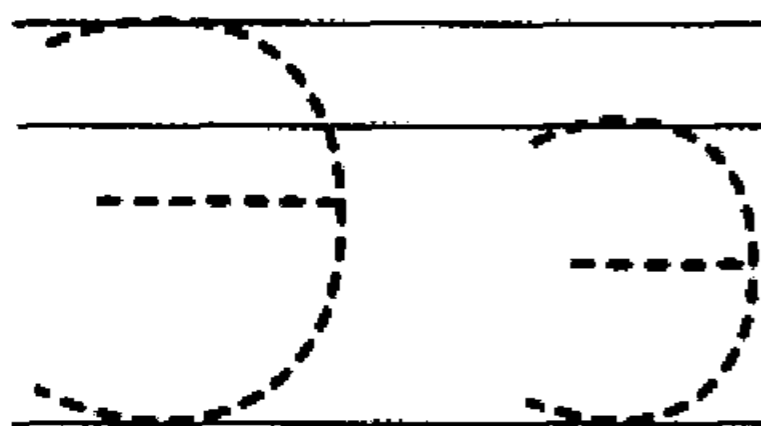
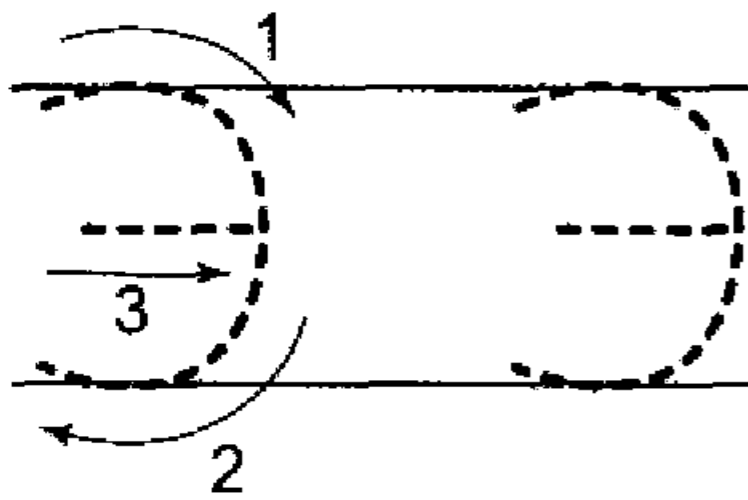
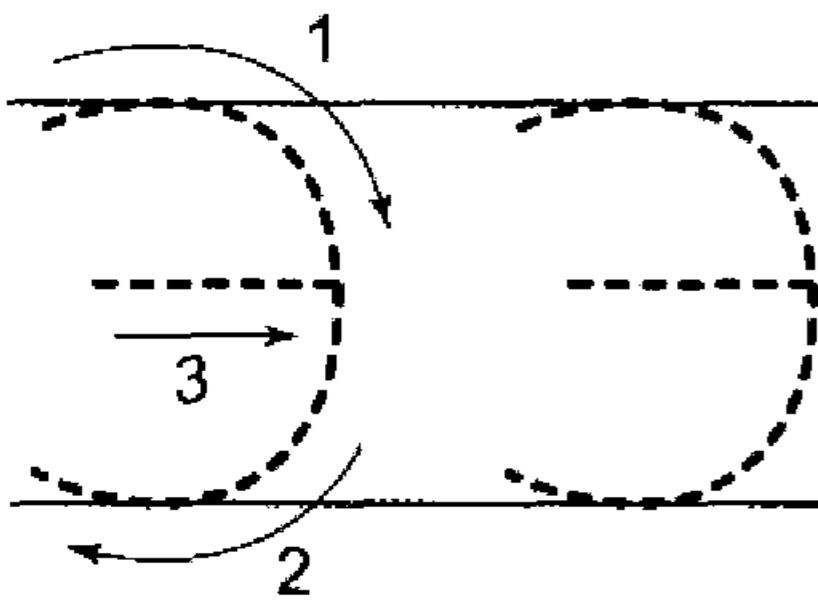

Ю

Тюлень

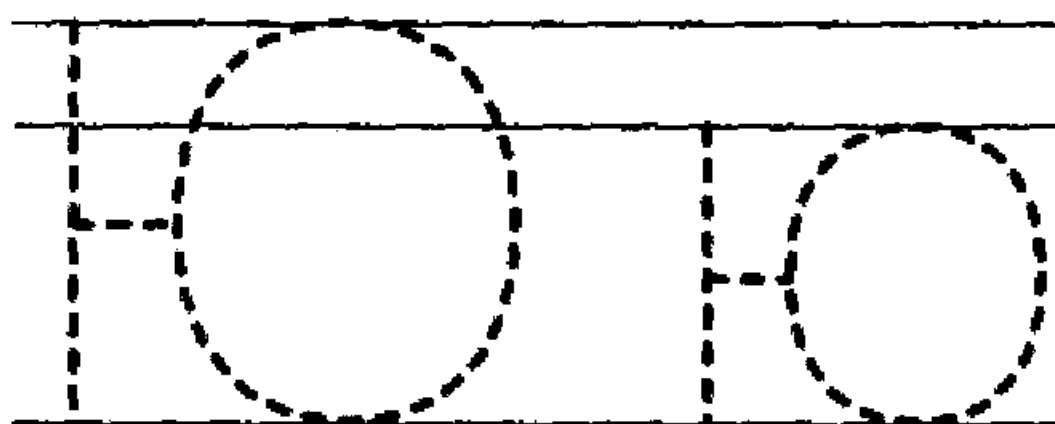
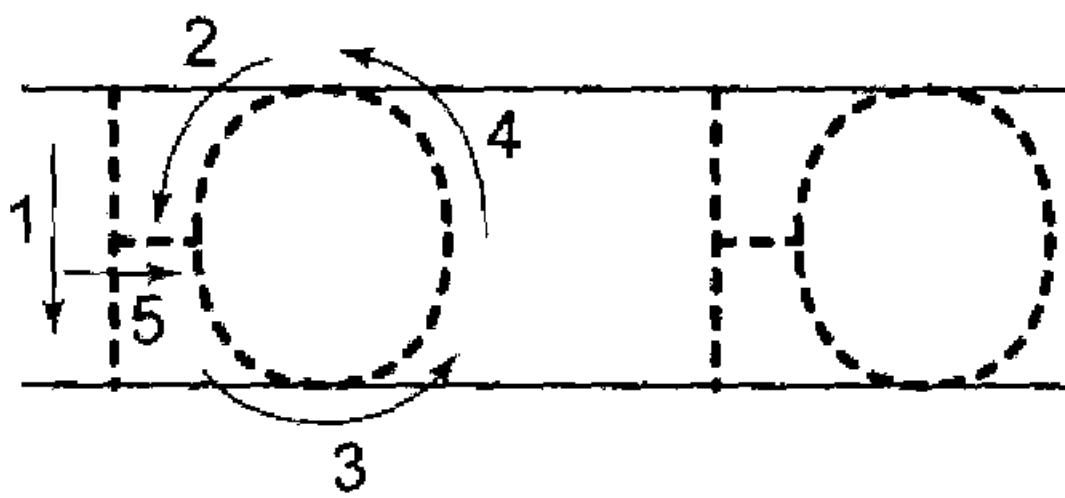
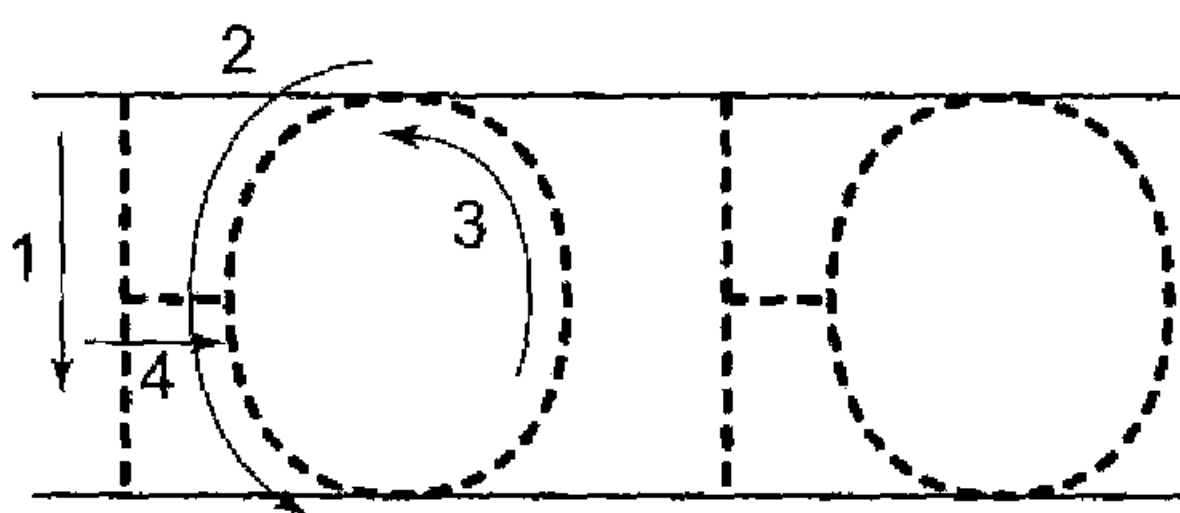
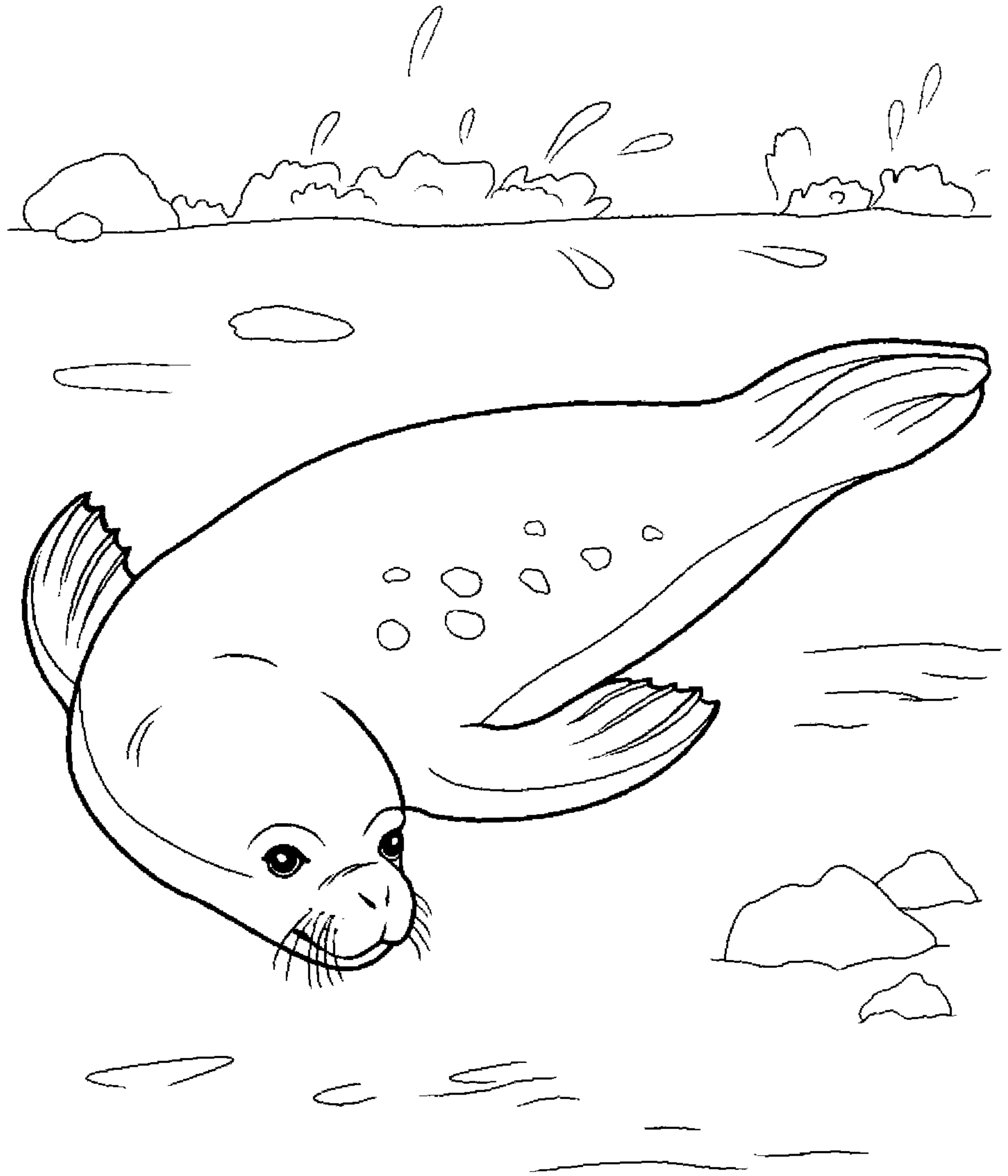

Дорисуй картинки по пунктирным линиям и раскрась.

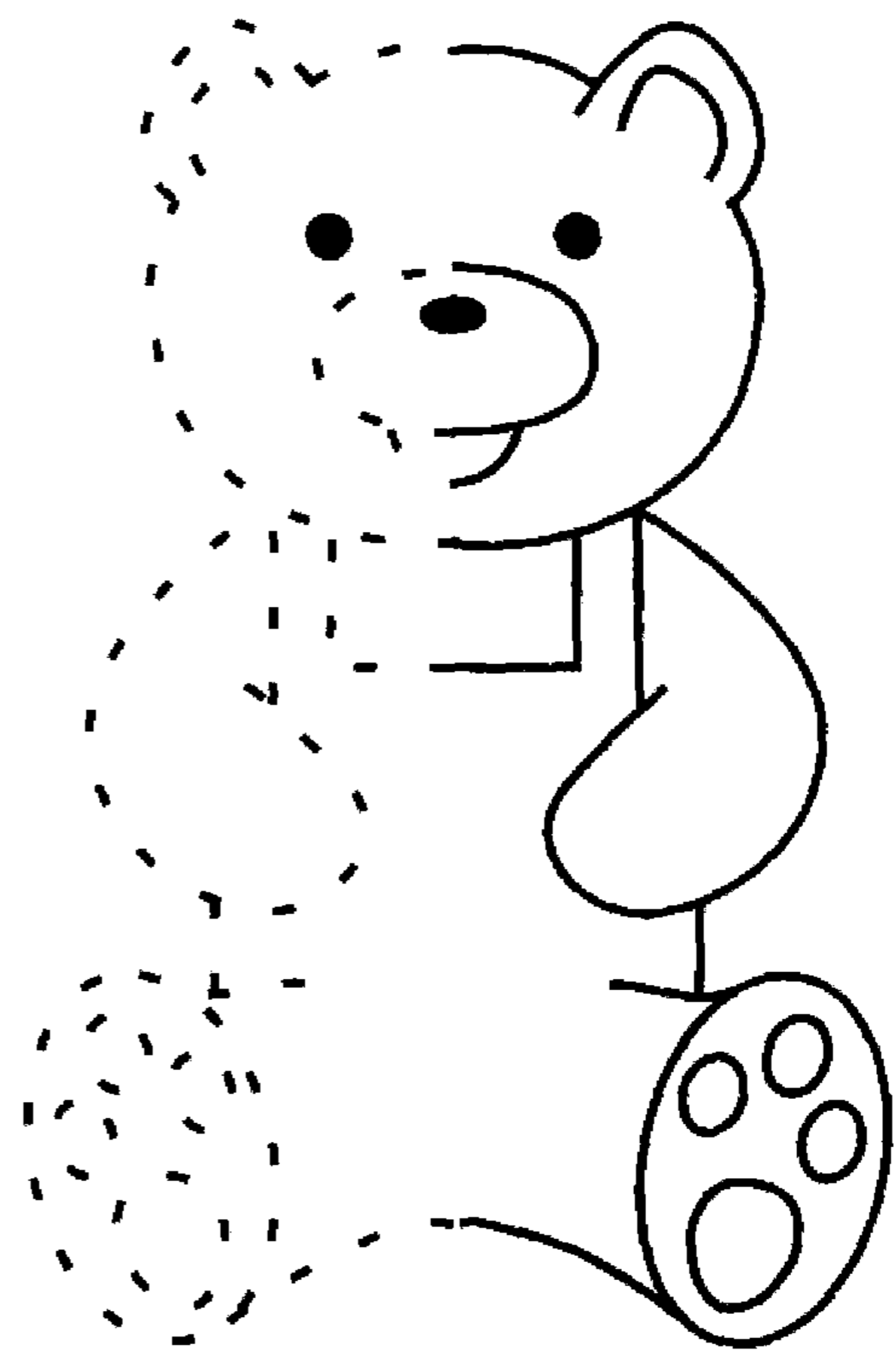
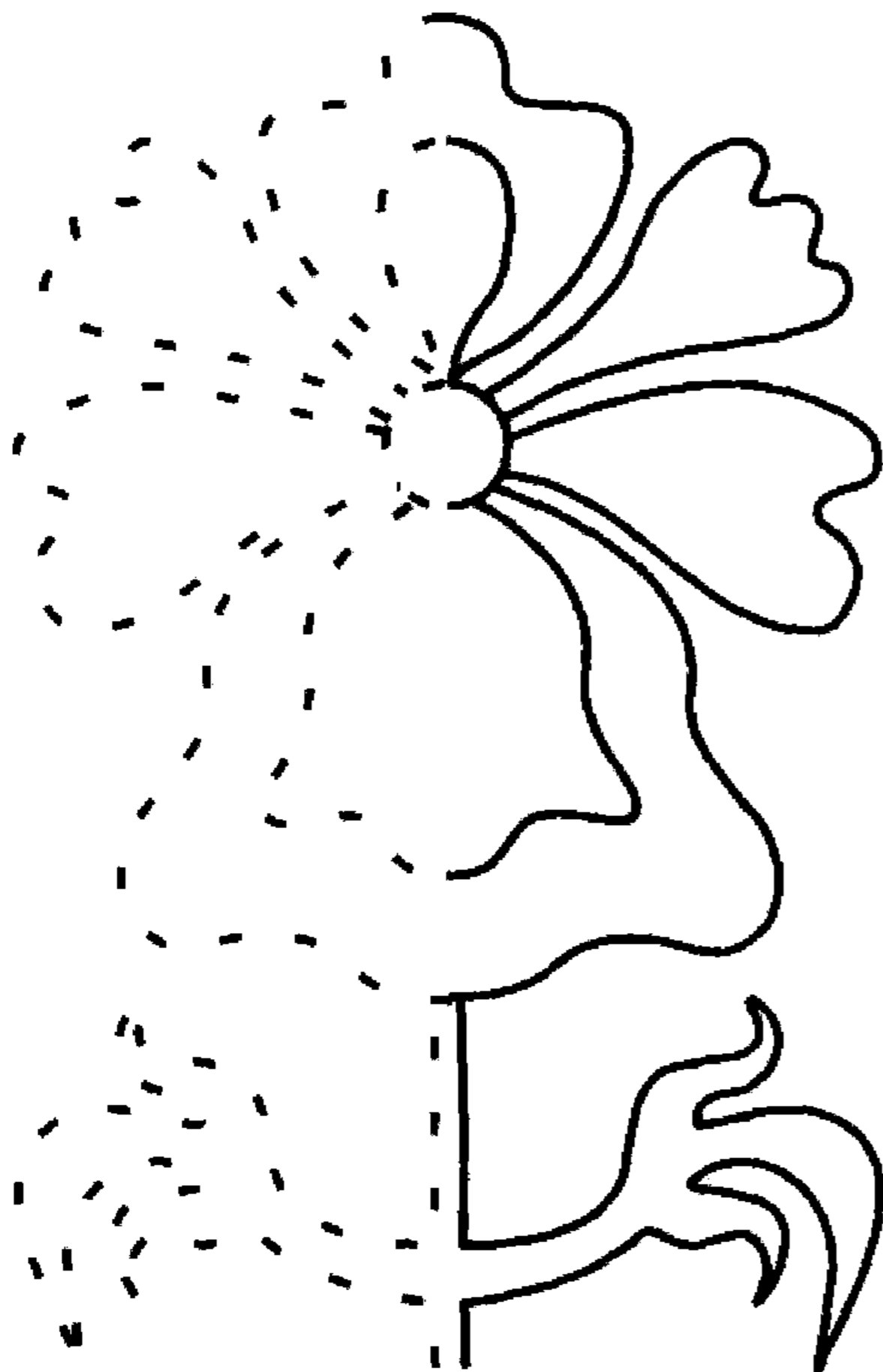
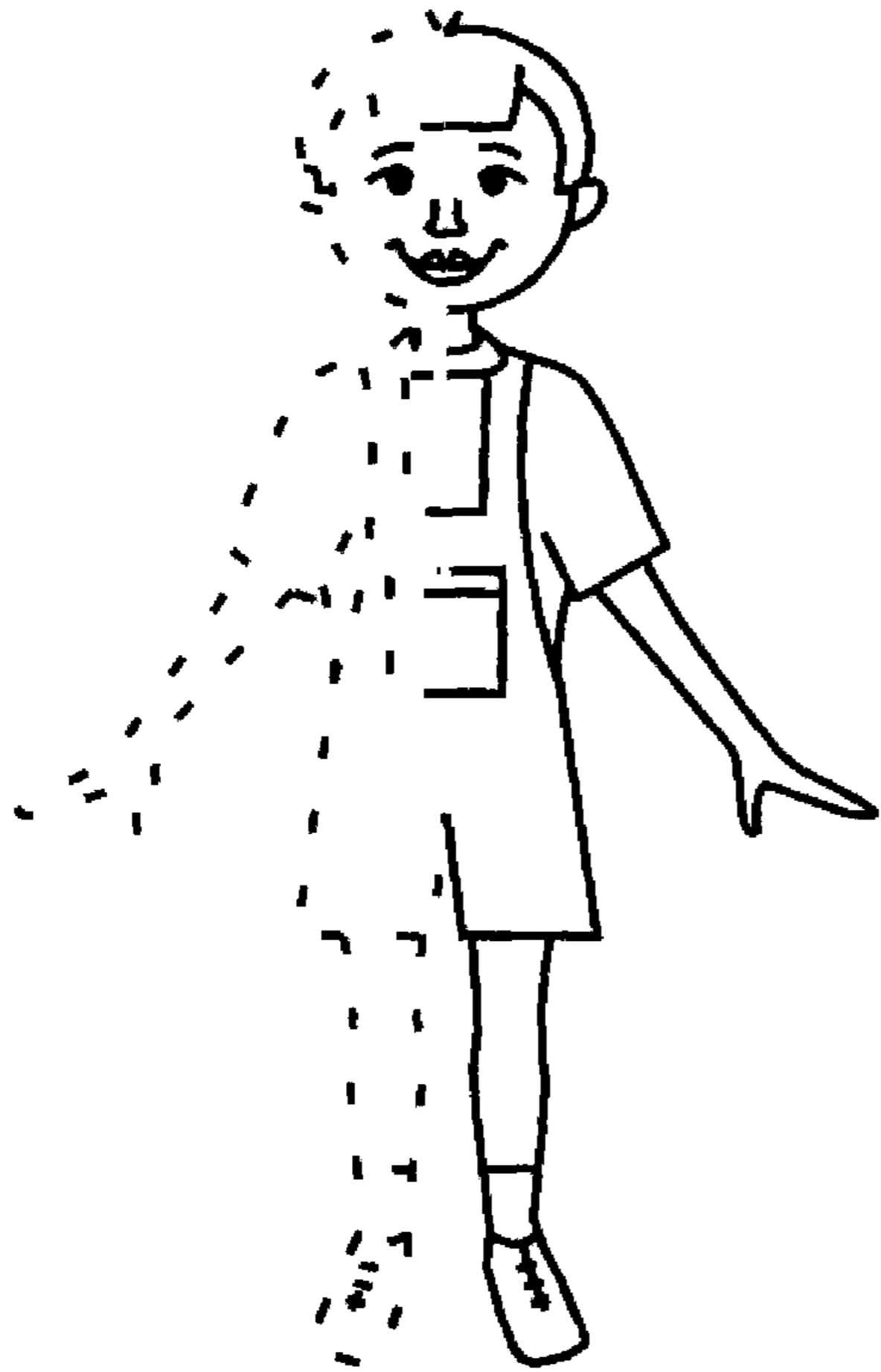

Соедини буквы от А до Я. Раскрась рисунок.

